

JPL D-7669, Part 2

# Planetary Data System Standards Reference

August 1, 2003  
Version 3.6



Jet Propulsion Laboratory  
California Institute of Technology  
Pasadena, California

# PDS Standards Reference

## Table of Contents

<b>Chapter 1.</b>	<b>Introduction.....</b>	<b>1-1</b>
1.1	PDS Data Policy .....	1-1
1.2	Purpose.....	1-1
1.3	Scope.....	1-2
1.4	Audience .....	1-2
1.5	Document Organization .....	1-2
1.6	Other Reference Documents .....	1-2
1.7	Online Document Availability .....	1-3
<b>Chapter 2.</b>	<b>Cartographic Standards.....</b>	<b>2-1</b>
2.1	Inertial Reference Frame, Time Tags and Units .....	2-1
2.2	Spin Axes and Prime Meridians .....	2-1
2.3	Reference Coordinates .....	2-2
2.4	Rings .....	2-3
2.5	Reference Surface .....	2-5
2.6	Map Resolution.....	2-5
2.7	References.....	2-5
<b>Chapter 3.</b>	<b>DATA_TYPE Values and Data File Storage Formats .....</b>	<b>3-1</b>
3.1	Data Elements .....	3-1
3.2	Data Types .....	3-1
3.3	Binary Integers.....	3-4
3.4	Signed vs. Unsigned Integers.....	3-4
3.5	Floating Point Formats.....	3-5
3.6	Bit String Data .....	3-5
3.7	Character Data .....	3-5
3.8	Format Specifications .....	3-5
3.9	Internal Representations of Data Types .....	3-6
<b>Chapter 4.</b>	<b>Data Objects and Products .....</b>	<b>4-1</b>
4.1	Data Product File Configurations .....	4-2
<b>Chapter 5.</b>	<b>Data Product Labels .....</b>	<b>5-1</b>
5.1	Format of PDS Labels.....	5-1
5.1.1	Labeling methods.....	5-1
5.1.2	Label format.....	5-3
5.2	Data Product Label Content.....	5-4
5.2.1	Attached and Detached Labels.....	5-4
5.2.2	Combined Detached Labels .....	5-6
5.2.3	Minimal Labels .....	5-8
5.3	Detailed Label Contents Description .....	5-10
5.3.1	Label Standards Identifiers .....	5-10

5.3.2	File Characteristic Data Elements.....	5-11
5.3.3	Data Object Pointers .....	5-12
5.3.4	Data Identification Elements.....	5-15
5.3.5	Descriptive Data Elements.....	5-17
5.3.6	Data Object Definitions .....	5-17
5.3.7	End Statement .....	5-18
5.4	Syntax for Element Values .....	5-18
5.5	Locally-defined Data Elements.....	5-19
5.5.1	Justification for Locally-defined Data Elements .....	5-19
5.5.2	Identification of Justification for Locally-defined Data Elements .....	5-19
5.5.3	Review and Use of Locally defined Data Elements .....	5-21
<b>Chapter 6.</b>	<b>Data Set/Data Set Collection Contents and Naming.....</b>	<b>6-1</b>
6.1	Data Set/Data Set Collection Contents .....	6-2
6.2	Data Set Naming and Identification.....	6-3
6.3	Data Set Collection Naming and Identification .....	6-4
6.4	Description of Name and ID Components.....	6-6
6.4.1	Format Restrictions on NAME- and ID-Class Elements.....	6-6
6.4.2	Standard Acronyms and Abbreviations .....	6-7
<b>Chapter 7.</b>	<b>Date/Time Format.....</b>	<b>7-1</b>
7.1	Date/Times .....	7-1
7.2	Dates .....	7-2
7.2.1	Conventional Dates.....	7-2
7.2.2	Native Dates.....	7-2
7.3	Times.....	7-2
7.3.1	Conventional Times.....	7-2
7.3.2	Native Times.....	7-3
<b>Chapter 8.</b>	<b>Directory Types and Naming.....</b>	<b>8-1</b>
8.1	Standard Directory Names.....	8-1
8.2	Formation of Directory Names .....	8-2
8.3	Path Formation Standard.....	8-4
8.4	Tape Volumes .....	8-4
8.5	Exceptions to These Standards .....	8-4
<b>Chapter 9.</b>	<b>Documents .....</b>	<b>9-1</b>
9.1	PDS Objects for Documents .....	9-2
9.1.1	TEXT Objects .....	9-2
9.1.2	DOCUMENT Objects.....	9-2
9.2	Document Format Details.....	9-4
9.2.1	Flat ASCII Text.....	9-4
9.2.2	ASCII Text Containing Markup Language.....	9-5
9.2.3	Non-ASCII Formats.....	9-6
9.2.4	Validation.....	9-6
9.3	Examples.....	9-6

9.3.1	Simple Attached label (Plain ASCII Text) .....	9-6
9.3.2	Complex Detached Label (Two Document Versions).....	9-6
9.3.3	Complex Detached Label (Documents Plus Graphics) .....	9-7
<b>Chapter 10.</b>	<b>File Specification and Naming.....</b>	<b>10-1</b>
10.1	File Specification Standards .....	10-1
10.1.1	ISO 9660 Level 1 Specification.....	10-2
10.1.2	ISO 9660 Level 2 Specification.....	10-2
10.2	Reserved Directory Names, File Names and Extensions.....	10-3
10.2.1	Reserved Directory Names .....	10-3
10.2.2	Reserved File Names .....	10-3
10.2.3	Reserved Extensions .....	10-3
10.3	Guidelines for Naming Sequential Files .....	10-5
<b>Chapter 11.</b>	<b>Media Formats for Data Submission and Archive .....</b>	<b>11-1</b>
11.1	CD-ROM Recommendations.....	11-1
11.1.1	Use of Variant Formats.....	11-1
11.1.2	Premastering Recommendation .....	11-2
11.2	DVD Recommendations .....	11-2
11.2.1	Use of Variant Formats.....	11-2
11.2.2	Premastering Recommendation .....	11-2
11.3	Packaging Software Files on a CD or DVD .....	11-2
11.4	Software Packaging Under Previous Versions of the Standard.....	11-2
<b>Chapter 12.</b>	<b>Object Description Language Specification and Usage.....</b>	<b>12-1</b>
12.1	About the ODL Specification .....	12-1
12.1.1	Implementing ODL.....	12-2
12.1.2	Notation.....	12-3
12.2	Character Set.....	12-3
12.3	Lexical Elements.....	12-6
12.3.1	Numbers.....	12-6
12.3.2	Dates and Times.....	12-8
12.3.3	Strings .....	12-10
12.3.4	Identifiers .....	12-11
12.3.5	Special Characters.....	12-12
12.4	Statements.....	12-12
12.4.1	Lines and Records.....	12-13
12.4.2	Attribute Assignment Statement .....	12-14
12.4.3	Pointer Statement .....	12-14
12.4.4	OBJECT Statement.....	12-15
12.4.5	GROUP Statement .....	12-16
12.5	Values .....	12-17
12.5.1	Numeric Values .....	12-18
12.5.2	Units Expressions.....	12-18
12.5.3	Text String Values .....	12-19
12.5.4	Symbolic Literal Values .....	12-20

12.5.5	Sequences.....	12-21
12.5.6	Sets.....	12-22
12.6	ODL Summary.....	12-22
12.7	Differences Between ODL Versions .....	12-24
12.7.1	Differences from ODL Version 1 .....	12-24
12.7.2	Differences from ODL Version 0 .....	12-25
12.7.3	ODL/PVL Usage.....	12-26
<b>Chapter 13.</b>	<b>PDS Objects / Groups.....</b>	<b>13-1</b>
13.1	Generic and Specific Data Object Definitions.....	13-1
13.1.1	Primitive Objects .....	13-2
13.2	Generic and Specific Data Group Definitions .....	13-3
13.2.1	Implementation of Group Statements .....	13-4
<b>Chapter 14.</b>	<b>Pointer Usage.....</b>	<b>14-1</b>
14.1	Types of Pointers .....	14-1
14.1.1	Data Location Pointers (Data Object Pointers).....	14-1
14.1.2	Include Pointers .....	14-1
14.1.3	Related Information Pointers (Description Pointers).....	14-2
14.2	Rules for Resolving Pointers .....	14-3
<b>Chapter 15.</b>	<b>Record Formats.....</b>	<b>15-1</b>
15.1	FIXED_LENGTH Records.....	15-1
15.2	STREAM Records .....	15-2
15.3	VARIABLE_LENGTH Records .....	15-2
15.4	UNDEFINED Records.....	15-3
<b>Chapter 16.</b>	<b>SFDU Usage.....</b>	<b>16-1</b>
16.1	The ZI SFDU Organization .....	16-2
16.2	The ZKI SFDU Organization.....	16-5
16.3	Examples.....	16-7
16.4	Exceptions to this Standard.....	16-8
<b>Chapter 17.</b>	<b>Usage of N/A, UNK and NULL.....</b>	<b>17-1</b>
17.1	Interpretation of N/A, UNK, and NULL .....	17-1
17.1.1	N/A.....	17-1
17.1.2	UNK.....	17-1
17.1.3	NULL.....	17-1
17.2	Implementation Recommendations for N/A, UNK, and NULL.....	17-3
<b>Chapter 18.</b>	<b>Units of Measurement.....</b>	<b>18-1</b>
18.1	SI Units .....	18-1
<b>Chapter 19.</b>	<b>Volume Organization and Naming.....</b>	<b>19-1</b>
19.1	Volume Set Types.....	19-1

19.2	Volume Organization Guidelines .....	19-7
19.3	Description of Directory Contents and Organization .....	19-7
19.3.1	ROOT Directory Files.....	19-8
19.3.2	Required Subdirectories.....	19-8
19.3.3	Optional Subdirectories .....	19-11
19.4	Volume Naming.....	19-18
19.4.1	Volume ID .....	19-18
19.5	Volume Set Naming.....	19-19
19.5.1	Volume Set ID .....	19-19
19.6	Logical Volume Naming.....	19-20
19.7	Exceptions to This Standard .....	19-20
<b>Chapter 20.</b>	<b>Zip Compression .....</b>	<b>20-1</b>
20.1	Zip Software.....	20-1
20.2	Zip File Labels .....	20-2
20.3	Packaging Zip Archives on Volumes .....	20-3
20.4	Label Example .....	20-3
20.5	ZIPINFO.TXT Example .....	20-4
20.6	Additional Files.....	20-5
<b>Appendix A.</b>	<b>PDS Data Object Definitions.....</b>	<b>A-1</b>
A.1	ALIAS.....	A-3
A.2	ARRAY (Primitive Data Object).....	A-4
A.3	BIT COLUMN.....	A-8
A.4	BIT ELEMENT (Primitive Data Object).....	A-11
A.5	CATALOG .....	A-12
A.6	COLLECTION (Primitive Data Object).....	A-15
A.7	COLUMN .....	A-16
A.8	CONTAINER .....	A-20
A.9	DATA PRODUCER.....	A-27
A.10	DATA SUPPLIER .....	A-29
A.11	DIRECTORY .....	A-31
A.12	DOCUMENT .....	A-33
A.13	ELEMENT (Primitive Data Object).....	A-36
A.14	FIELD .....	A-38
A.15	FILE .....	A-41
A.16	GAZETTEER_TABLE.....	A-45
A.17	HEADER .....	A-55
A.18	HISTOGRAM.....	A-57
A.19	HISTORY .....	A-60
A.20	IMAGE .....	A-64
A.21	INDEX_TABLE .....	A-69
A.22	PALETTE .....	A-74
A.23	QUBE.....	A-77
A.24	SERIES .....	A-85
A.25	SPECTRUM .....	A-90

A.26	SPICE KERNEL.....	A-93
A.27	SPREADSHEET.....	A-96
A.28	TABLE.....	A-101
A.29	TEXT.....	A-122
A.30	VOLUME.....	A-124
<b>Appendix B.</b>	<b>Complete PDS Catalog Object Set .....</b>	<b>B-1</b>
B.1	DATA_SET.....	B-4
B.2	DATA_SET_COLL_ASSOC_DATA_SETS.....	B-10
B.3	DATA_SET_COLL_REF_INFO.....	B-11
B.4	DATA_SET_COLLECTION.....	B-12
B.5	DATA_SET_COLLECTION_INFO.....	B-15
B.6	DATA_SET_HOST.....	B-17
B.7	DATA_SET_INFORMATION.....	B-18
B.8	DATA_SET_MAP_PROJECTION.....	B-21
B.9	DATA_SET_MAP_PROJECTION_INFO.....	B-23
B.10	DATA_SET_REFERENCE_INFORMATION.....	B-25
B.11	DATA_SET_TARGET.....	B-26
B.12	DS_MAP_PROJECTION_REF_INFO.....	B-27
B.13	IMAGE_MAP_PROJECTION.....	B-28
B.14	INSTRUMENT.....	B-33
B.15	INSTRUMENT_HOST.....	B-37
B.16	INSTRUMENT_HOST_INFORMATION.....	B-39
B.17	INSTRUMENT_HOST_REFERENCE_INFO.....	B-40
B.18	INSTRUMENT_INFORMATION.....	B-41
B.19	INSTRUMENT_REFERENCE_INFO.....	B-44
B.20	INVENTORY.....	B-45
B.21	INVENTORY_DATA_SET_INFO.....	B-47
B.22	INVENTORY_NODE_MEDIA_INFO.....	B-48
B.23	MISSION.....	B-49
B.24	MISSION_HOST.....	B-54
B.25	MISSION_INFORMATION.....	B-55
B.26	MISSION_REFERENCE_INFORMATION.....	B-57
B.27	MISSION_TARGET.....	B-58
B.28	PERSONNEL.....	B-59
B.29	PERSONNEL_ELECTRONIC_MAIL.....	B-61
B.30	PERSONNEL_INFORMATION.....	B-62
B.31	REFERENCE.....	B-63
B.32	SOFTWARE.....	B-70
B.33	SOFTWARE_INFORMATION.....	B-72
B.34	SOFTWARE_ONLINE.....	B-73
B.35	SOFTWARE_PURPOSE.....	B-74
B.36	TARGET.....	B-75
B.37	TARGET_INFORMATION.....	B-77
B.38	TARGET_REFERENCE_INFORMATION.....	B-78

<b>Appendix C. Internal Representation of Data Types.....</b>	<b>C-1</b>
C.1 MSB_INTEGER.....	C-1
C.2 MSB_UNSIGNED_INTEGER.....	C-2
C.3 LSB_INTEGER.....	C-3
C.4 LSB_UNSIGNED_INTEGER.....	C-5
C.5 IEEE_REAL.....	C-6
C.6 IEEE_COMPLEX.....	C-8
C.7 PC_REAL.....	C-9
C.8 PC_COMPLEX.....	C-11
C.9 VAX_REAL, VAXG_REAL.....	C-12
C.10 VAX_COMPLEX, VAXG_COMPLEX.....	C-15
C.11 MSB_BIT_STRING.....	C-15
C.12 LSB_BIT_STRING.....	C-16
<b>Appendix D. Examples of Required Files.....</b>	<b>D-1</b>
D.1 AAREADME.TXT.....	D-1
D.1.1 Annotated Outline.....	D-1
D.1.2 Example.....	D-2
D.2 INDXINFO.TXT.....	D-6
D.2.1 Example.....	D-6
D.3 SOFTINFO.TXT.....	D-7
D.3.1 Outline.....	D-7
D.3.2 Example.....	D-8
<b>Appendix E. NAIF TOOLKIT DIRECTORY STRUCTURE.....</b>	<b>E-1</b>
E.1 NAIF Directory.....	E-1
E.2 TOOLKIT Directory.....	E-1
E.3 Using the NAIF Toolkit.....	E-5
E.4 NAIF's File Naming Conventions.....	E-5
<b>Appendix F. Acronyms.....</b>	<b>F-1</b>
<b>Appendix G. SAVED Data.....</b>	<b>G-1</b>
<b>Appendix H. PDS Data Group Definitions.....</b>	<b>H-1</b>
H.1 PARAMETERS.....	H-3



## PDS Standards Reference Change Log

Version	Section	Change
3.1	1.1	PDS Data Policy added
	2.3	Reference coordinate standard expanded to support body-fixed rotating, body-fixed non-rotating, and inertial coordinate systems.
	2.4	Ring coordinate standard added.
	3.0	List of internal representations of data types moved to Appendix C
	3.2	EBCDIC_CHARACTER added to PDS Standard data types
	5.2.3	Minimal label option described
	6.3	Data set collection naming -- data processing level component made optional
	6.4	Data set naming -- added support for SPICE and Engineering, where no instrument component applies
	10.0, ALL	PDS use of UNIX/POSIX forward slash separator for path names. VMS-style bracket notation replaced.
	10.2.1	Required file names for catalog objects included
	12.5.4.2	PDS use of double quotes clarified
	13.2	Use of Primitive objects described
	14	New chapter -- Pointer Usage
	17	New chapter -- PDS Usage of N/A, UNK, and NULL
	19	Logical Volume organization added
	Appendix A	Primitive Objects added
	Appendix A	Header object -- required and optional keyword lists changed Container object -- Column no longer a required sub-object

Appendix B	Streamlined Catalog Object Templates with examples replace 3.0 set
Appendix C	New appendix containing internal representations of data types (moved from Chapter 3)
Appendix D	Outline and example for AAREADME.TXT added
Appendix E	Version 3.0 Acronyms and Abbreviations modified and moved to this Appendix. Spelling and Word Usage section deleted.
Index	The document now features an index.
ALL	No other substantive changes have been made to the standards since the release of Version 3.0. Throughout the document, clarifications have been made, typos corrected, some sections have been rearranged, and new examples have been supplied.

<b>Version</b>	<b>Section</b>	<b>Change</b>
3.2		Release Date: 7/24/95
	5.1.2	Label format discussion added Noted that values in labels should be upper case (except descriptions). Fixed examples in Appendix A.
	5.2.3, Appendix A	Noted that for data products using minimal labels, DATA_OBJECT_TYPE = FILE in the Data Set Catalog Template
	6	Added target IDs for DUST and SKY Added instrument component values SEDR and POS Noted that Data Set and Data Set Collection IDs and Names should be upper case. Fixed examples.
	8 and 19	Listed CALIB and GEOMETRY as recommended directory names (as opposed to required).
	8.2	SOFTWARE Subdirectory naming recommendation added
	9.1	Volumes may contain multiple versions of VOLINFO

- 9.2.1 Increased maximum line length in text file to 78 characters plus CR/LF
- 10.1 Clarified file name specification. Noted that file name must be upper case and that full stop character required
- 10.2 Added recommendation that file extension identify the data type of a file.  
Added .QUB as reserved file extension for spectral image qubes.  
Added SPICE file extensions to reserved file extension list.  
catalog pointer name and file name: SWINV.CAT  
Added LABINFO.TXT to list of required xxxINFO.TXT files.  
Added recommended xxx INFO.TXT file names for SOFTWARE subdirectories.
- 10.2.3 and 5.1 added note that detached label file (\*.LBL) should have the same base name as the associated data file
- 11.1.1 Added PDS Extended Attribute Record (XAR) policy
- 11.1.2 Added recommendation that CDs be premastered using single-session, single-track format.
- 11.1.3 Added section on Packaging Software files on a CD-ROM
- 14.1.2 Added new example of structure pointer
- 15 Added recommendation that for VAX/VMS-compatible CDs, fixed length and variable length files be an even number of bytes. Removed reference to VMS restriction to an even number of bytes in section 15.2
- 15.1 Removed discussion of use of BLOCK\_BYTES and BLOCKING\_TYPE (since this data element not in PSDD)
- 15.3 Added notation that CR/LF is required line terminator for PDS label and catalog files
- 15.5 Reworded first sentence.
- 17.2 Allow definition of numeric constants representing N/A, UNK, and NULL to be defined for use in an INDEX table.
- 18 replaced reference to PDS V1.0 with a general statement

19	Added SOFTWARE subdirectory recommendations
19	Recommend that an archive volume be based on a single version of the PDS standards. Volume organization guidelines added.
19.2	Clarified requirements for files & directories when logical volumes used
19.3	INDEX table standard update
19.3	use of axx- and bxx- prefixes in required file names clarified
19.4, Appendix A	fixed examples--Volume and Volume set names capitalized
19.5.1	Volume set ID formation rule modified.
Appendix A	updated COLUMN, BIT_COLUMN, and HISTOGRAM objects required and optional keyword lists to be consistent with Table 3.1
Appendix A	Added ALIAS and INDEX_TABLE objects
Appendix A	Added examples of COLUMN objects having ITEMS
Appendix A	Clarified use of ROW_SUFFIX_BYTES and ROW_PREFIX_BYTES for SPARE fields in Tables with fixed length records
Appendix A	Clarified the requirements for VOLUME objects for Logical volumes
Appendix A	Fixed examples using HEADER object to conform to current standard. Modified description of Header object to eliminate confusion..
Appendix B	Inventory, Software_Inventory and Target templates added
Appendix B	Removed incorrect example of use of Personnel template
Appendix D	INDXINFO.TXT and SOFTINFO.TXT outlines and examples added
Appendix D.1	Modified example of AAREADME.TXT to include rules on how pointer statements are resolved.

Appendix E and F	Added Appendix E - NAIF Toolkit Directory Structure. Acronyms and Abbreviations moved to Appendix F.
ALL	corrected typos, clarified text, added rationale for some standards, updated examples to conform to latest standards
Change Log	Version 3.1 change log updated--some items were missing

<b>Version</b>	<b>Section</b>	<b>Change</b>
3.3		Release Date: 6/1/99
	1.0	Added DVD as new medium
	1.3	Changed Version to 3.3
	1.6	Updated/corrected references
	1.7	Added reference to PDS web page
	2.0	Added definition for IAU Clarified text
	2.3	Corrected punctuation
	2.7	Fixed punctuation for references
	3.4	Corrected punctuation
	3.7	Corrected spelling and punctuation
	4.0	Added Section headers for Primary & Secondary Objects
	4.1	Corrected paragraph formatting
	5.1.2	Added paragraph about ASCII character set Added paragraph about Label Padding Fixed math in calculating start byte of 8th record Aligned keyword/values
	5.2.2	Corrected grammar
	5.2.3	Removed "" in the Data Set catalog template.
	5.3.1	Changed Version to 3.3
	5.3.2	Modified last paragraph
	5.3.3	Listed examples of primary and secondary objects
	5.3.3.2	Changed 'bottom' to 'following'
	5.3.4	Removed AMMOS as an example
	5.3.4.1	Removed SPACECRAFT_NAME as valid keyword
	5.3.4.3	Removed SPACECRAFT_NAME as valid keyword.
	5.3.5	Changed PDS has developed and continues to develop... Added example for a pointer (^DESCRIPTION)
	5.3.6	Aligned keyword/values Clarified statement
	5.3.7	Changed: needed for conformance
	6.0	Prioritized organizations that PDS works with
	6.1	Provided definition for Data Set Collection and removed MGN example.

	Corrected spelling (considerations) and punctuation
6.2	Added acronyms for data set name and identifier
6.3	Changed paragraph from future tense to past tense
6.4	Section 5 - comets
	Section 6 - added acronyms to list
	Section 6 - corrected spelling (ephemeris)
	Section 7 - corrected spelling (gravity)
	Section 8 - clarified version number rules
7.0	Updated paragraph
7.1	Clarified statements about date/time formats
7.2.1	Added PDS preference for convention
7.3.1	Corrected grammar
	Reformatted paragraph
7.3.2	Corrected grammar
	Updated paragraphs
8.1	Corrected grammar (standards directory)
	Added EXTRAS directory
	Added Browse and Data directory descriptions
8.2	Section 4 - Better examples of directory names
	Section 5 - Reformatted paragraph
	Section 8 - Corrected spelling and grammar
8.3	Changed to valid keywords
8.4	Corrected grammar (data are)
9.0 - 9.3.3	Complete rewrite of Documentation Standard
	Added HTML standards
10.0 - 10.1	Added ISO 9660 Level 2 description
	Added ";1" to Level 1 description
10.2.1	Clarified required file names paragraphs
	Added TARGET_CATALOG pointer to list
10.2.2	VOLDESC.SFD file becomes deprecated
10.2.3	Described detached label
	Corrected grammar (its)
10.2.4	Added extensions and changed SPICE extensions
	Corrected spelling (postscript) and grammar (data that have)
11.1.1	Changed chapter name
12.1	Aligned equal signs
12.1.1.1	Added reference
12.2	Reformatted paragraph
12.3	Spelling
12.3.1	Corrected punctuation (1.234E2)
12.3.1.2	Corrected value (16#+4B#)
	Reformatted paragraph
12.3.1.3	Corrected value (1.234E3)
12.3.2	Updated paragraphs
12.3.2.1	Clarified date format
12.3.2.3	Clarified paragraph

12.3.2.4	Changed year to 4 digits
12.3.2.5	Updated paragraph
12.3.2.5.1	Corrected value (1990-158T15:24:12z)
12.3.3.1	Corrected value ("::=")
12.3.4	Added examples
12.3.5	Corrected punctuation and grammar (units)
12.4	Corrected punctuation
12.4.1	Corrected grammar (the the) Aligned equal signs
12.4.2	Aligned equal signs
12.5.2	Reformatted asterisks to not be superscript Corrected value (60.15)
12.5.3.1	Corrected grammar (affect) Reformatted paragraphs
12.5.4	Corrected value (IO) Added valid quoted strings
12.5.4.1	Clarified paragraph
12.5.5	Reformatted asterisk to not be superscript Corrected spelling (eccentricity) Changed to valid keyword
12.5.6	Corrected value (removed 1st bracket "[") Changed to valid keyword
12.6	Reformatted paragraphs
12.7	Reformatted paragraphs
12.7.1	Corrected grammar (sections detail)
12.7.2	Corrected grammar ("is that are")
13.1	Added required keywords to definition
14.1.1	Corrected grammar (occurs)
14.1.2	Corrected punctuation Corrected value (^STRUCTURE) Changed paragraph numbering
14.2	Reformatted pointer rules
15.0	Reformatted paragraph and table
15.2	Changed paragraph numbering
15.3	Changed paragraph numbering
16.0	Corrected grammar
16.2	Clarified paragraph Changed case of #mark#
17.1	Changed case of title (and)
17.1.2	Corrected punctuation (information)
17.2	Corrected case of title (and)
18.0	Corrected SI Units (electricity potential, etc) Updated paragraph
19.1	Corrected grammar (volume types) Corrected grammar (up to the)
19.3	Corrected grammar (an SFDU)

	Corrected spelling (global)
	Updated Catalog and Index definitions
	Added description of the EXTRAS directory
	Added Preferred Method for supplying PDS catalog objects
19.4.1	Corrected grammar (data have been)
	Changed case of value (ID)
19.5	Corrected spelling (radiometry)
	Corrected value (VOLUME_SET_NAME)
	Corrected value (VOLUME_SET_ID)
19.5.1	Reformatted paragraph
19.7	Corrected case of value (IDs)
20.0 - 20.6	Complete rewrite of Zip Compression
Appendix A	Added URL to Cold Fusion pages
A.1	Updated definition for ALIAS
	Corrected spelling (subobject)
A.2	Added and changed Optional keywords
	Reformatted paragraphs
	Corrected spelling (the time)
A.3	Changed Optional keywords
	Corrected spelling (created)
A.5	Added TARGET to Optional Objects
	Clarified use of CATALOG.CAT
	Formatted paragraph
A.7	Formatted paragraph
	Changed Optional keywords
A.8	Updated paragraph
A.10	Changed case of keyword values to uppercase
A.11	Corrected grammar (on a)
	Corrected grammar (on the medium)
A.12	Removed incorrect statements
	Updated example
A.13	Changed Optional keywords
A.14	Removed a Required keyword
	Added Optional keywords
A.15	Changed value to keyword (GAZETTEER_TABLE)
	Corrected grammar (the breath & upper right)
	Added Optional Keywords section
	Added Optional Objects section
	Added trailing double quote to DESCRIPTION section
A.16	Corrected paragraph to reflect proper file name
	Changed value to be enclosed in double quotes
A.18	Added Required and Optional Keywords and Objects sections
A.19	Added BAND_NAME keyword
	Added Optional keyword
	Changed values to be keyword (CHECKSUM)
	Changed values to be keyword (SCALING_FACTOR)



A.20	Changed paragraphs Changed case of keyword values to uppercase
A.21	Reformatted paragraphs Removed Optional Keyword Added Optional Objects Corrected example (see additional example in A.27.1)
A.23	Added example for CORE_ITEM_TYPE Corrected FILE_RECORDS to be accurate Corrected invalid keyword (SUB_SOLAR_AZIMUTH)
A.24	Corrected grammar (data that vary)
A.26	Corrected grammar (data are)
A.27	Corrected punctuation (The Toolkit) Corrected grammar (meta-data which are) Updated section numbers to reflect location (spares) Repaired examples (byte lengths)
A.28	Line length to 72 chars Added Required and Optional Objects Repaired example
A.29	Updated Optional keyword Changed case of keyword values to uppercase
Appendix B	Changed paragraph Changed text description length to be 80 characters from 72 Added text formatting standards
B.1	Corrected punctuation Repaired example
B.2	Reformatted paragraph Reformatted and repaired example
B.3	Corrected spelling (DESCRIPTION) Reformatted paragraph Reformatted and repaired example
B.4	Corrected spelling (description & instrument) Reformatted paragraph Reformatted and repaired example
B.5	Corrected grammar (properties of the) Reformatted paragraph Reformatted and repaired example
B.6	Repaired example
B.7	Reformatted paragraph Reformatted and repaired example
B.8	Repaired example
B.10	Corrected spelling (package) Replaced example of SOFTWARE_INVENTORY template
B.11	Corrected grammar (target catalog) Corrected grammar (SURFACE_GRAVITY) Repaired example
Appendix C	Minor corrections throughout text

C.5	Corrected spelling (exponent-as-stored)
C.10	Corrected spelling (imaginary)
Appendix E	Corrected sentence (source code for) Corrected spelling (spacit) Corrected grammar (These data are) Corrected punctuation
Appendix F	Corrected CD-WO nomenclature Added DE (Data Engineer) Corrected spelling (Principal)
Appendix G	Added SAVED Data as new section

<b>Version</b>	<b>Section</b>	<b>Change</b>
----------------	----------------	---------------

3.4		Release Date: 06/15/2001
-----	--	--------------------------

Technical editing of the entire document (Chapters 1-20, Appendices A-G) was performed by Anne Raugh under contract to JPL. This editing focused on correcting awkward language, making examples consistent with the text, clarifying apparent internal inconsistencies, and in general ensuring a more readable document. Substantive changes to the standards themselves were specifically prohibited. Document changes made by Raugh were reviewed by Lyle Huber (ATMOS) and Ron Joyner (CN). Cases in which the intention of the original document could not be determined by the above team were referred to Steve Hughes (CN), who acted as both historian and final arbiter.

On May 04, 2001, Ann Raugh, Richard Simpson, Lyle Huber, Steve Hughes, and Ron Joyner met at New Mexico State University to discuss and arbitrate the final set of changes to be incorporated into this document.

<b>Version</b>	<b>Section</b>	<b>Change</b>
----------------	----------------	---------------

3.5		Release Date: 02/15/2002
-----	--	--------------------------

	19.4.1	Changed length of VOLUME_ID from 9 chars to 11 chars
--	--------	--

	19.5.1	Changed formation rule for VOLUME_SET_ID
--	--------	--

Appendix B.31 – Reference. Amended Reference section to include more definitive language on what is appropriate to cite, what is not, and how to cite each type of reference.

<b>Version</b>	<b>Section</b>	<b>Change</b>
----------------	----------------	---------------

3.6		Release Date: 08/01/2003
-----	--	--------------------------

	3.1	Modified to include FIELD data element
--	-----	--

	3.2	Modified to include FIELD data element
--	-----	--

	3.8	Modified to include SPREADSHEET object
--	-----	--

	4.0	Modified to include SPREADSHEET as primary object
--	-----	---

	5.5	Added definition for Locally Defined Data Elements
--	-----	--

5.5.1	Added Justification for Locally Defined Data Elements
5.5.2	Added Identification for Locally Defined Data Elements
5.5.3	Added Review and Use of Locally Defined Data Elements
7.3.1	Modified 1 <sup>st</sup> two paragraphs to clarify GMT/UTC relationship
7.4(6)	Added Note for Greenwich time
10.2.3	Modified list to include CSV as reserved file extension
12.2.3	Modified use of Colon in assignment statements (namespace)
12.4.2	Modified to include namespace_identifier:element_identifier
12.6	Modified to include namespace_identifier:element_identifier
19.3.3.2	Modified to include Optional use of Data Dictionary Files
A.2.5	Removed 'Z' from time value
A.13.2.1	Added Note for PARMS as alias to PARAMETERS group
A.14	Added FIELD object (sub-object of SPREADSHEET)
A.15 thru A.26	Renumbered sections (the old A.14 became A.15, etc)
A.15.5	Removed 'Z' from time value
A.17.5	Removed 'Z' from time value
A.25	Modified UTC / GMT for LEAPSECONDS
A.27	Added SPREADSHEET object
A.23.4	Removed 'Z' from time value
A.24.5	Removed 'Z' from time value
A.25.5	Removed 'Z' from time value
A.26.5	Removed 'Z' from time value
A.28 thru A.30	Renumbered sections (the old A.27 became A.28, etc)
A.28.4.1	Removed 'Z' from time value
A.28.5.1.3	Removed 'Z' from time value
B.1.6	Modified to include CITATION_DESC data element
B.7.1	Modified to include CITATION_DESC data element
B.7.5.3	Modified to include CITATION_DESC formation rule
B.7.5.4	Renumbered from B.7.5.3

# Chapter 1. Introduction

In order for planetary science data to be useful to those not directly involved in its creation, supporting information must be made available with the data to allow effective use and interpretation. The exchange of data is increasingly important in planetary science; thus there is a need for establishment and enforcement of standards regarding the quality and completeness of data. Electronic communication has become more sophisticated, and the use of new media (such as CD-ROMs and DVD) for data storage and transfer requires additional formatting standards to ensure long-term readability and usability. To these ends, the Planetary Data System (PDS) has developed a data set nomenclature consistent across discipline boundaries, as well as standards for labeling data files.

## 1.1 PDS Data Policy

Only data that comply with PDS standards will be published in volumes labeled “Conforms to PDS Standards”. When the PDS assists in the preparation of data published in a non-compliant format, PDS participation should be acknowledged with the statement such as “funded by PDS”. The PDS Management Council makes decisions on compliance waivers. Non-compliant data sets will be incorporated into the PDS archives only under unusual circumstances.

## 1.2 Purpose

This document is intended as a reference manual for use in conjunction with the *PDS Data Preparation Workbook* and the *Planetary Science Data Dictionary*. The *PDS Data Preparation Workbook* describes the end-to-end process for submitting data to the PDS and gives instructions for preparing data sets. In addition, a glossary of terms used throughout the documentation is included as an appendix to the Workbook. The Planetary Science Data Dictionary (PSDD) contains definitions of the standard data element names and objects. This Standards Reference defines all PDS standards for data preparation.

## 1.3 Scope

The information included here constitutes Version 3.4 of the Planetary Data System data preparation standards for producing archive quality data sets.

## 1.4 Audience

This document is intended primarily to serve the community of scientists and engineers responsible for preparing planetary science data sets for submission to the PDS. These include restored data from the era prior to PDS, mission data from active and future planetary missions, and data from earth-based sites. The audience includes personnel at PDS discipline and data nodes, mission principal investigators, and ground data system engineers.

## 1.5 Document Organization

The first chapter of this document, “Chapter 1 – Introduction”, provides introductory material and citations of other reference documents. The remaining chapters provide an encyclopedia of data preparation standards, organized alphabetically by standard title.

## 1.6 Other Reference Documents

The following references are cited in this document:

- ?? Batson, R. M., (1987) “Digital Cartography of the Planets: its Status and Future”, *Photogrammetric Engineering & Remote Sensing* 53, 1211-1218.
- ?? Davies, M.E., *et al.* (1991) “Report of the IAU/IAG/COSPAR Working Group on Cartographic Coordinates and Rotational Elements of the Planets and Satellites: 1991”, *Celestial Mechanics*, 53,377-397.
- ?? Greeley, R. and Batson, R.M. (1990) *Planetary Mapping*, Cambridge University Press, Cambridge, 296p.
- ?? *Guide on Data Entity Naming Conventions*, NBS Special Publication 500-149.
- ?? *Planetary Science Data Dictionary*, JPL D-7116 Rev D, July 15, 1996, (Available from the PDS).
- ?? *Planetary Data System Data Preparation Workbook Version 3.1*, JPL D-7669 Part 1, February 17, 1995, (Available from the PDS)
- ?? *Issues and Recommendations Associated with Distributed Computation and Data Management Systems for the Space Sciences*, National Academy Press, Washington, DC, 111p.

?? ISO 646:1991 ASCII character set.

?? ISO 8601:1988 “Data Element and Interchange Formats – Representations of Dates and Times”

SFDU and PVL References:

?? *Standard Formatted Data Units - Structure and Construction Rules*, CCSDS 620.0-R-1.1c, May 1992.

?? *Standard Formatted Data Units - A Tutorial*; CCSDS 620.0-G-1, May 1992.

?? *Parameter Value Language Specification (ccsd0006)*; CCSD 641.0-R-0.2, June 1991.

?? *Parameter Value Language -- A Tutorial*; CCSDS 641.0-G-1.0, May 1992.

## 1.7 Online Document Availability

The *Planetary Science Data Dictionary*, *Planetary Data System Data Preparation Workbook*, and this document, the *Planetary Data System Standards Reference*, are available online. Information on accessing these references may be found on the PDS website at the following URL:

<http://pds.jpl.nasa.gov>

To obtain a copy of these documents or for questions concerning these documents, contact the PDS Operator (at PDS\_OPERATOR@jpl.nasa.gov, 626-744-5579) or a PDS data engineer.

The examples provided throughout the chapters and appendices are based on both existing and planned PDS archive products, modified to reflect the current version of the PDS Standards. Data object definitions are refined and augmented from time to time, as user community needs arise, so object definitions from products designed under older versions of the Standards may differ significantly. To check the current state of any object definition, consult a PDS data engineer or this URL:

<http://pdsproto.jpl.nasa.gov/ddcolstdval/newdd/top.cfm>

Additional examples may be obtained by contacting a Data Engineer.

Compliance waivers , 1-1

, 1-1

*Data Preparation Workbook, 1-1*

data set

Non-compliant, 1-1

Management Council , 1-1

object definitions, 1-3

*Planetary Science Data Dictionary, 1-1*

, 1-2

, 1-2

, 1-3

, 1-2

, 1-3

, 1-3

, 1-1

Waivers (compliance) , 1-1

# Chapter 2. Cartographic Standards

The following cartographic data standards were developed through an iterative process involving both the NASA Planetary Cartography Working Group (PCWG) and the PDS. Members of the PCWG also serve on the key International Astronomical Union (IAU) committee that formulates these standards for international adoption. It is the intention of the PDS to keep its own cartographic standards in line with those of the PCWG, and in turn the IAU.

The cartographic standards used in any particular data set should be identified and, where helpful, documented on the archive volume.

## 2.1 Inertial Reference Frame, Time Tags and Units

The Earth Mean Equator and Equinox of Julian Date 2451545.0 (referred to as the J2000 system) is the standard inertial reference frame. The Earth Mean Equator and Equinox of Besselian 1950 (JD 2433282.5) is also supported because of the wealth of previous mission data referenced to this system. (The transformation between the two systems is well defined.)

The standard format for time tags is UTC in year, month, day, hour, minute and decimal seconds, although Julian dates are also supported.

The standard units are SI metric units, including decimal degrees.

## 2.2 Spin Axes and Prime Meridians

The IAU-defined spin axes and prime meridians defined relative to the J2000 inertial reference system are the standard for planets, satellites and asteroids where these parameters are defined. For other planetary bodies, definitions of spin axis and prime meridian determined in the future should have the body-fixed axis aligned with the principal moment of inertia, with the North Pole defined as lying along the spin axis and above the Invariable Plane. Where insufficient observations exist for a particular body to determine the principal moment of inertia, coordinates of a surface feature will be specified and these used to define the prime meridian. Note that some small, irregular bodies may have chaotic rotations and will thus need to be handled on a case-by-case basis.

## 2.3 Reference Coordinates

There are three basic types of coordinate systems: body-fixed rotating; body-fixed non-rotating; and inertial. A body-fixed coordinate system is one associated with the body (e.g., a planet or satellite). The body-fixed system is centered on the body and rotates with the body (unless it is a non-rotating type), whereas an inertial coordinate system is fixed at some point in space.

To support the descriptions of these various reference coordinate systems, the PDS has defined the following set of data elements (See the *Planetary Science Data Dictionary* for complete definitions.):



COORDINATE\_SYSTEM\_TYPE  
 COORDINATE\_SYSTEM\_NAME  
 LATITUDE  
 LONGITUDE  
 EASTERNMOST\_LONGITUDE  
 WESTERNMOST\_LONGITUDE  
 MINIMUM\_LATITUDE  
 MAXIMUM\_LATITUDE  
 POSITIVE\_LONGITUDE\_DIRECTION

Currently, the PDS has specifically defined two types of body-fixed rotating coordinate systems: planetocentric and planetographic. However, the set of related data elements are modeled such that definitions for other body-fixed rotating coordinate systems, body-fixed non-rotating and inertial coordinate systems can be added as the need arises. Contact a PDS data engineer for assistance in defining a specific coordinate system.

The definition of planetographic longitude is dependent upon the rotation direction of the body, with longitude defined as increasing in the direction opposite to the rotation. That is to say, the longitude increases to the west if the rotation is prograde (or eastward) and vice versa. Table 2.1 lists the rotation direction (prograde or retrograde) of the primary planetary bodies and the Earth's Moon. It also indicates the valid longitude range for each body. In order to accommodate different traditions in measuring longitude, the *Planetary Science Data Dictionary* defines a broad longitude range: (-180, 360). Table 2.1 indicates which part of that range is applicable to which body.

**Table 2.1: Primary Bodies and Earth's Moon: Rotation Direction and Longitude Range**

<b>Planet</b>	<b>Rotation Direction</b>	<b>Longitude Range</b>
Earth	Prograde	(0, 360) (-180, 180)*
Mars	Prograde	(0, 360)
Mercury	Prograde	(0, 360)
Moon	Prograde	(0, 360) (-180, 180)*
Jupiter	Prograde	(0, 360)
Neptune	Prograde	(0, 360)
Pluto	Retrograde	(0, 360)
Saturn	Prograde	(0, 360)
Sun	Prograde	(0, 360) (-180, 180)*
Uranus	Retrograde	(0, 360)
Venus	Retrograde	(0, 360)

\* The rotations of the Earth, Moon and Sun are prograde, however it has been traditional to measure longitudes for these bodies as increasing to the east instead of the west. The PDS recommends that the planetographic longitude standard be followed, but also supports the

traditional method. Specifically, the longitude range of ( -180, 180) is supported for the Earth, Moon and Sun

## 2.3.1 Body-Fixed Rotating Coordinate Systems

### 2.3.1.1 Planetocentric

The planetocentric system has an origin at the center of mass of the body. Planetocentric latitude is the angle between the equatorial plane and a vector connecting the point of interest and the origin of the coordinate system. Latitudes are defined as positive in the northern hemisphere of the body, where north is in the direction of Earth's angular momentum vector, i.e., pointing toward the hemisphere north of the solar system invariant plane. Longitudes increase toward the east, making the planetocentric system right-handed.

### 2.3.1.2 Planetographic

The planetographic system has an origin at the center of mass of the body. The planetographic latitude is the angle between the equatorial plane and a vector through the point of interest, where the vector is normal to a biaxial ellipsoid reference surface. Planetographic longitude is defined as increasing with time to an observer fixed in space above the object of interest. Thus, for prograde rotators (rotating counter clockwise as seen from a fixed observer located in the hemisphere to the north of the solar system invariant plane), planetographic longitude increases toward the west. For a retrograde rotator, planetographic longitude increases toward the east.

## 2.4 Rings

Locations in planetary ring systems are specified in polar coordinates by a radius distance (measured from the center of the planet) and a longitude. Longitudes increase in the direction of orbital motion, so the ring pole points in the direction of right-handed rotation. Note that this corresponds to the IAU-defined North Pole for Jupiter, Saturn and Neptune, but the South Pole for Uranus.

Longitudes are given relative to the ascending node of the ring plane on the Earth's mean equator of J2000. However, the Earth's mean equator of B1950 is also supported as a reference longitude because of the wealth of data already reduced using this coordinate frame. The difference is generally a small, constant offset to the longitude. All longitude values fall between 0 and 360 degrees.

Note that ring coordinates are always given in an inertial frame, as it is impossible to define a suitable rotating coordinate frame for a ring system where features rotate at different rates. When it is necessary to specify the location of a moving body or feature, the rotation rate and epoch must be specified in addition to the longitude.

To support the description of locations in a planetary ring system, the PDS has defined the following elements :

RING\_RADIUS  
 MINIMUM\_RING\_RADIUS  
 MAXIMUM\_RING\_RADIUS

RING\_LONGITUDE  
 MINIMUM\_RING\_LONGITUDE  
 MAXIMUM\_RING\_LONGITUDE

B1950\_RING\_LONGITUDE  
 MINIMUM\_B1950\_RING\_LONGITUDE  
 MAXIMUM\_B1950\_RING\_LONGITUDE

RING\_EVENT\_TIME  
 RING\_EVENT\_START\_TIME  
 RING\_EVENT\_STOP\_TIME

RADIAL\_RESOLUTION  
 MINIMUM\_RADIAL\_RESOLUTION  
 MAXIMUM\_RADIAL\_RESOLUTION

The radius and longitude elements define an inertial location in the rings, and the ring event time elements define the time at the ring plane to which an observation refers. If desired, the radial resolution elements can be used to specify the radial dimensions of ring features that can be resolved in the data. See the *Planetary Science Data Dictionary* (PSDD) for complete definitions of these elements.

In general, the above elements refer to locations in an equatorial ring. However, under certain circumstances it is necessary to define these values for an inclined ring, in which case the interpretations are slightly more complicated. Here longitudes are measured as a “broken angle” along the planet’s equatorial plane to the ascending node of the ring plane, and thence along the ring plane. In these circumstances, it is also necessary to define the orbital elements of the ring in question via the following elements in the PSDD:

RING\_INCLINATION  
 RING\_ASCENDING\_NODE\_LONGITUDE  
 NODAL\_REGRESSION\_RATE  
 POLE\_RIGHT\_ASCENSION  
 POLE\_DECLINATION  
 COORDINATE\_SYSTEM\_ID

The ascending node longitude refers to the moment defined by the RING\_EVENT\_TIME. The ring inclination is given relative to the planet’s equator, as specified by the spin pole’s right ascension and declination. The COORDINATE\_SYSTEM\_ID can be either “J2000” or “B1950”, with “J2000” serving as the default. See the PSDD for further details.

## 2.5 Reference Surface

Two standard reference surface models are supported: the digital terrain model (DTM) and the digital image model (DIM). Note, however, that Mars is an exception for which planetographic latitude is used.

The digital terrain model defines body radius as a function of cartographic latitude and longitude in a sinusoidal equal-area projection. Spheroids, ellipsoids and harmonic expansions giving analytic expressions for radius as a function of cartographic coordinates are all supported.

The digital image model (DIM) defines body brightness in a specified spectral band or bands as a function of cartographic latitude and longitude in a sinusoidal equal-area projection, and associated with the surface radius values in the corresponding DTM. DIMs registered to spheroids, ellipsoids and harmonic expansions are supported.

## 2.6 Map Resolution

The suggested spatial resolution for a map is  $1/2^{m,n}$  degrees. The suggested vertical resolution is  $1 \times 10^m$  meters, with  $m$  and  $n$  chosen to preserve all the resolution inherent in the data.

## 2.7 References

The following references provide more detail on the cartographic data standards:

Davies, M. E., et al (1991) "Report of the IAU/IAG/COSPAR Working Group on Cartographic Coordinates and Rotational Elements of the Planets and Satellites: 1991," *Celestial Mechanics*, 53, 377-397.

Batson, R.M., (1987) "Digital Cartography of the Planets: New Methods, its Status and Future", *Photogrammetric Engineering & Remote Sensing*, 53, 1211-1218.

Greeley, R. and Batson, R.M. (1990) *Planetary Mapping*, Cambridge University Press, Cambridge, 296p.

- body coordinates
  - prime meridians , 2-1
  - spin axes, 2-1
- map resolution, 2-5
- reference coordinates, 2-1
  - body-fixed, 2-2, 2-3
  - data elements, 2-2
  - planetocentric, 2-2, 2-3
  - planetographic, 2-2, 2-3
  - ring systems, 2-3
  - ring systems, data elements, 2 -4
- reference frames
  - B1950, 2-1
  - standard inertial (J2000), 2 -1
- reference surface models, 2-5
  - digital image model (DIM), 2 -5
  - digital terrain model (DTM), 2 -5
- rotation direction
  - of Solar System bodies, 2-2
- time tags
  - format, 2-1

# Chapter 3. DATA\_TYPE Values and Data File Storage Formats

Each PDS archived product is described using label objects that provide information about the data types of stored values. The data elements DATA\_TYPE, BIT\_DATA\_TYPE, and SAMPLE\_TYPE appear together with related elements defining starting location and length for each field. In PDS data object definitions the byte, bit, and record positions are counted from left to right, or first to last encountered, and always begin with 1.

Data files may be in ASCII or binary format. ASCII format is often more easily transferred between hardware systems or even application programs on the same computer. Notwithstanding, numeric data are often stored in binary files when the ASCII representation would require substantially more storage space. (For example, each 8-bit signed pixel value in a binary image file would require a four-byte field if stored as an ASCII table.)

## 3.1 Data Elements

Table 3.1 identifies by object the data elements providing type, location, and length information. The elements ITEMS and ITEM\_BYTES are used to subdivide a single COLUMN, FIELD, BIT\_COLUMN, or HISTOGRAM into a regular vector containing as many elements as specified for the value of ITEMS. In these objects the DATA\_TYPE must indicate the type of a single item in the vector. In the past, the data element ITEM\_TYPE was used for this purpose, but DATA\_TYPE is now the preferred parameter.

## 3.2 Data Types

Table 3.2 identifies the valid values for the DATA\_TYPE, BIT\_DATA\_TYPE, and SAMPLE\_TYPE data elements used in PDS data object definitions. The values for these elements must be one of the standard values listed in the *Planetary Science Data Dictionary* (PSDD). Please note:

- In all cases, these standard values refer to the physical storage format of the data in the data file.
- In some cases, obsolete values from previous versions of the PDS Standards have been retained as aliases for more specific values (the type “INTEGER”, for example, is interpreted as “MSB\_INTEGER” when it is encountered). In these cases the more specific value should always be used in new data sets – the obsolete value is retained only for backward compatibility. Obsolete values are indicated in the table.
- Aliases have been supplied for some of the generic data types that indicate the kind of system on which the data originated. For example, “MAC\_REAL” is an alias for “IEEE\_REAL”, but “VAX\_REAL” has no alias, as the VAX binary storage format is unique to VAX systems. In general, the more generic term is preferred, but the system-specific version may be used if needed.

**Table 3.1: Type Elements Used in Data Label Objects**

<b>Data Object</b>	<b>Data Elements</b>	<b>Notes</b>
COLUMN (without ITEMS)	DATA_TYPE START_BYTE BYTES	
COLUMN (with ITEMS)	DATA_TYPE START_BYTE BYTES ( <i>optional</i> ) ITEMS ITEM_BYTES	alias for ITEM_TYPE  total bytes in COLUMN  bytes in each ITEM
BIT_COLUMN (without ITEMS)	BIT_DATA_TYPE START_BIT BITS	
BIT_COLUMN (with ITEMS)	START_BIT BITS ( <i>optional</i> ) ITEMS ITEM_BITS	total bits in BIT_COLUMN  bits in each ITEM
FIELD (no items)	DATA_TYPE FIELD_NUMBER BYTES	if populated  maximum FIELD bytes
FIELD (with items)	DATA_TYPE FIELD_NUMBER BYTES ITEMS ITEM_BYTES	if populated  maximum bytes in FIELD  maximum item bytes
IMAGE	SAMPLE_TYPE SAMPLE_BITS	
HISTOGRAM	DATA_TYPE BYTES ( <i>optional</i> ) ITEMS ITEM_BYTES	alias for ITEM_TYPE  total bytes in HISTOGRAM  number of bins in HISTOGRAM  bytes in each ITEM

**Table 3.2: Standard PDS Data Types****Data Element Usage Codes:**

D = DATA\_TYPE  
 B = BIT\_DATA\_TYPE  
 S = SAMPLE\_TYPE

Usage	Value	Description
D	ASCII_REAL	ASCII character string representing a real number; see Section 5.4 for formatting rules
D	ASCII_INTEGER	ASCII character string representing an integer; see Section 5.4 for formatting rules
D	ASCII_COMPLEX	ASCII character string representing a complex number; see Section 5.4 for formatting rules
<i>Obsolete</i>	BIT_STRING	alias for MSB_BIT_STRING
D, B	BOOLEAN	True/False Indicator: a 1-, 2- or 4-byte integer or 1-32 bit number. All 0 = False; anything else = True.
D	CHARACTER	ASCII character string; see Section 5.4 for formatting rules
<i>Obsolete</i>	COMPLEX	alias for IEEE_COMPLEX
D	DATE	ASCII character string representing a date in PDS standard format; see Section 5.4 for formatting rules
D	EBCDIC_CHARACTER	EBCDIC character string
<i>Obsolete</i>	FLOAT	alias for IEEE_REAL
D	IBM_COMPLEX	IBM 360/370 mainframe complex number (8- or 16-byte)
D, S	IBM_INTEGER	IBM 360/370 mainframe 1-, 2-, and 4-byte signed integers
D, S	IBM_REAL	IBM 360/370 mainframe real number (4- or 8-byte)
D, B, S	IBM_UNSIGNED_INTEGER	IBM 360/370 mainframe 1-, 2-, and 4-byte unsigned integers
D	IEEE_COMPLEX	8-, 16-, and 20-byte complex numbers
D, S	IEEE_REAL	4-, 8- and 10-byte real numbers
<i>Obsolete</i>	INTEGER	alias for MSB_INTEGER
D	LSB_BIT_STRING	1-, 2-, and 4-byte bit strings
D, S	LSB_INTEGER	1-, 2-, and 4-byte signed integers
D, B, S	LSB_UNSIGNED_INTEGER	1-, 2-, and 4-byte unsigned integers
D	MAC_COMPLEX	alias for IEEE_COMPLEX
D, S	MAC_INTEGER	alias for MSB_INTEGER
D, S	MAC_REAL	alias for IEEE_REAL
D, B, S	MAC_UNSIGNED_INTEGER	alias for MSB_UNSIGNED_INTEGER
D	MSB_BIT_STRING	1-, 2-, and 4-byte bit strings
D, S	MSB_INTEGER	1-, 2-, and 4-byte signed integers
D, B, S	MSB_UNSIGNED_INTEGER	1-, 2-, and 4-byte unsigned integers
D, B	N/A	Used only for spare (or unused) fields included in the data file.



D	PC_COMPLEX	8-, 16-, and 20-byte complex numbers in IBM/PC format
D, S	PC_INTEGER	alias for LSB_INTEGER
D, S	PC_REAL	4-, 8-, and 10-byte real numbers in IBM/PC format
D, B, S	PC_UNSIGNED_INTEGER	alias for LSB_UNSIGNED_INTEGER
<i>Obsolete</i>	REAL	alias for IEEE_REAL
D	SUN_COMPLEX	alias for IEEE_COMPLEX
D, S	SUN_INTEGER	alias for MSB_INTEGER
D, S	SUN_REAL	alias for IEEE_REAL
D, B, S	SUN_UNSIGNED_INTEGER	alias for MSB_UNSIGNED_INTEGER
D	TIME	ASCII character string representing a date/time in PDS standard format; see Section 5.4 for formatting rules
<i>Obsolete</i>	UNSIGNED_INTEGER	alias for MSB_UNSIGNED_INTEGER
D	VAX_BIT_STRING	alias for LSB_BIT_STRING
D	VAX_COMPLEX	Vax F-, D-, and H-type (8-, 16- and 32-byte, respectively) complex numbers
D, S	VAX_DOUBLE	alias for VAX_REAL
D, S	VAX_INTEGER	alias for LSB_INTEGER
D, S	VAX_REAL	Vax F-, D-, and H-type (4-, 8- and 16-byte, respectively) real numbers
D, B, S	VAX_UNSIGNED_INTEGER	alias for LSB_UNSIGNED_INTEGER
D	VAXG_COMPLEX	Vax G-type (16-byte) complex numbers
D, S	VAXG_REAL	Vax G-type (8-byte) real numbers

### 3.3 Binary Integers

There are two widely used formats for integer representations in 16-bit and 32-bit binary fields: most significant byte first (MSB) and least significant byte first (LSB) architectures. The MSB architectures include IBM mainframes, many UNIX systems such as SUN, and Macintosh computers. The LSB architectures include VAX systems and IBM PCs. In the original PDS system the default format was MSB, thus the designation of “INTEGER” and “UNSIGNED\_INTEGER” as aliases of “MSB\_INTEGER” and “MSB\_UNSIGNED\_INTEGER”. New data sets should be prepared using the appropriate specific designation from Table 3.2, above.

### 3.4 Signed vs. Unsigned Integers

The “\_INTEGER” data types refer to signed, 2’s complement integers. Use the corresponding “\_UNSIGNED\_INTEGER” type for unsigned integer and bit string fields.

### 3.5 Floating Point Formats

The PDS default representation for floating point numbers is the ANSI/IEEE standard. This representation is defined as the IEEE\_REAL data type, with aliases identified in Table 3.2. Several additional specific floating-point representations supported by PDS are described in Appendix C.

### 3.6 Bit String Data

The BIT\_STRING data types are used in definitions of table columns holding individual bit field values. A BIT\_COLUMN object defines each bit field. BIT\_STRING data types can be 1-, 2-, or 4-byte fields, much like a binary integer. Extraction of specific bit fields within a 2- or 4-byte BIT\_STRING is dependent on the host architecture (MSB or LSB). In interpreting bit fields (BIT\_COLUMNS) within a BIT\_STRING, any necessary conversions such as byte swapping from LSB to MSB are done first, then bit field values (START\_BIT, BITS) are used to extract the appropriate bits. This procedure ensures that bit fields are not fragmented due to differences in hardware architectures.

### 3.7 Character Data

*Specification of character field format in ASCII and binary files pending.*

### 3.8 Format Specifications

Data format specifications provided in the FORMAT element serve two purposes:

1. In an ASCII TABLE data file or SPREADSHEET file, they provide a format which can be used in scanning the ASCII record for individual fields; and
2. In a binary data file, they provide a format that can be used to display the data values.

A subset of the FORTRAN data format specifiers is used for the values of FORMAT elements. Valid specifiers include:

Aw	Character data value
Iw	Integer value
Fw.d	Floating point value, displayed in decimal format
Ew.d[Ee]	Floating point value, displayed in exponential format

Where:

- w* is the total number of positions in the output field (including sign, decimal point, and exponentiation character – usually “E” – if any);
- d* is the number of positions to the right of the decimal point;
- e* is the number of positions in exponent length field.

### **3.9 Internal Representations of Data Types**

Appendix C contains the detailed internal representations of the PDS standard data types listed in Table 3.2.

The PDS has developed tools designed to use the specifications contained in Appendix C for interpreting data values for display and validation.

## aliases

- for data types, 3-1

## binary data

- bit string format, 3-6

- integer formats, 3-5

## bit field representation, 3-6

## BIT\_COLUMNS, 3-6

## BIT\_DATA\_TYPE

- standard values, 3-1

## BIT\_STRING, 3-6

## data type

- data elements, 3-1

## data types

- table of data elements, 3-2

- table of standard values, 3-4

## DATA\_TYPE

- standard values, 3-1

## floating point, 3-6

## floating point representation, 3-6

## format specifications, 3-6

- for ASCII data files, 3-6

- for binary data files, 3-6

## integer representations

- least significant byte first (LSB), 3-5

- most significant byte first (MSB), 3-5

- signed vs. unsigned, 3-5

## ITEM\_BYTES, 3-1

ITEM\_TYPE (*obsolete*), 3-1

## ITEMS, 3-1

LSB integers. *See* integer representations

MSB integers. *See* integer representations

*Planetary Science Data Dictionary* (PSDD), 3-1

## SAMPLE\_TYPE

- standard values, 3-1

## storage formats

- binary integers, 3-5

# Chapter 4. Data Objects and Products

At its simplest, a *data product* consists of a PDS label and the data object that it describes. More complex data products may contain several mutually dependent data objects, a primary object and one or more secondary objects, or both. In all cases, a single label is used to describe all parts of the product (even if they are held in separate physical files). A single PRODUCT\_ID value is defined for the entire set in that PDS label.

A data product is one component of a *data set* (see the *Data Set/Data Set Collection Contents and Naming* chapter of this document).

## **Primary Data Object**

A primary data object is a set of results from a scientific observation. Primary data objects are usually described using one of these PDS object structures:

TABLE  
SPREADSHEET  
IMAGE  
SERIES  
SPECTRUM

## **Secondary Data Object**

A secondary data object is any data used for processing or interpreting the primary data object(s), for example, a histogram derived from an image. Secondary data objects are usually described using one of these PDS object structures:

HISTOGRAM  
PALETTE  
HEADER

The PDS data product label, written in Object Description Language (ODL) (see the *Object Description Language (ODL) Specification and Usage* chapter of this document), defines both the physical and logical structure of the constituent data object(s).

## 4.1 Data Product File Configurations

The PDS label and data object may be in the same file or separate files. For data products with more than one object, the data objects may be in one or more files. In all cases, however, there must be exactly one PDS label containing exactly one `PRODUCT_ID` value. The `PRODUCT_ID` value must be unique within the data set containing this data product.

### *Example*

Consider a data product that consists of a 3-color image in which each color plane is stored in a separate physical file (that is, one file each for red, blue and green). Since all three colors are required to get the full image, this product contains three mutually dependent primary objects.

The label for this data product will contain a single `PRODUCT_ID`, three pointers to the separate data files, and three `IMAGE` object definitions. To aid in distinguishing between data files, the data preparer may also choose to include an `IMAGE_ID` keyword in each `IMAGE` object definition. The resulting PDS label would contain the following lines:

```

PRODUCT_ID      = "22A190"
...
^RED_IMAGE      = "22A190R.IMG"
^GREEN_IMAGE    = "22A190G.IMG"
^BLUE_IMAGE     = "22A190B.IMG"
...
OBJECT          = RED_IMAGE
  IMAGE_ID      = "22A190-RED"
...
END_OBJECT      = RED_IMAGE

OBJECT          = GREEN_IMAGE
  IMAGE_ID      = "22A190-GREEN"
...
END_OBJECT      = GREEN_IMAGE

OBJECT          = BLUE_IMAGE
  IMAGE_ID      = "22A190-BLUE"
...
END_OBJECT      = BLUE_IMAGE

```

Figure 4.1 illustrates file configurations for a data product with a single data object.

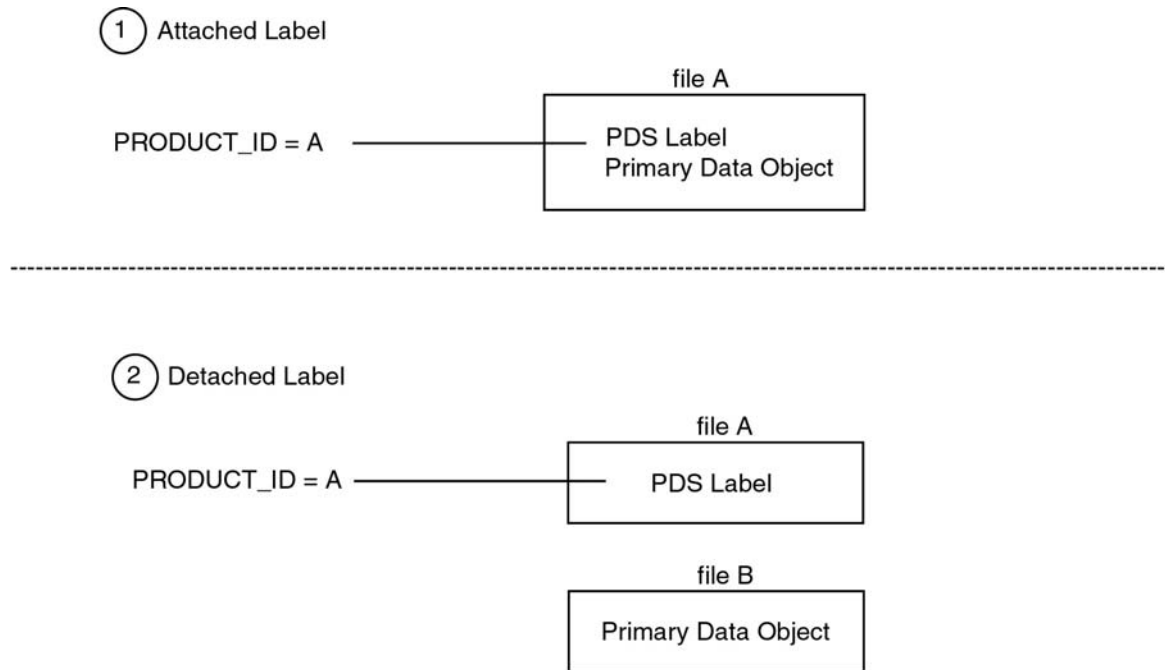

**Figure 4.1 Data Product with a Single Data Object**

Figure 4.2 shows the possible file configurations for a single data product consisting of one primary and one secondary data object. Similar examples could be made using data products composed of more than two data objects.

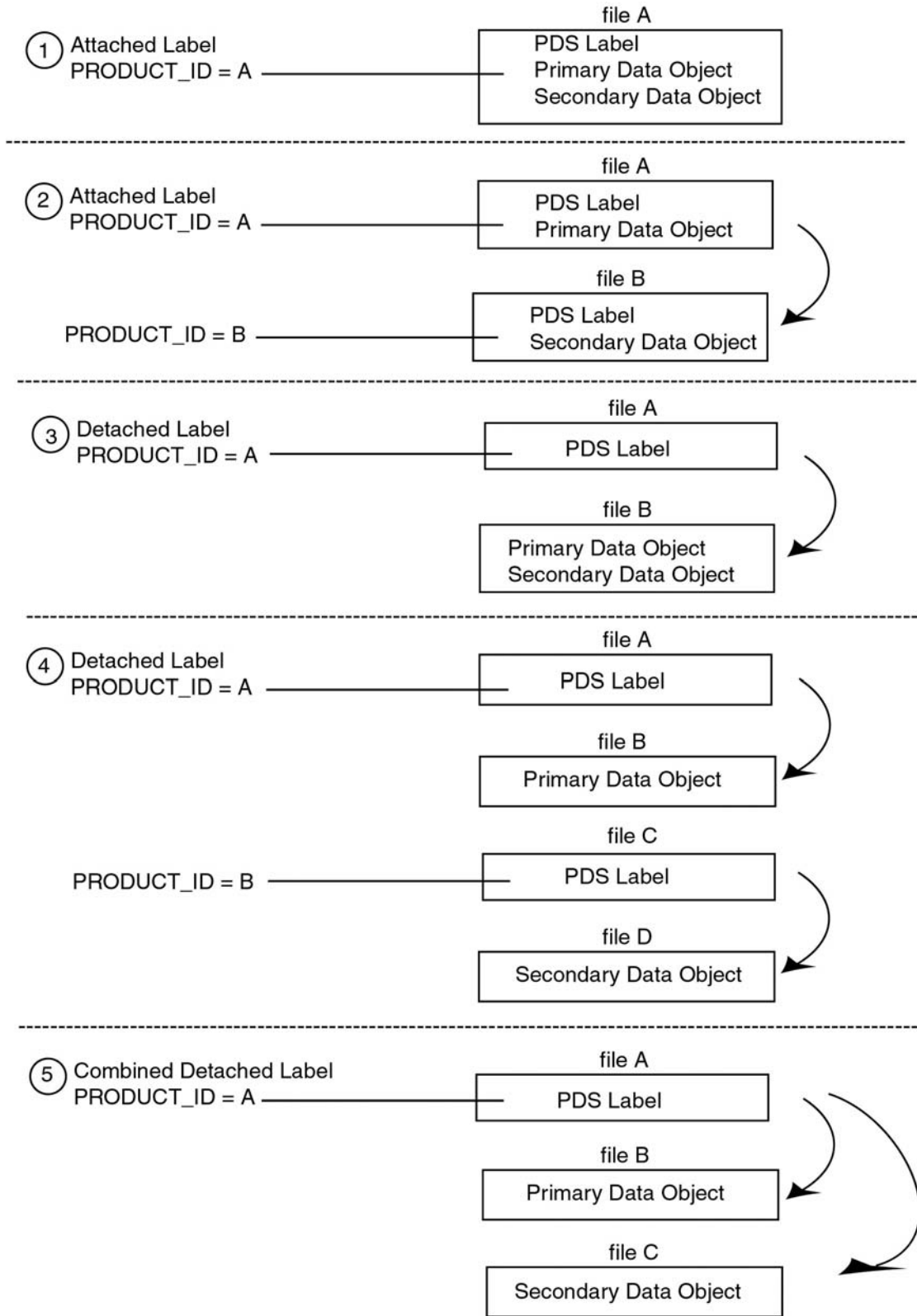

**Figure 4-2. Data Product with Multiple Data Objects**



- data product
  - and PRODUCT\_ID, 4-1
  - definition, 4-1
  - file configurations, 4-2**
  - label example, 4-2
  - primary data object, 4-1
  - secondary data object, 4-1
- HEADER object
  - secondary data object, 4-1
- HISTOGRAM object
  - secondary data object, 4-1
- IMAGE object
  - primary data object, 4-1
- PALETTE object
  - secondary data object, 4-1
- primary data object
  - IMAGE object, 4-1
  - SERIES object, 4-1
  - SPECTRUM object, 4-1
  - SPREADSHEET object, 4-1
  - TABLE object, 4-1
- PRODUCT\_ID, 4-1
  - secondary data object
    - HEADER object, 4-1
    - HISTOGRAM object, 4-1
    - PALETTE object, 4-1
- SERIES object
  - primary data object, 4-1
- SPECTRUM object
  - primary data object, 4-1
- SPREADSHEET object
  - primary data object, 4-1
- TABLE object
  - primary data object, 4-1

# Chapter 5. Data Product Labels

PDS data product labels are required for describing the contents and format of each individual data product within a data set. PDS data product labels are written in the Object Description Language (ODL). The PDS has chosen to label the wide variety of data products under archival preparation by implementing a standard set of data object definitions, group definitions, data elements, and standard values for the elements. These data object definitions, data elements, and standard values are defined in the *Planetary Science Data Dictionary* (PSDD). Appendix A of this document provides general descriptions and examples of the use of these data object definitions and data elements for labeling data products.

## 5.1 Format of PDS Labels

### 5.1.1 Labeling methods

In order to identify and describe the organization, content, and format of each data product, PDS requires a distinct data product label for each individual data product file. These distinct product labels may be constructed in one of three ways:

Attached - The PDS data product label is attached at the beginning of the data product file. There is one label attached to each data product file.

Detached - The PDS data product label is detached from the data and resides in a separate file which contains a pointer to the data product file. There is one detached label file for every data product file. The label file should have the same base name as its associated data file, but the extension .LBL .

Combined Detached - A single PDS detached data product label file is used to describe the contents of more than one data product file. The combined detached label contains pointers to individual data products.

NOTE: Although all three labeling methods are equally acceptable, the PDS tools do not currently support the Combined Detached label option.

Figure 5.1 illustrates the use of each of these methods for labeling individual data product files.

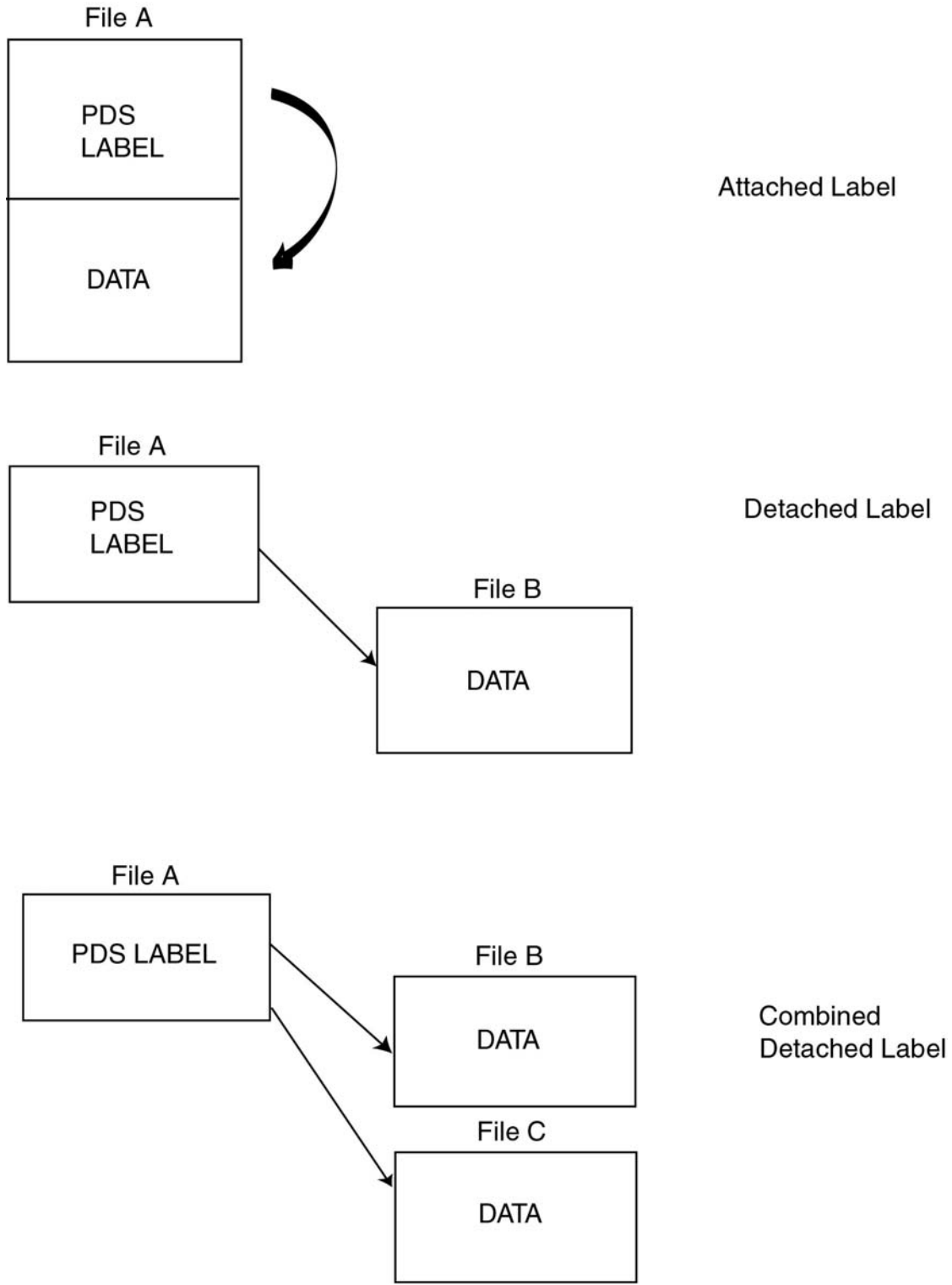

**Figure 5.1 Attached, Detached, and Combined Detached PDS Labels**

### 5.1.2 Label format

PDS recommends that labels have stream record format, and line lengths of at most 80 characters (including the CR/LF line terminators) so that the entire label can be seen on a computer screen without horizontal scrolling. The carriage return and line feed (CR/LF) pair is the required line terminator for all PDS labels. (See the *Record Formats* chapter of this document.)

All values in a PDS label should be in upper case, except values for descriptive elements (DESCRIPTION, NOTE, etc.). It is also recommended that the equal signs in the labels be aligned for ease of reading.

#### ASCII Character Set

All values in a PDS label must conform to the standard 7-bit ASCII character set. Labels may include characters in the range of ASCII characters 32 through 127 (decimal), and the record delimiters Line Feed (10 decimal) and Carriage Return (13 decimal).

The remaining 7-bit ASCII characters (1-9, 11, 12, and 14-31 decimal, which includes the horizontal and vertical tab and form feed characters) are not permitted in PDS labels. Note that the 8-bit characters 128 through 255 (decimal) are not used in the PDS as the interpretation of these characters varies by operating system, computer platform, and font selected. Specifically, extended-set characters with diacritical marks are not to be used as they are interpreted differently by different applications.

#### Label Padding

When a fixed length data file has an attached label, the label is padded with space characters (ASCII 32 decimal) in one of the following ways:

1) Spaces are added after the label's END <CR><LF> statement and before the data so that the total of the label (in bytes) is an integral multiple of the record length of the data. In this case, LABEL\_RECORDS is calculated by dividing the total padded length of the label section, in bytes, by the stated value of RECORD\_BYTES.

#### *Example*

In the example below, the label portion of the file is  $7 \times 324 = 2268$  bytes in length, including blank fill between the END<CR><LF> statement and the first byte of data. The actual data portion of the file starts at record 8 (i.e., the 1st byte of the 8th record starts at byte  $(7 \times 324)+1 = 2269$ )

```

RECORD_TYPE           = FIXED_LENGTH<CR><LF>
RECORD_BYTES          = 324<CR><LF>
FILE_RECORDS          = 334<CR><LF>
LABEL_RECORDS         = 7<CR><LF>

^IMAGE                = 8<CR><LF>

END<CR><LF>
....blank fill....
data
```

2) Each line in the label may be padded with space characters so that each line in the label has the same record length as the data file. In this case, the label line length may exceed the recommended 80 characters; LABEL\_RECORDS is the number of physical records in the label section of the file.

### *Example*

In the example below, the label portion of the file is  $80 \times 85 = 6800$  bytes in length. Each line in the label portion of the file is 85 bytes long, the same length as each data record. Notice the blank space between the actual values in the label and the line delimiters. In the example, the label is 80 lines long (i.e., 80 records long) and the data begin at record 81. Note that the label is padded so that <CR><LF> are in bytes 84 and 85.

```

RECORD_TYPE           = FIXED_LENGTH   <CR><LF>
RECORD_BYTES         = 85              <CR><LF>
FILE_RECORDS         = 300             <CR><LF>
LABEL_RECORDS        = 80              <CR><LF>
...
^TABLE                = 81             <CR><LF>
END                   <CR><LF>
Data

```

## 5.2 Data Product Label Content

### 5.2.1 Attached and Detached Labels

PDS data product labels have a general structure that is used for all attached and detached labels, except for data products described by minimal labels. (Minimal labels are described in Section 5.2.3.)

- LABEL STANDARDS identifier
- FILE CHARACTERISTIC data elements
- DATA OBJECT pointers
- IDENTIFICATION data elements
- DESCRIPTIVE data elements
- DATA OBJECT DEFINITIONS
- END statement

Figure 5.2 provides an example of how this general structure appears in a.14 TD B2([x1Ea)-Tc 0.001D -0.006(e)

PDS LABEL		
PDS_VERSION_ID	=	• LABEL STANDARDS IDENTIFIERS
/*FILE_CHARACTERISTICS */		• FILE CHARACTERISTICS DATA ELEMENTS
RECORD_TYPE	=	
RECORD_BYTES	=	
FILE_RECORDS	=	
LABEL_RECORDS	=	
/*POINTERS TO DATA OBJECTS */		• DATA OBJECT POINTERS (primary, secondary)
^IMAGE	=	
^HISTOGRAM	=	
/*IDENTIFICATION DATA ELEMENTS */		• IDENTIFICATION DATA ELEMENTS
DATA_SET_ID	=	
PRODUCT_ID	=	
SPACECRAFT_NAME	=	
INSTRUMENT_NAME	=	
TARGET_NAME	=	
START_TIME	=	
STOP_TIME	=	
.		
.		
.		
PRODUCT_CREATION_TIME	=	
/*DESCRIPTIVE DATA ELEMENTS */		• DESCRIPTIVE DATA ELEMENTS
FILTER_NAME	=	
OFFSET_MODE_ID	=	
.		
.		
.		
/*DATA OBJECT DEFINITIONS */		• DATA OBJECT DEFINITIONS (primary, secondary)
OBJECT	= IMAGE	
.		
.		
.		
END_OBJECT	= IMAGE	
OBJECT	= HISTOGRAM	
.		
.		
.		
END_OBJECT	= HISTOGRAM	
END		• END STATEMENT

*Figure 5.2 PDS Attached / Detached Label Structure*

## 5.2.2 Combined Detached Labels

For the Combined Detached label option, the general label structure is modified slightly to reference each individual file within its own FILE object explicitly. In addition, identification and descriptive data elements that apply to all of the files can be located before the FILE objects.

- LABEL STANDARDS identifiers
- IDENTIFICATION data elements that apply to all referenced data files
- DESCRIPTIVE data elements that apply to all referenced data files
- OBJECT=FILE statement (Repeats for each data product file)
  - FILE CHARACTERISTIC data elements
  - DATA OBJECT pointers
  - IDENTIFICATION data elements
  - DESCRIPTIVE data elements
  - DATA OBJECT DEFINITION
- END\_OBJECT=FILE statement
- END statement

Figure 5.3 provides an example of how this general structure appears in a combined detached label that describes more than one data product file.

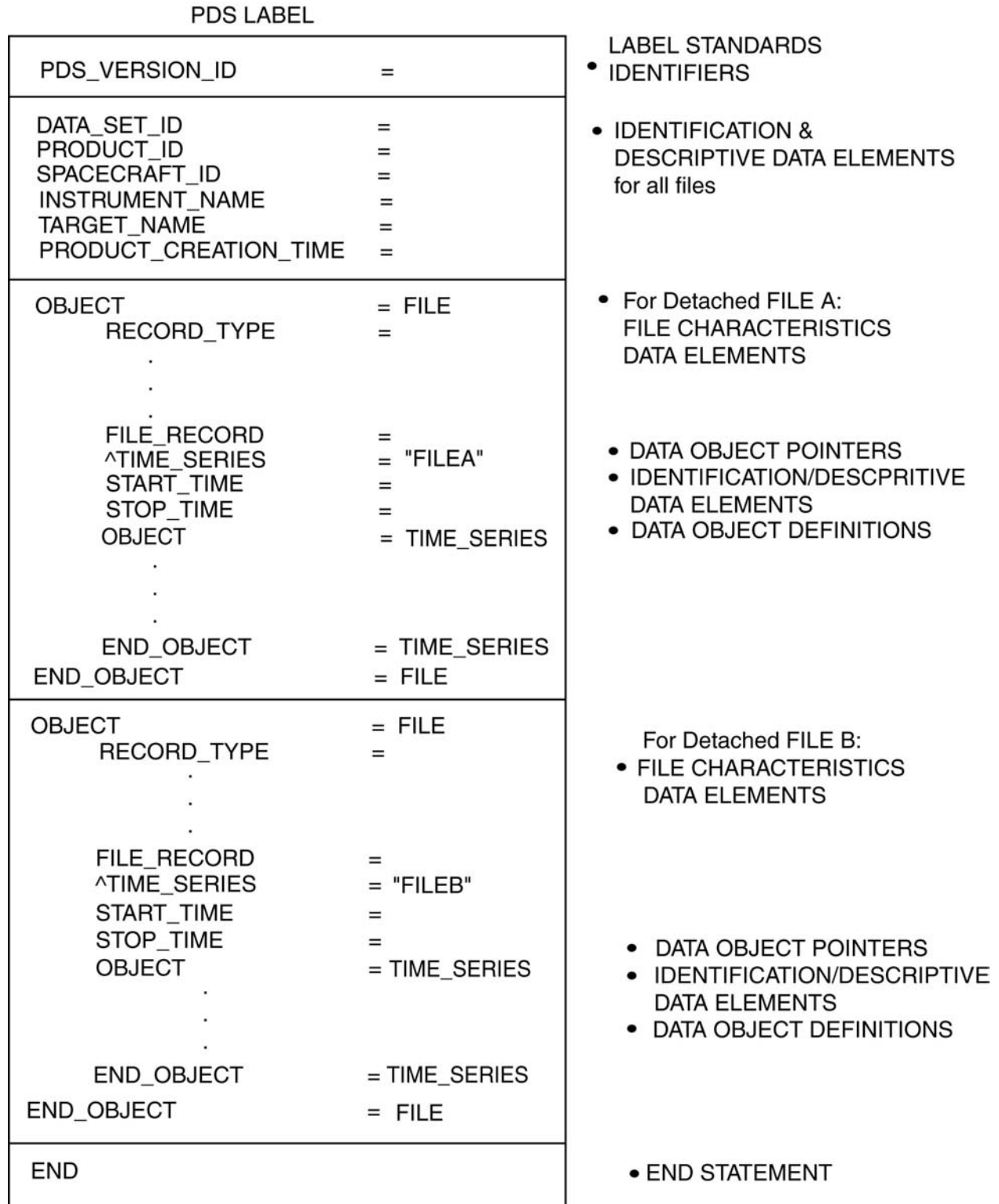

*Figure 5.3 PDS Combined / Detached PDS Label Structure*



### 5.2.3 Minimal Labels

Use of the minimal label option is only allowed when the format of the data cannot be supported by any PDS data object structure other than the FILE object.

For minimal labels the required use of data objects is waived. A minimal label does not require any explicit PDS data object definitions or pointers to data objects. This applies to both attached and detached labels.

Minimal labels must satisfy the following requirements:

- (1) Provide the ability to locate the data associated with the label.

- 1a. Attached labels

Since data objects and pointers are not required in the minimal label, by definition the data follow immediately after the label.

- 1b. Detached Labels

Both the implicit and explicit use of the FILE object are supported. The FILE\_NAME keyword is required in the explicit FILE object, or in the label itself if no FILE object is included.

- (2) Provide the ability to locate a description of the format/content of the data. One of the following must be provided in the minimal label:

- 2a. ^DESCRIPTION = "<filename>"

This is a pointer to a file containing a detailed description of the data format, which may be located in the same directory as the data or in the DOCUMENT subdirectory.

- 2b. DESCRIPTION = "<text appears here>"

This is either a detailed description of the data file, its format, data types, and use, or it is a reference to a document available externally, e.g., a Software Interface Specification (SIS) or similar document.

- (3) When minimal labels are used, DATA\_OBJECT\_TYPE = FILE should be used in the DATA\_SET catalog file

### 5.2.3.1 Implicit File Object (Attached and Detached Minimal Label)

The general structure for minimal labels with implicit file objects is as follows:

- LABEL STANDARDS identifier
- FILE CHARACTERISTIC data elements
- IDENTIFICATION data elements
- DESCRIPTIVE data elements
- END statement

### 5.2.3.2 Explicit File Object (Detached Minimal Label)

The general structure for minimal labels with explicit file objects is as follows:

- LABEL STANDARDS identifier
- IDENTIFICATION data elements
- DESCRIPTIVE data elements
- OBJECT=FILE statement
  - FILE CHARACTERISTIC data elements
- END\_OBJECT=FILE
- END statements

Figure 5.4 provides an example of how this general structure appears in a detached minimal label. In this example, an implicit FILE object is used.

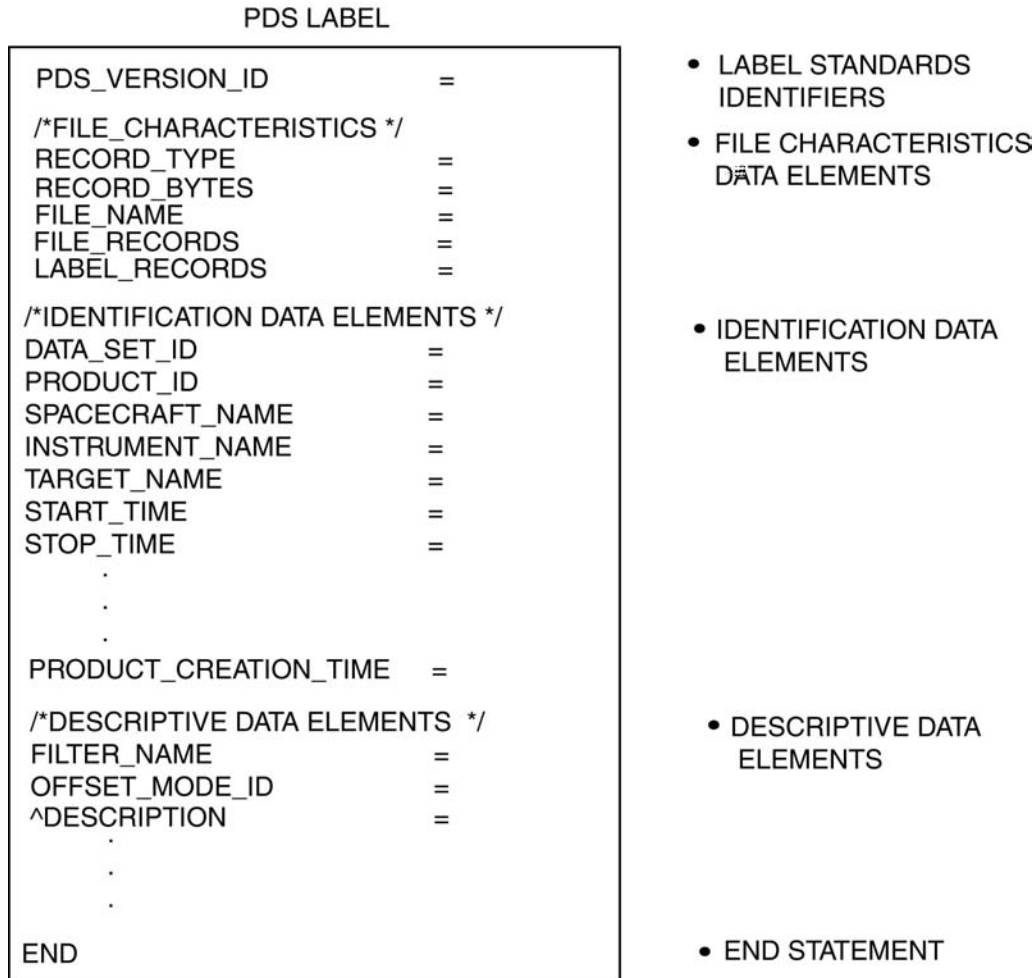

*Figure 5.4 PDS Detached Minimal Label Structure*

### 5.3 Detailed Label Contents Description

This section describes the detailed requirements for the content of PDS labels. The subsections describe label standards identifiers, file characteristic data elements, data object pointers, identification data elements, descriptive data elements, data object definitions, and the END statement.

#### 5.3.1 Label Standards Identifiers

Each PDS label must begin with the PDS\_VERSION\_ID data element. This element identifies the published version of the Standards to which the label adheres, for purposes of both validation as well as software development and support. For labels adhering to the standards described in this document (the *PDS Standards Reference*, Version 3.4), the appropriate value is “PDS3”:

```
PDS_VERSION_ID = PDS3
```

The PDS does not require Standard Formatted Data Unit (SFDU) labels on individual products, but they may be desired for conformance with specific project or other agency requirements. When SFDU labels are provided on a PDS data product, the SFDU label must *precede* the PDS\_VERSION\_ID keyword, thus:

```
CCSD... [optional SFDU label]
PDS_VERSION_ID
LABEL_REVISION_NOTE
```

SFDU labels in PDS products must follow the format standards described in *SFDU Usage* chapter in this document.

The LABEL\_REVISION\_NOTE element is a free form, unlimited-length character string providing information regarding the revision status and authorship of a PDS label. It should include at least the latest revision date and the author of the current version, but may include a complete editing history. This element is required in all catalog labels.

### *Example*

```
PDS_VERSION_ID           = PDS3
LABEL_REVISION_NOTE      = "1999-08-01, Anne Raugh (SBN), initial release;"
RECORD_TYPE              = FIXED_LENGTH
RECORD_BYTES             = 80
```

## 5.3.2 File Characteristic Data Elements

PDS data product labels contain data element information that describes important attributes of the physical structure of a data product file. The PDS file characteristic data elements are:

```
RECORD_TYPE
RECORD_BYTES
FILE_RECORDS
LABEL_RECORDS
```

The RECORD\_TYPE data element identifies the record characteristics of the data product file. A complete discussion of the RECORD\_TYPE data element and its use in describing data products produced on various platforms is provided in the *Record Formats* chapter in this document. The RECORD\_BYTES data element identifies the number of bytes in each physical record in the data product file. The FILE\_RECORDS data element identifies the number of physical records in the file. The LABEL\_RECORDS data element identifies the number of physical records that make up the PDS product label.

Not all of these data elements are required in every data product label. Table 5.1 lists the required (Req) and optional (Opt) file characteristic data elements for a variety of data products and labeling methods for both attached (Att) and detached (Det) labels. Where (max) is specified, the value indicates the maximum size of any physical record in the file.

**Table 5.1: File Characteristic Data Element Requirements**

Labeling Method	Att	Det	Att	Det	Att	Det	Att	Det
RECORD_TYPE			FIXED_LENGTH	VARIABLE_LENGTH	STREAM		UNDEFINED	
RECORD_BYTES	Req	Req	Rmax	Rmax	Omax	-	-	-
FILE_RECORDS	Req	Req	Req	Req	Opt	Opt	-	-
LABEL_RECORDS	Req	-	Req	-	Opt	-	-	-

*Note:* The FILE\_NAME keyword is required in detached minimal labels.

### 5.3.3 Data Object Pointers

“Data objects” are the actual data for which the structure and attributes are defined in a PDS label. Each data product file contains one or more data objects. The PDS uses a pointer within the product labels to identify the file locations for all objects in a data product.

#### *Example*

```
^TABLE = "DATA.DAT"
^TABLE = ("DATA.DAT", 10 <BYTES>)
```

#### 5.3.3.1 Use of Pointers in Attached Labels

Data object pointers are required in labels with one exception: attached labels that refer to only a single object. In the absence of a pointer, the data object is assumed to start in the next physical record after the PDS product label area. This is commonly the case with ASCII text files described by a TEXT object and ASCII SPICE files described by a SPICE\_KERNEL object. The top two illustrations in Figure 5.5 show example files that do not require data object pointers.

Object pointers are required for all data objects, even when multiple data objects are stored in a single data product file. Data object pointers in attached labels take one of two forms:

`^<object_identifier> = nnn`

where nnn represents the starting record number within the file (first record is numbered 1),  
Or,

`^<object_identifier> = nnn <BYTES>`

where nnn represents the starting byte location within the file (first byte is numbered 1).

See Chapter 12, *Object Description Language (ODL) Specification and Usage*, and Chapter 14, *Pointer Usage*, in this document for a complete description of pointer syntax.

The bottom two illustrations in Figure 5.5 show the use of required data object pointers for

attached label products containing multiple data objects.

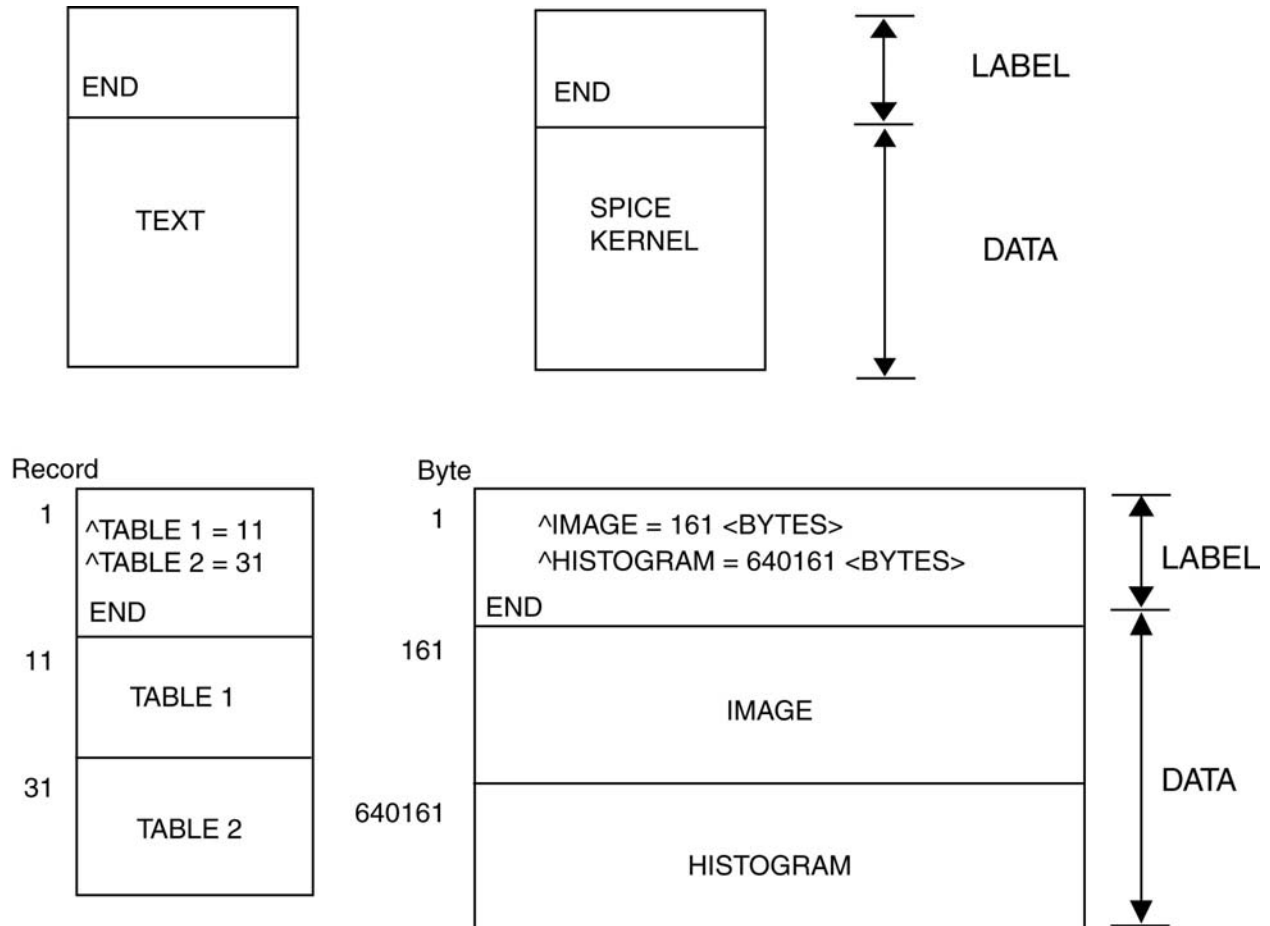

*Figure 5.5 Data Object Pointers-Attached Labels*

### 5.3.3.2 Use of Pointers in Detached and Combined Detached Labels

When the PDS data product label is a detached or a combined detached label, data object pointers are required for all data objects referenced.

The syntax for these data object pointers takes one of three forms:

- (1)  $\wedge object\_identifier = \text{"filename"}$
- (2)  $\wedge object\_identifier = (\text{"filename"}, nnn)$
- (3)  $\wedge object\_identifier = (\text{"filename"}, nnn <BYTES>)$

With respect to the above three cases:

- (a) These object pointers reference either byte or record locations in data files that are detached, or separate from, the label file.
- (b) “Filename” is the name of the detached data file. File names must be in uppercase characters.
- (c) When no offset is specified, the first record is assumed.
- (d) Records and bytes are numbered from 1.

In the first case, the data object is located at the beginning of the referenced file. In the second case, the data object begins with the  $nnn^{\text{th}}$  physical record from the beginning of the referenced file. In the third case, the data object begins with the  $nnn^{\text{th}}$  byte from the beginning of the referenced file.

### *Examples*

```

^IMAGE                = ("DATA.IMG")
^ENGINEERING_TABLE   = ("DATA.DAT", 10)
^TABLE                = ("DATA.TAB", 10 <BYTES>)

```

Figure 5.6 contains several examples of data object pointer usage for data product files with detached or combined detached labels. The top example shows a data product consisting of a HEADER data object and a TABLE data object together in a single file. The detached label for this product includes pointers for both data objects, with the TABLE object starting at byte 601 of file A. The middle example illustrates a combined detached label for a data product contained in two data objects, each in a separate file. A separate pointer is provided for each data object. The bottom example shows a detached label for a data product containing multiple data objects.

The third example shows a complex data file structure. The HEADER object comes first in the data file and, as the pointer (“^HEADER”) shows, it requires no explicit offset (record 1 is assumed). Two parallel objects, a TABLE and an IMAGE, then follow the header. For this section of the file, each record contains one row of the TABLE followed by one line of the IMAGE. In the TABLE object description, the bytes of the IMAGE are accounted for as ROW\_SUFFIX\_BYTES; in the IMAGE object description, the bytes of the TABLE object are accounted for as LINE\_PREFIX\_BYTES. Both objects start in the same record, and therefore have the same offset (4). See the IMAGE and TABLE object descriptions for more information on prefix and suffix bytes. Had this data file been organized sequentially (so that, for example, the HEADER was followed by the TABLE, which in turn was followed by the IMAGE), then each object would have had its own offset.

### **5.3.3.3 Note Concerning Minimal Attached and Detached Labels**

Data object pointers do not exist in minimal labels. In these cases the format of the data is usually fully described in a separate file or document.

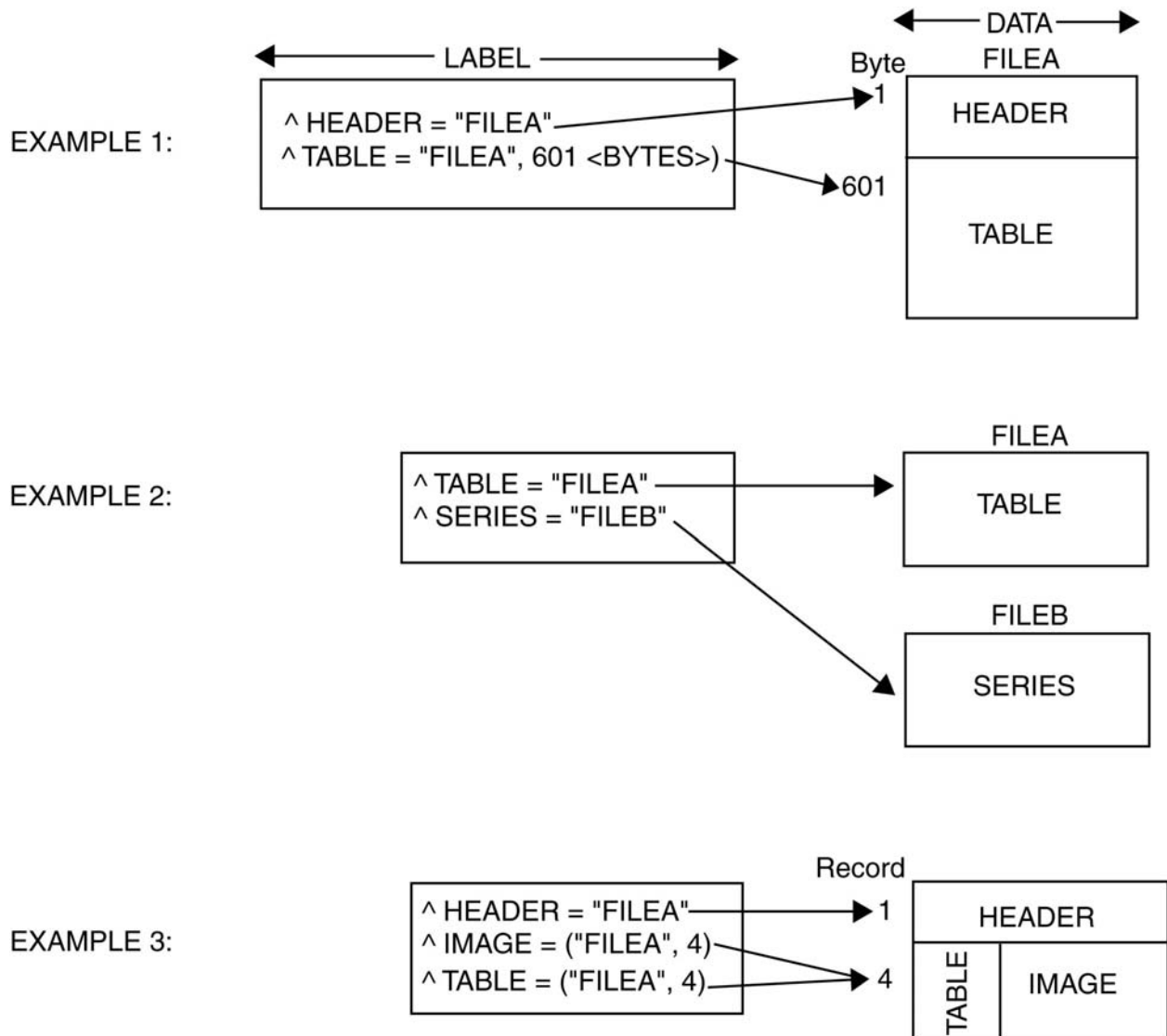

*Figure 5.6 Data Object Pointers – Detached & Combined Labels*

### 5.3.4 Data Identification Elements

The data identification elements provide additional information about a data product that can be used to relate the product to other data products from the same data set or data set collection. The minimum set of identification elements required by the PDS standards (see the following subsections) is sufficient to populate a high-level database like, for example, the PDS central catalog. In addition, data preparers will choose additional identification elements from the *Planetary Science Data Dictionary* (PSDD) to support present and future cataloging and search operations.

NOTE: When a data preparer desires a new element for a data product label - one not yet recorded in the PSDD - it can be proposed for addition to the dictionary. Contact a PDS Data Engineer for assistance.



### 5.3.4.1 Spacecraft Science Data Products

The following data identification elements must be included in product labels for all spacecraft science data products:

```
DATA_SET_ID
PRODUCT_ID
INSTRUMENT_HOST_NAME
INSTRUMENT_NAME
TARGET_NAME
START_TIME
STOP_TIME
SPACECRAFT_CLOCK_START_COUNT
SPACECRAFT_CLOCK_STOP_COUNT
PRODUCT_CREATION_TIME
```

### 5.3.4.2 Earthbased Science Data Products

The following data identification elements must be included in product labels for all Earth-based science data products:

```
DATA_SET_ID
PRODUCT_ID
INSTRUMENT_HOST_NAME
INSTRUMENT_NAME
TARGET_NAME
START_TIME
STOP_TIME
PRODUCT_CREATION_TIME
```

### 5.3.4.3 Ancillary Data Products

The following data identification elements must be included in product labels for all ancillary data products. Ancillary products may be more general in nature, supporting a wide variety of instruments for a particular mission. For example, SPICE data sets, general engineering data sets, and uplink data are considered ancillary data products.

```
DATA_SET_ID
PRODUCT_ID
PRODUCT_CREATION_TIME
```

The following identification elements are highly recommended, and should be included in ancillary data products whenever they apply:

```
INSTRUMENT_HOST_NAME
INSTRUMENT_NAME
TARGET_NAME
START_TIME
STOP_TIME
SPACECRAFT_CLOCK_START_COUNT
SPACECRAFT_CLOCK_STOP_COUNT
```

### 5.3.5 Descriptive Data Elements

In addition to the data identification elements required for various types of data, PDS strongly recommends including additional data elements related to specific types of data. These descriptive elements should include any elements needed to interpret or process the data objects or which would be needed to catalog the data product to support potential search criteria at the product level.

Recommendations for descriptive data elements to be included come from the PDS mission interface personnel as well as the data producer's own suggestions. These additional data elements are selected from the *Planetary Science Data Dictionary*.

NOTE: When a data element is needed for a data product label, but is not yet recorded in the PSDD, it may be proposed for addition to the dictionary. Contact a PDS data engineer for assistance in submitting new data elements for inclusion in the PSDD.

Pointers are sometimes used in a PDS label to provide a shorthand method for referencing either a set of descriptive data elements (e.g., ^DESCRIPTION) or a long descriptive text passage relevant to several data product labels.

### 5.3.6 Data Object Definitions

The PDS requires a separate data object definition within the product label for each object in the product, to describe the structure and associated attributes of each constituent object. Each object definition, whether for a primary or a secondary object, must have a corresponding object pointer as described in Section 5.3.3.

Object definitions are of the form:

```
OBJECT           = aaa      where aaa is the name of the data object
...
END_OBJECT      = aaa
```

The PDS has designed a set of standard data object definitions to be used for labeling products. Among these standard objects are those designed to describe structures commonly used for scientific data storage. Appendix A provides the complete set of PDS object definition requirements, along with examples of product labels.

Pointers are sometimes used in a PDS label to provide a shorthand method for including a standard set of sub-objects referenced in several data product labels. For example, a pointer called “^STRUCTURE” is often used to include a set of COLUMN sub-objects for a TABLE structure used in many labels of the same data set.

### 5.3.7 End Statement

The END statement ends a PDS label. Where required by an outside agency, the END statement may be followed by one or more SFDU labels.

The PDS does not require SFDU labels on individual products, but they may be required to conform with specific project or other agency requirements. If SFDUs are provided on a data product, they must follow the standards described in the *SFDU Usage* chapter in this document. In some, but not all cases, another SFDU label is required after the PDS END statement to provide “end label” and sometimes “start data” information.

## 5.4 Syntax for Element Values

The values of keywords must be expressed in a manner appropriate to the type of the keyword. Data types for element values are specified in the element definitions contained in the PSDD. The syntax rules for expressing these values in PDS labels are discussed in detail in Section 12.3 of Chapter 12: *Object Description Language Specification and Usage*. A brief summary is provided here for reference.

### Character Strings

Character strings are enclosed in double quotes unless they consist entirely of uppercase letter, number, and/or underscore ( `_` ) characters.

#### *Examples*

NAME	= FILTER	Correct
NAME	= "FILTER WAVELENGTH"	Correct
NAME	= FILTER_WAVELENGTH	Correct
NAME	= FILTER WAVELENGTH	<i>Incorrect</i>

### Integers

Integer values must be presented as a string of digits, optionally preceded by a sign. Specifically, no comma or point should be used to group digits. Values that are to be interpreted as integers must not be enclosed in quotation marks of any kind.

#### *Examples*

ITEMS	= 12	Correct
REQUIRED_STORAGE_BYTES	= 43364	Correct
ITEMS	= "12"	<i>Incorrect</i>
REQUIRED_STORAGE_BYTES	= 43,364	<i>Incorrect</i>

**Floating-Point Numbers**

Real data values may be expressed as either floating-point numbers with a decimal point or in scientific notation with an exponent. Scientific notation is formatted in the standard manner for program I/O, using the letter “E” as an exponentiation operator. Values that are to be interpreted as real numbers must not be enclosed in quotation marks of any kind.

***Examples***

TELESCOPE_LATITUDE	= 33.476	Correct
TELESCOPE_LATITUDE	= 3.3476E+01	Correct
TELESCOPE_LATITUDE	= "33.476"	<i>Incorrect</i>
TELESCOPE_LATITUDE	= 3.3476 x 10^01	<i>Incorrect</i>

**Dates and Times**

Date and time values must be in the PDS standard date/time format: *YYYY-MM-DDThh:mm:ss.sss*. Date and time values must never be enclosed in quotes of any kind.

***Examples***

START_TIME	= 1990-08-01T23:59:59	Correct
START_TIME	= "1990-08-01T23:59:59"	<i>Incorrect</i>

**5.5 Locally-defined Data Elements**

The PSDD contains a large set of common (global) data elements (keywords) and small sets of locally-defined data elements. The set of common data elements are available for use in any label. Locally-defined data elements may only be used in data product labels.

**5.5.1 Justification for Locally-defined Data Elements**

There are two justifications for when a locally-defined keyword can be created:

- the scope of use is limited / local to a small set of data products within a single mission or campaign, or is so specific that only a very few data providers would make use of the locally-defined data element (keyword).

Examples of data elements in the PSDD having limited scope:

**MAXIMUM B1950 RING LONGITUDE [PDS-RINGS]**

The maximum\_B1950\_ring\_longitude element specifies the maximum inertial longitude within a ring area relative to the B1950 prime meridian, rather than to the J2000 prime meridian. The prime meridian is the ascending node of the planet's invariable plane on the Earth's mean equator of B1950. Longitudes are measured in the direction of orbital motion

along the planet's invariable plane to the ring's ascending node, and thence along the ring plane. Note: For areas that cross the prime meridian, the maximum ring longitude will have a value less than the minimum ring longitude.

### **INSTRUMENT FORMATTED DESC [PDS-CN]**

The `instrument_formatted_desc` element contains the formatted instrument descriptions. These descriptions represent the information collected for the PDS Version 1.0 instrument model and were created by extracting instrument information from several tables in the catalog data base.

These descriptions represent an archive since the tables have been eliminated as part of the catalog streamlining task.

### **DATA SET LOCAL ID [PDS-SBN]**

The `DATA_SET_LOCAL_ID` element provides a short (of order 3 characters) acronym used as the local ID of a data set (Example value: IGLC). It may also appear as the first element of file names from a particular `DATA_SET` (Example value:IGLCINDX.LBL).

b) the common instance, and any other local instances, currently defined in the PSDD are inadequate in some descriptive capacity:

- the data element definition is too restrictive or inappropriate
- the length of the keyword-value is too short
- different types of units

A possible scenario for the above could be that the Cassini mission wants to use the `DATA_QUALITY_ID` keyword.

### **DATA QUALITY ID [PSDD] - CHAR(3)**

The `data_quality_id` element provides a numeric key which identifies the quality of data available for a particular time period. The `data_quality_id` scheme is unique to a given instrument and is described by the associated `data_quality_desc` element.

But, the Cassini mission wants to re-use the data element in a way that is different from the instance(s) currently defined in the PSDD.

### **DATA QUALITY ID [CASSINI] - CHAR(50)**

The `data_quality_id` element provides a short acronym or identifier of the qualitative state in which the data resided when the data was generated by the instrument team. The `data_quality_id` is unique to the Cassini mission and is described by the associated `data_quality_desc` element.

### 5.5.2 Identification of Locally-defined Data Elements

Locally-defined instances of data elements (keywords) are identified in data product labels as:

`<namespace>:<keyword_name>`

where `<namespace>` is the unique namespace to which the keyword is designated.

`<keyword_name>` is the name of the keyword being included in the data product label.

If there are multiple instances of a keyword, then the specific instance of use is identified as follows:

Example:

```
TARGET_NAME = "EARTH"           (namespace = PSDD)
CASSINI:TARGET_NAME = "EARTH"   (namespace = CASSINI)
VOYAGER:TARGET_NAME = "MARS"    (namespace = VOYAGER)
```

In the above example, the PSDD contains three separate instances of the TARGET\_NAME keyword:

- a) the common (PSDD) instance which the PDS defined and which the PDS community at large agreed upon.
- b) the CASSINI instance which the Cassini project defined.
- c) the VOYAGER instance which the Voyager project defined.

### 5.5.3 Review and Use of Locally-defined Data Elements

The following are recommendations on the review and use of locally defined keywords:

1. The custodian of a namespace is to be a PDS node; or the entity to which the PDS node delegates authority (e.g., mission); or other agencies in a cooperative agreement with NASA and working with the PDS (e.g., ESA).
2. The custodian has initial responsibility for NAMESPACE and all locally defined elements which use the NAMESPACE.
3. The responsibility for NAMESPACE may be transferred if agreeable to the custodian and the receiving party.
4. The responsibility for locally defined elements may be transferred if agreeable to the custodian and the receiving party.

5. Custodians (e.g., missions/campaigns) being phased out are expected to transfer all responsibilities to a continuing party (i.e., there is always a responsible party actively engaged in overseeing the use of the NAMESPACE and locally defined elements which use the NAMESPACE).
6. Control authority (responsible party) has absolute authority over element definitions.
7. A non-originating user who reuses a locally defined keyword must conform to interpretations of the control authority, including retroactive adjustments (i.e., the user of a locally defined keyword is at risk that the control authority may alter one or more of the keyword attributes; such as the definition, without notifying outside users of the change).
8. PDS recommends that non-originating users "clone" elements into a new local dictionary rather than reusing them (e.g., CASSINI:DATA\_QUALITY\_ID would become MER:DATA\_QUALITY\_ID if reused by the MER mission). This is because non-originating users are at risk that the keyword may be altered by the control authority and the control authority does not have an obligation to notify anyone of the change.
9. 'Promoting' locally defined keywords to full PSDD standing is not permitted (i.e., locally defined keywords remain locally defined throughout the life of the keyword). A locally defined keyword may be proposed independently for use in the global PSDD by submitting the keyword element definition for the full PSDD approval process.
10. Locally defined keywords should not take on a scope outside of the originating mission/campaign.

- data elements
  - data identification, 5-15
  - descriptive, 5-17
  - file characteristics, 5-11
  - locally defined, 5-19
  - proposing new, 5-15
  - required and optional, 5-11
  - standards identifiers, 5-10
  - syntax
    - summary, 5-18
- data identification data elements, 5-15
- data identification elements
  - required for ancillary data, 5-16
  - required for Earth-based data, 5-16
  - required for spacecraft data, 5-16
- data objects
  - definition of, 5-12
  - object definitions, 5-17
  - standard data objects, 5-17
- data products
  - labels, 5-1
- descriptive data elements, 5-17
- END statement, 5-18
- file characteristics data elements, 5-11
- FILE object
  - explicit, 5-9
  - implicit, 5-9
- FILE\_NAME, 5-12
- FILE\_RECORDS, 5-11
- Label**
  - structure
    - combined detached example, 5-7
- LABEL\_RECORDS, 5-11
- LABEL\_REVISION\_NOTE, 5-11
- labeling methods, 5-1
  - attached, 5-1
  - case, 5-3
  - combined detached, 5-1
  - detached, 5-1
  - example, 5-1
  - line lengths, 5-3
- labels, 5-1
  - and SFDU labels, 5-11, 5-18
  - attached, 5-1



- case, 5-3
- combined detached, 5-1, 5-6
- descriptive text pointers, 5-17
- detached, 5-1
- END statement, 5-18
- FILE object
  - explicit, 5-9
  - implicit, 5-9
- format, 5-3
  - character set, 5-3
- line lengths, 5-3
- minimal, 5-8, 5-9
- Object Description Language (ODL), 5-1
- object pointers, 5-12
  - attached label examples, 5-12
  - detached label examples, 5-14
- padding, 5-3
- pointers
  - to data objects, 5-12
  - to descriptive text, 5-17
  - to structure files, 5-17
- standard data objects, 5-17
- standards identifiers, 5-10
- structure
  - attached and detached, 5-4
  - combined detached, 5-6
  - minimal, 5-9
  - minimal example***, 5-10
  - structure pointers, 5-17
- Labels***
  - structure
    - attached/detached example, 5-5
- locally defined data elements, 5-19
  - control authority, 5-21
  - custodians, 5-21
  - examples, 5-19
  - identification of, 5-21
  - justification for, 5-19
  - namespace, 5-21
  - review and use, 5-21
  - scope of use, 5-19
- minimal label, 5-8
- minimal labels, 5-14
- Namespace
  - see locally defined data elements, 5-21
- object definitions

- format, 5-17
- Object Description Language (ODL), 5-1
- object pointers, 5-12
  - attached label examples, 5-12
  - formats, 5-12
  - syntax, 5-13
- PDS\_VERSION\_ID, 5-10
- Planetary Science Data Dictionary* (PSDD), 5-1, 5-15, 5-17
- pointers
  - structure pointers, 5-17
  - to descriptive text, 5-17
- RECORD\_BYTES, 5-11
- RECORD\_TYPE, 5-11
- Standard Formatted Data Unit (SFDU), 5-11, 5-18
- standards identifier data elements, 5-10

# Chapter 6. Data Set / Data Set Collection Contents and Naming

The Data Set / Data Set Collection Contents and Naming standard defines the conventions for maintaining consistency in the contents, organization and naming of archive quality data sets .

Data Sets are defined in terms of Data Products, which were introduced in Chapter 4. A data set is an aggregation of data products with a common origin, history, or application. A data set includes primary (observational) data plus the ancillary data, software, and documentation needed to understand and use the observations. Files in a data set share a unique data set name, share a unique data set identifier, and are described by a single DATA\_SET catalog object (or equivalent).

Data Set Collections are defined in terms of data sets. A data set collection is an aggregation of several data sets that are related by observation type, discipline, target, or time which are to be treated as a unit; that is, they are intended to be archived and distributed together. Data sets in a data set collection share a unique data set collection name, share a unique data set collection identifier, and are described by a single DATA\_SET\_COLLECTION object (or equivalent). One of the primary considerations in creating a data set collection is that the collection as a whole provides more utility than the sum of the utilities of the individual data sets.

Figure 6.1 shows the relationships among Data Products, Data Sets, and a Data Set Collection.

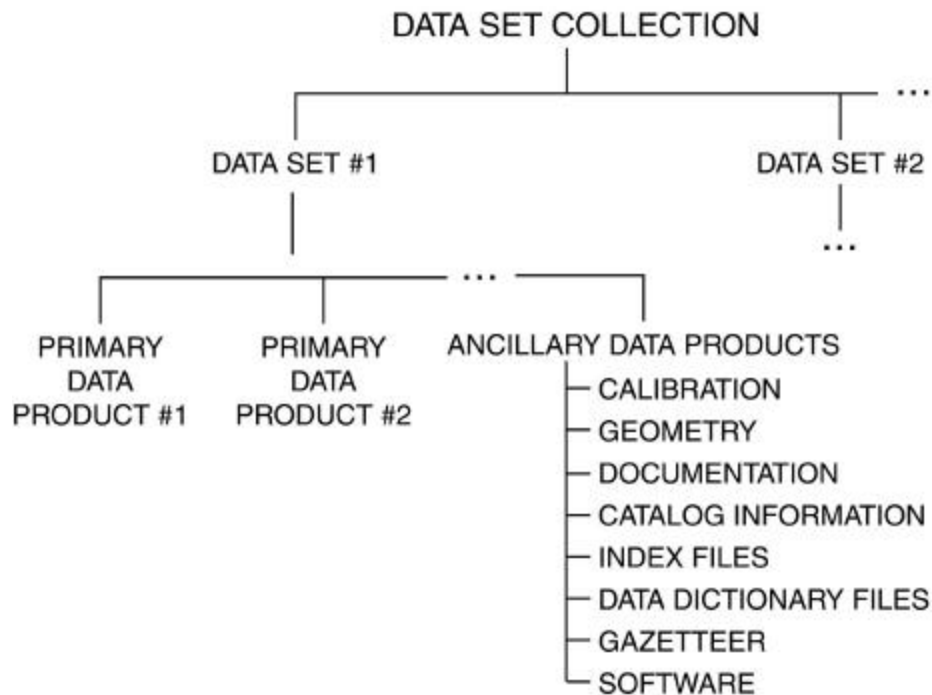

**Figure 6.1 Relationships among a Data Set Collection, its Data Sets, and their Data Products.**

Note that with respect to Figure 6.1, additional data sets (e.g., Data Set #2) have structure similar to Data Set #1. And, Ancillary Data Products are often organized into directories corresponding to the subject areas shown (see Chapter 19 for a more detailed description of each directory).

Ancillary Data Products may include any or all of the following:

**Calibration** - Data products used in the conversion of raw measurements to physically meaningful values or data products needed to use the data.

**Geometry** - Data products needed to describe the observing geometry. Examples include SEDRs and SPICE files.

**Documentation** - Data products which describe the mission, spacecraft, instrument, and/or data set. These may include references to science papers or the papers themselves.

**Catalog Information** - Descriptive information about a data set expressed in Object Description Language (ODL) and suitable for loading into a catalog. For more information, see Appendix B.

**Index Files** - Information that allows a user to locate the data of interest - a table of contents. An example might be a table mapping latitude/longitude ranges to file names.

**Data Dictionary Files** - An extract of the *Planetary Science Data Dictionary* (PSDD) that is pertinent to the data set and expressed in ODL.

**Gazetteer** - Information about the named features on a target body associated with the data set.

**Software** - Software libraries, utilities, and/or application programs to access/process the data products.

## 6.1 Data Set Naming and Identification

Each PDS data set must have a unique name (DATA\_SET\_NAME) and a unique identifier (DATA\_SET\_ID), both formed from up to seven components. The components are listed here; valid assignments for each component are described in Section 6.3:

- Instrument host
- Target
- Instrument
- Data processing level number
- Data set type (optional)
- Description (optional)

Version number

Multiple targets or data processing levels are referenced in the data set collection name or identifier by concatenation of the values with a forward slash (/) which is interpreted as "and."

## 6.3 Name and ID Components

### 6.3.1 Restrictions on DATA\_SET\_ID and DATA\_SET\_COLLECTION\_ID

Within the DATA\_SET\_ID and DATA\_SET\_COLLECTION\_ID, acronyms are separated by hyphens. The only characters allowed are:

- ?? Uppercase characters, A-Z
- ?? Digits, 0-9
- ?? The hyphen character, "-"
- ?? The forward slash, "/"
- ?? The period character, ".", but only as part of a numeric component (e.g., "V1.0" but not "C.A")

### 6.3.2 Standard Acronyms, Abbreviations, and Assignments

This section details the standard acronyms and abbreviations required for formulating the DATA\_SET\_ID and DATA\_SET\_COLLECTION\_ID values. They are also recommended for use, as appropriate, in the formation of other NAME - and ID-class element values. Standard values for data dictionary elements mentioned in the following sections are listed in the PSDD. New values are added to these lists as needed by the PDS data engineers.

1. **Instrument host** name and ID values are selected from the standard value list of the corresponding PSDD entry (INSTRUMENT\_HOST\_NAME or INSTRUMENT\_HOST\_ID data element). Note that the acronym EAR has been used for Earth-based data sets without a specific instrument host.
2. **Collection names and IDs** are created as needed by the data preparers in conjunction with the PDS data engineer. Current IDs and their corresponding names include:

GRSFE	Geological Remote Sensing Field Experiment
IHW	International Halley Watch
PREMGN	Pre-Magellan

3. **Target name** values are selected from the standard values listed in the PSDD for the TARGET\_NAME element. Target acronyms are selected from the following list:

<u>Target ID</u>	<u>Target Name</u>
------------------	--------------------

A	Asteroid
C	Comet
CAL	Calibration
D	Dust
E	Earth
H	Mercury
J	Jupiter
L	Moon
M	Mars
MET	Meteorite
N	Neptune
P	Pluto
R	Ring
S	

Ancillary Data:       ENG or ENGINEERING for engineering data sets  
                               SPICE for SPICE data sets  
                               GCM for Global Circulation Model data  
                               SEDR for supplemental EDR data  
                               POS for positional data

5. **Data processing level number** is the National Research Council (NRC) Committee on Data Management and Computation (CODMAC) data processing level number.

Normally a data set contains data of one processing level. PDS recommends that data of different processing levels be treated as different data sets. However, if it is not possible to separate the data, then a single data set with multiple processing levels will be accepted. Use the following guidelines when specifying the data processing level number component of the data set identifier and name:

- (a) the processing level number of the largest subset of data or
- (b) the highest processing level number if there is no predominant subset.

Level	Type	Data Processing Level Description
1	Raw Data	Telemetry data with data embedded.
2	Edited Data	Corrected for telemetry errors and split or decommutated into a data set for a given instrument. Sometimes called Experimental Data Record. Data are also tagged with time and location of acquisition. Corresponds to NASA Level 0 data.
3	Calibrated Data	Edited data that are still in units produced by instrument, but that have been corrected so that values are expressed in or are proportional to some physical unit such as radiance. No resampling, so edited data can be reconstructed. NASA Level 1A.
4	Resampled Data	Data that have been resampled in the time or space domains in such a way that the original edited data cannot be reconstructed. Could be calibrated in addition to being resampled. NASA Level 1B.
5	Derived Data	Derived results, as maps, reports, graphics, etc. NASA Levels 2 through 5.
6	Ancillary Data	Nonscience data needed to generate calibrated or resampled data sets. Consists of instrument gains, offsets, pointing information for scan platforms, etc.
7	Correlative Data	Other science data needed to interpret space-based data sets. May include ground-based data observations such as soil type or ocean buoy measurements of wind drift.
8	User Description	Description of why the data were required, any peculiarities associated with the data sets, and enough documentation to allow secondary user to extract information from the data.
N	N	Not Applicable



6. **Data set type** provides additional identification if, for example, the CODMAC data processing level component is not sufficient to identify the type or level of data. Following is a list of valid IDs and names that may be used for this component.

NOTE: Several of the values in this table are currently unique to a particular mission (e.g., BIDR and MIDR were used on Magellan). These values may be used on other missions, if deemed appropriate.

<u>ID</u>	<u>Name</u>
ADR	Analyzed Data Record
BIDR	Basic Image Data Record
CDR	Composite Data Record
CK	SPICE CK (Pointing Kernel)
DDR	Derived Data Record (possibly multiple instruments)
DIDR	Digitalized Image Data Record
DLC	Detailed Level Catalog
EDC	Existing Data Catalog
EDR	Experiment Data Record
EK	SPICE EK (Event Kernel)
GDR	Global Data Record
IDR	Intermediate Data Record
IK	SPICE IK (Instrument Kernel)
LSK	SPICE LSK (Leap Second Kernel)
MDR	Master Data Record
MIDR	Mosaicked Image Data Record
ODR	Original Data Record
PCK	SPICE PCK (Planetary Constants Kernel)
PGDR	Photograph Data Record
RDR	Reduced Data Record
REFDR	Reformatted Data Record
SDR	System Data Record
SEDR	Supplementary Experiment Data Record
SPK	SPICE SPK (Ephemeris Kernel)
SUMM	Summary (data) (to be used in the browse function)
SAMP	Sample data from a data set (not subsampled data)

7. **Description** is optional, but allows the data provider to describe the data set better – for example, to identify a specific comet or asteroid. Following is a list of example values (both IDs and names) that can be used for this component.

<u>ID</u>	<u>Name</u>
-----------	-------------

ALT/RAD	Altimetry and Radiometry
BR	Browse
CLOUD	Cloud
ELE	Electron
ETA-AQUAR	Eta-Aquarid Meteors
FULL-RES	Full Resolution
GIACOBIN-ZIN	Comet P/Giacobini-Zinner
HALLEY	Comet P/Halley
ION	Ion
LOS	Line of Sight Gravity
MOM	Moment
PAR	Parameter
SA	Spectrum Analyzer
SA-4.0SEC	Spectrum Analyzer 4.0 second
SA-48.0SEC	Spectrum Analyzer 48.0 second

8. **Version number** is determined as follows:

- (a) If there is not a previous version of the PDS data set/data set collection, then use Version 1.0.
- (b) If a previous version exists, then PDS recommends the following:
  - i. If the data sets/data set collections contain the same set of data, but use a different medium (e.g., CD-ROM), then no new version number is required (i.e., no new data set identifier). The inventory system will handle the different media for the same data set.
  - ii. If the data sets/data set collections contain the same set of data, but have minor corrections or improvements such as a change in descriptive labeling, then the version number is incremented by a tenth. For example, V1.0 becomes V1.1.
  - iii. If a data set/data set collection has been reprocessed, using, for example, a new processing algorithm or different calibration data, then the version number is incremented by one (V1.0 would become V2.0). Also, if one data set/data set collection contains a subset, is a proper subset, or is a superset of another, then the version number is incremented by one.

## 6.4 Examples

For a data set containing the first version of Mars Cloud Data derived from the Mariner 9, Viking Orbiter 1, and Viking Orbiter 2 imaging subsystems, the data set name and identifier would be :

```
DATA_SET_NAME = "MR9/V01/V02 MARS ISS/VIS 5 CLOUD V1.0"
```

```
DATA_SET_ID = "MR9/V01/V02 -M-ISS/VIS-5-CLOUD-V1.0"
```

In this example the optional data set type is not used. The other components are:

- ?? Instrument hosts are Mariner 9, Viking Orbiter 1 and Viking Orbiter 2
- ?? Target is Mars
- ?? Instruments are the Imaging Science Subsystem and Visual Imaging Subsystem
- ?? Data Processing Level number is 5
- ?? Description is CLOUD
- ?? Version number is V1.0

Note that the individual components in the DATA\_SET\_ID closely match the corresponding components used in the DATA\_SET\_NAME.

The Pre-Magellan Data Set Collection contains radar and gravity data similar to the kinds of data that Magellan collected and was used for pre-Magellan analyses of Venus and for comparisons to actual Magellan data. In conversation the data set might be described as Pre -Magellan Earth, Moon, Mercury, Mars, and Venus Resampled and Derived Radar and Gravity Data Version 1.0. The data set collection name and ID were :

:

```
DATA_SET_COLLECTION_NAME = "PRE -MAGELLAN E/L/H/M/V 4/5 RADAR/GRAVITY  
DATA V1.0"
```

```
DATA_SET_COLLECTION_ID = "PREMGN -E/L/H/M/V-4/5-RAD/GRAV-V1.0"
```

<b>A</b>
----------

ancillary data product	
contents.....	6-2
contents (diagram) .....	6-2
archive quality	
data set.....	6-1
data set collection.....	6-1

<b>C</b>
----------

calibration data .....	6-2
catalog information .....	6-2
CODMAC numbers .....	<i>See data processing level</i>

<b>D</b>
----------

data dictionary files.....	6-3
data processing level .....	6-7
CODMAC numbers .....	6-6
data product	
relation to data set.....	6-1
relation to data set collection .....	6-1
data set	
contents.....	6-1
definition .....	6-1
naming and identification .....	6-3
processing level.....	6-7
relation to data products.....	6-1
reprocessed, version number .....	6-9
data set collection	
contents.....	6-1
contents (diagram) .....	6-2
definition .....	6-1
naming and identification .....	6-4
relation to data products.....	6-1
reprocessed, version number .....	6-9
data set description	
acronyms .....	6-8
data set type	
acronyms .....	6-7
DATA_SET_COLLECTION_ID	
constituent components.....	6-4
data set type.....	6-7
description .....	6-8

example .....	6-10
standard acronyms and abbreviations .....	6-5
syntax .....	6-4
version number .....	6-9
<b>DATA_SET_COLLECTION_NAME</b>	
constituent components .....	6-4
example .....	6-10
<b>DATA_SET_ID</b>	
constituent components .....	6-3
data set type .....	6-7
description .....	6-8
example .....	6-9
satellite and ring names in .....	6-6
standard acronyms and abbreviations .....	6-5
syntax .....	6-4
version number .....	6-9
<b>DATA_SET_NAME</b>	
constituent components .....	6-3
example .....	6-9
satellite and ring names in .....	6-6
documentation .....	6-2

<b>G</b>
----------

gazetteer data .....	6-3
geometry data .....	6-2

<b>I</b>
----------

index files .....	6-3
-------------------	-----

<b>P</b>
----------

processing level number .....	<i>See data processing level</i>
-------------------------------	----------------------------------

<b>S</b>
----------

software files .....	6-3
----------------------	-----

<b>T</b>
----------

target	
acronyms .....	6-5
<b>TARGET_NAME</b>	
acronym list .....	6-5



version number .....6-9

# Chapter 7. Date/Time Format

PDS has adopted a subset of the International Standards Organization Standard (ISO/DIS) 8601 standard entitled “Data Element and Interchange Formats - Representations of Dates and Times”, and applies the standard across all disciplines in order to give the system generality. See also Dates and Times in *Object Description Language* (Chapter 12, Section 12.3.2) of this document.

It is important to note that the ISO/DIS 8601 standard covers only ASCII representations of dates and times.

## 7.1 Date/Times

In the PDS there are two recognized date/time formats:

CCYY-MM-DDTHH:MM:SS.sssZ (preferred format)  
CCYY-DDDTHH:MM:SS.sssZ

Each format represents a concatenation of the conventional date and time expressions with the two parts separated by the letter T:

CC	-	century (00-99)
YY	-	year (00-99)
MM	-	month (01-12)
DD	-	day of month (01-31)
DDD	-	day of year (001-366)
T	-	date/time separator
HH	-	hour (00-23)
MM	-	minute (00-59)
SS	-	second (00-59)
sss	-	fractions of second (000-999)

The time part of the expression represents time in Universal Time Coordinated (UTC), hence the Z at the end of the expression (see Section 7.3.1 for further discussion). Note that in both the PDS catalog files and data product labels the “Z” is optional and is assumed.

*PDS standard date/time format*, i.e., the preferred date/time format, is: CCYY-MM-DDTHH:MM:SS.sssZ.

### ***Date/Time Precision***

The above date/time formats may be truncated on the right to match the precision of the date/time value in any of the following forms:

1998  
1998-12  
1998-12-01  
1998-12-01T23  
1998-12-01T23:59  
1998-12-01T23:59:58  
1998-12-01T23:59:58.1

### ***ODL Date/Time Information***

Chapter 12, *Object Description Language (ODL) Specification and Usage*, Section 12.3.2, **Dates and Times**, of this document provides additional information on the use of ODL in date/time formation, representation, and implementation.

## **7.2 Dates**

The PDS allows dates to be expressed in conventional and native (alternate) formats.

### **7.2.1 Conventional Dates**

Conventional dates are represented in ISO/DIS 8601 format as either year (including century), month, day-of-month (CCYY-MM-DD), or as year, day-of-year (CCYY-DDD). The hyphen character ('-') is used as the field separator in this format. The former is the preferred format for use in PDS labels and catalog files and is referred to as *PDS standard date format*, but either format is acceptable.

### **7.2.2 Native Dates**

Dates in any format other than the ISO/DIS 8601 format described above are considered to be in a format native to the specific data set, thus “native dates”. Native date formats are specified by the data preparer in conjunction with the PDS data engineer. Mission-elapsed days and time-to-encounter are both examples of native dates.

## **7.3 Times**

The PDS allows times to be expressed in conventional and native (alternate) formats.

### **7.3.1 Conventional Times**

Conventional times are represented as hours, minutes and seconds according to the ISO/DIS 8601 time format standard: HH:MM:SS[.sss]. Note that the hours, minutes, and integral seconds fields must contain two digits. The colon (':') is used as a field separator. Fractional seconds consisting of a decimal point (the European-style comma may not be used) and up to three digits (thousandths of a second) may be included if appropriate.

Coordinated Universal Time (UTC) is the PDS time standard and must be formatted in the



previously described ISO/DIS 8601 standard format. The letter "Z", indicating the civil time zone at Greenwich (i.e., GMT), may be appended to the time if desired and appropriate. Note that the relationship between UTC and GMT has varied historically and with observer context. UTC is the PDS time standard; a time with an appended 'Z' will be interpreted within the PDS as UTC, regardless of any changes or local variations in the GMT/UTC relationship.

The `START_TIME` and `STOP_TIME` data elements required in data product labels and catalog templates use the UTC format. For data collected by spacecraft-mounted instruments, the date/time must be a time that corresponds to “spacecraft event time”. For data collected by instruments not located on a spacecraft, this time shall be an earth-based event time value.

Adoption of UTC (rather than spacecraft-clock-count, for example) as the standard facilitates comparison of data from a particular spacecraft or ground-based facility with data from other sources.

### 7.3.2 Native Times

Times in any format other than the ISO/DIS 8601 format described above are considered to be in a format native to the data set, and thus “native times”. The `NATIVE_START_TIME` and `NATIVE_STOP_TIME` elements hold the native time equivalents of the UTC values in `START_TIME` and `STOP_TIME`, respectively.

There is one native time of particular interest, however, which has specific keywords associated with it. The spacecraft clock reading (that is, the “count”) often provides the essential timing information for a space-based observation. Therefore, the elements `SPACECRAFT_CLOCK_START_COUNT` and `SPACECRAFT_CLOCK_STOP_COUNT` are required in labels describing space-based data. This value is formatted as a string to preserve precision.

Note that in rare cases in which there is more than one native time relevant to an observation, the data preparer should consult a PDS data engineer for assistance in selecting the appropriate PDS elements.

The following paragraphs describe typical examples of native time formats.

1. **Spacecraft Clock Count (sclk)** - Spacecraft clock count (sclk) provides a more precise time representation than event time for instrument-generated data sets, and so may be desirable as an additional time field. In a typical instance, a range of spacecraft-clock-count values (i.e., a start-and a stop-value) may be required.

Spacecraft clock count (`SPACECRAFT_CLOCK_START_COUNT` and `SPACECRAFT_CLOCK_STOP_COUNT`) shall be represented as a right-justified character string field with a maximum length of thirty characters. This format will accommodate the extra decimal point appearing in these data for certain spacecraft and other special formats, while also supporting the need for simple comparison (e.g., “>” or “<”) between clock count values.

Note that if the spacecraft clock values are not strictly numeric strings (for example, if they contain colon separators), care should be taken in dealing with blank padding and justification of the string value. If necessary, non-numeric strings may be left-justified to ensure that clock values will sort in the expected way.

***Example***

```
SPACECRAFT_CLOCK_START_COUNT = " 1234:36.401"           correct
SPACECRAFT_CLOCK_START_COUNT = "1234:36.401  "         incorrect
```

2. **Longitude of Sun** - Longitude of Sun (“L<sub>s</sub>”) is a derived data value that can be computed, for a given target, from UTC.
3. **Ephemeris Time** - Ephemeris time (ET) is calculated as “TAI + 32.184 sec. + periodic terms”. The NAIF S and P kernels have data that are in ET, but the user (via NAIF ephemeris readers which perform data conversion) can obtain the UTC values.
4. **Relative Time** - In addition to event times, certain “relative time” fields will be needed to represent data times or elapsed times. Time-from-closest-approach is an example of such a data element. These times shall be presented in a (D,H,M,S) format as a floating point number, and should include fractional seconds when necessary. The inclusion of “day” in relative times is motivated by the possible multi-day length of some delta times, as could occur, for example, in the case of the several-month Galileo Jupiter orbit.
5. **Local Times** - For a given celestial body, LOCAL\_TIME is the hour relative to midnight in units of 1/24th the length of the solar day for the body.
6. **Alternate Time Zones (Relative to UTC)** - When times must be expressed according to an alternate time zone, they shall consist of hours, minutes, seconds, and an offset, in the form HH:MM:SS.sss+n, where n is the number of hours from UTC.

Note that only the Greenwich time zone may be indicated by its letter designator ("Z"); all other zones must be indicated by the hour offset from UTC.

- alternate time zone, 7-5
- date format
  - conventional, 7-2
  - native, 7-2
  - precision, 7-1
  - syntax, 7-1
- Ephemeris time (ET), 7-4
- local time, 7-4
- LOCAL\_TIME, 7-4
- native time
  - examples, 7-3
- relative time, 7-4
- slk. *See* spacecraft clock count (slk)
- spacecraft clock count (slk), 7-3
  - syntax, 7-4
- SPACECRAFT\_CLOCK\_START\_COUNT, 7-3, 7-4
- SPACECRAFT\_CLOCK\_STOP\_COUNT, 7-3, 7-4
- START\_TIME, 7-3
- STOP\_TIME, 7-3
- time format
  - conventional, 7-2
  - native, 7-3
  - PDS standard time format, 7-3
  - precision, 7-1
  - syntax, 7-1
- Universal Time Coordinated (UTC). *See* time format
  - date/time formats, use in
    - UTC, use of, 7-5
  - in labels and catalog files, 7-3

# Chapter 8. Directory Types and Naming

The Directory Naming standard defines the conventions for naming directories on a data volume. This chapter lists the standard directories established by PDS, plus the rules for forming subdirectory names and abbreviations.

## 8.1 Standard Directory Names

When any of the following directories are included on an archive product, the following standard directory naming conventions are used.

<i>Directory</i>	<i>Contents</i>
<b>CATALOG</b>	PDS catalog files
<b>DOCUMENT</b>	Documentation, supplementary and ancillary information to assist in understanding and using the data products
<b>EXTRAS</b>	“Value added” elements included by the data preparer, but outside the scope of the PDS archive requirements
<b>GAZETTER</b>	Tables of information about the geological features of a target
<b>INDEX</b>	Indices to assist in locating data of interest
<b>LABEL</b>	“Include” files which describe specific aspects of the data format and organization
<b>SOFTWARE</b>	Utilities, application programs, or subprograms used to access or process the data

The following standard directory names are recommended for use on archive volumes. Note that these directory names are reserved for the uses described below. That is, if they appear on an archive volume, they must contain the indicated information:

<b>CALIB</b>	Calibration files used in the original processing of the data, or needed to use the data
<b>GEOMETRY</b>	Files describing the observational geometry (e.g., SEDRs, SPICE kernels)
<b>BROWSE</b>	Reduced resolution versions of data products
<b>DATA</b>	Contains one or more subdirectories of data products. The DATA subdirectory is used to unclutter the root directory of a volume by providing a single entry point to multiple data subdirectories.

Note that some data sets may not contain all the components above and, as a result, do not need all of the directories listed. For example, many image data sets do not include geometry files and so do not need a GEOMETRY directory. See the *Volume Organization and Naming* chapter of this document for a list of required and optional subdirectories on any specific volume.

## 8.2 Formation of Directory Names

1. A directory name must consist of only uppercase alphanumeric characters and the underscore character (i.e., A-Z, 0-9, or “\_”). No lowercase letters (i.e., a-z) or special characters (e.g., “#”, “&”, “\*”) are allowed.
2. A directory name must not exceed 31 characters in length, to comply with the ISO 9660 level 2 media interchange standard.
3. The first letter of a directory name must be an alphabetic character, unless the directory name represents a year (e.g., 1984).
4. If numeric characters are used as part of the name (e.g., DIR1, DIR2, DIR3) the numeric part should be padded with leading zeros up to the maximum size of the numeric (DIR0001, DIR0002, DIR3267).
5. Directories which contain a range of similarly named files must be assigned directory names using the portion of the filename which encompasses all the files in the directory, with “X’s” used to indicate the range of values of actual filenames in the directory.  
  
For example, the PDS Uranus Imaging CD-ROM disk contains image files that have filenames that correspond to SPACECRAFT\_CLOCK\_START\_COUNT values. The directory that contains the image files ranging from C2674702.IMG through C2674959.IMG has the directory name C2674XXX.
6. Directory names must use full length terms whenever possible (e.g., SATURN, MAGELLAN, CRUISE, NORTH, DATA, SOFTWARE). Otherwise, directory names must be constructed from abbreviations of full-length names using the underscore character to separate abbreviated terms, if possible. The meaning of the directory name should be clear from the abbreviation and from the directory structure.

For example, the following directory structure can be found on the Voyager 2 Images of Uranus CD-ROM Volume 1:

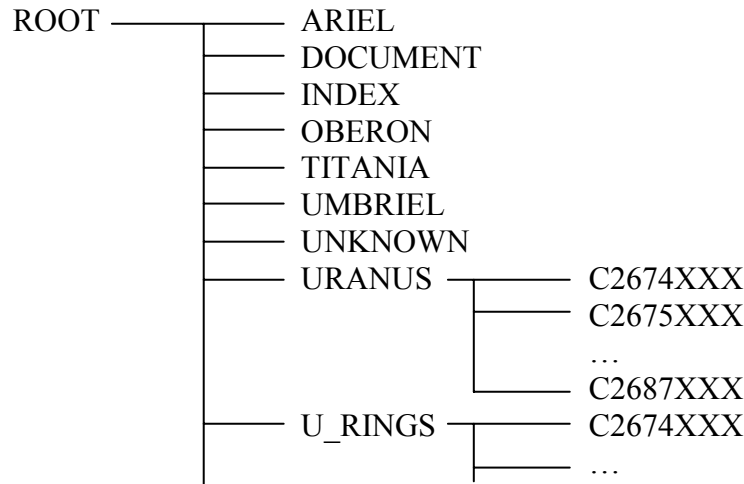

In this case, it is clear from the context that the directory U\_RINGS is the abbreviated form of URANUS\_RINGS.

- High level directories that deal with data sets covering a range of planetary science disciplines or targets shall adhere to the following hierarchy:

A Planetary science directory:	PLANET
Planetary body subdirectories:	MERCURY, MOON, MARS, VENUS, COMET
Discipline subdirectories:	ATMOS, IONOSPHE, MAGNETOS, RING, SURFACE, and SATELLIT (Use satellite name if numerous files exist)

- The recommended SOFTWARE subdirectory naming convention is described in the *Volume Organization and Naming* chapter of this document. Either a platform-based model or an application-based model can be used in defining software subdirectories. In a platform-based model, the hardware platform, operating system and environment must be explicitly stated. If there is more than one operating system/environment supported they are addressed as subdirectories under the hardware directories. When there is only one, the subdirectory may be promoted to the hardware directory.

For example, if software for the PC for both DOS and Windows were present on the volume, the directories SOFTWARE/PC/DOS and SOFTWARE/PC/WIN would exist. If only DOS software were present, the directory would be SOFTWARE/PCDOS.

### 8.3 Path Formation Standard

The PDS standard for path names is based on Level 1 of the ISO 9660 international standard. A pathname may consist of up to eight directory levels. Each directory name is limited to eight characters; the forward-slash character (“/”) is used as the separator in path names. Path names typically appear on PDS volumes as data in index tables for locating specific files on an archive volume. They may also appear as values in a limited number of keywords (e.g., FILE\_SPECIFICATION\_NAME, PATH\_NAME, and LOGICAL\_VOLUME\_PATH\_NAME).

The following are examples of valid values for the keywords listed above:

TG15NXXX/TG15N1XX/TG15N12X	identifies the location of the directory TG15N12X at the third level below the top level of an archive volume.
DOCUMENT	identifies a DOCUMENT directory within the root directory.

Note: The leading slash is omitted because these are relative paths. The trailing slash is included so that concatenation of PATH\_NAME and FILE\_NAME will yield the full file specification. See the *File Specification and Naming* chapter of this document for more information.

Previous PDS standards allowed the use of the DEC VMS syntax for path names. While PDS support for this format continues to exist, it is recommended that all future volumes use the UNIX syntax instead.

### 8.4 Tape Volumes

When magnetic tape is the archive medium, a disk directory structure cannot be used because the medium does not support multi-level directories. In this case, files must be stored sequentially.

A directory structure for the volume must be designed in any case, so that when the data are transferred to a medium that supports hierarchical file management they can be placed into an appropriate directory structure. A DIRECTORY object must be included with each tape volume within the VOLUME object. This object is then used to describe how the sequential files should be loaded into a hierarchical structure.

### 8.5 Exceptions to These Standards

In certain cases, the archive medium used to store the data, the hardware used to produce the data set, or the software operating on the data may impose restrictions on directory names and organization. In these cases, consult a PDS data engineer for guidance in designing the archive volume structure.

directories

path names, 8-4

reserved names, 8-1

standard directories, 8-1

DIRECTORY, 8-4

directory names

and ISO 9660, 8-2

syntax, 8-2

directory naming, 8-1

directory paths

and ISO 9660, 8-4

syntax, 8-4

directory structure

example, 8-3

on sequential media, 8-4

tape volumes, 8-4

VOLUME, 8-4



# Chapter 9. Documents

Supplementary or ancillary reference materials are usually included with archive products to improve their short- and long-term utility. These documents augment the internal documentation of the product labels and provide further assistance in understanding the data products and accompanying materials. Typical archive documents include:

- ?? Flight project documents
- ?? Instrument papers
- ?? Science articles
- ?? Volume information
- ?? Software Interface Specifications (SISs)
- ?? Software user manuals

The PDS criteria for inclusion of a document in the archive are:

1. Would this information be helpful to a data user?
2. Is the material necessary?
3. Is the documentation complete?

In general, the PDS seeks to err on the side of completeness.

Each document to be archived must be prepared and saved in a PDS -compliant format, including a PDS label. Documents are delivered in the DOCUMENT directory of an archive volume (see the *Volume Organization and Naming* chapter of this document).

A flat, human -readable ASCII text version of each document must be included on the volume, although additional versions may be included in other supported formats at the option of the data producer. “Flat ASCII text” means the file may contain only the standard, 7 -bit printable ASCII character set, plus the blank character and the carriage -return and linefeed characters as record delimiters. A file is “human -readable” if it is not encoded and if any special markup tags which may be included do not significantly interfere with an average user’s ability to read the file. So, for example, simple HTML files and TeX/LaTeX files with relatively little markup embedded in the text are generally considered human -readable and may, therefore, be used to satisfy the above ASCII text version requirement.

Note that the PDS takes the requirement for complete documentation very seriously. Documents that are essential to the understanding of an archive are considered as important as the data files themselves. Furthermore, including a document in a PDS archive constitutes publication (or re - publication) of that document. Consequently, documents prepared for inclusion in an archive are expected to meet not only the PDS label and format requirements, but also the structural, grammatical and lexical requirements of a refereed journal submission. Documents submitted for archiving which contain spelling errors, poor grammar or illogical organization will be rejected and may ultimately lead to the rejection of the submitted data for lack of adequate documentation.

## 9.1 PDS Objects for Documents

PDS labels of documentation files use either the TEXT or DOCUMENT object, as appropriate. The DOCUMENT object is usually used with documentation files found in the DOCUMENT directory of an archive volume. Files described by a DOCUMENT object may be in any of the formats described in Section 9.2.

The TEXT object may only be used with ASCII text files containing no markup. TEXT objects are most often used for small text files occurring anywhere in the archive volume (for example, the AAREADME.TXT file in the root directory or the DOCINFO.TXT file in the DOCUMENT directory).

### 9.1.1 TEXT Objects

TEXT objects are preferred for stand-alone documents with a narrow focus. For example, the AAREADME.TXT or DOCINFO.TXT files on the archive volume are usually labeled using a TEXT object. Files described by a TEXT object must:

- a) Be plain, flat ASCII files without markup tags (i.e., no HTML or TeX files), encoded graphics (as in PostScript files), or programmatic structures (i.e., no source code files or scripting commands); and
- b) Have a file extension of “.TXT”

### 9.1.2 DOCUMENT Objects

DOCUMENT objects are preferred when several versions of the same file are provided or when there are several component files constituting a single version of the document - for example, when graphics are included in separate files from the text. Any file labeled using a DOCUMENT object must:

- a) Be in one of the PDS-approved formats listed below; and
- b) Use the appropriate object characteristics (listed below) for the DOCUMENT object parameters and the file extension.

DOCUMENT labels are most often combined detached labels, since attaching them to most of the formats listed below would make the combined file unusable in its customary environment (Microsoft *Word*, for example, cannot recognize “.DOC” files with attached PDS labels).

Format	Object	Interchange Format	Document Format	File Extension
Plain ASCII Text	ASCII_DOCUMENT	ASCII	TEXT	.ASC
HTML	HTML_DOCUMENT	ASCII	HTML	.HTM or .HTML*
TeX	TEX_DOCUMENT	ASCII	TEX	.TEX
LaTeX	LATEX_DOCUMENT	ASCII	LATEX	.TEX
Adobe PDF	PDF_DOCUMENT	BINARY	ADOBE PDF	.PDF
MS Word	WORD_DOCUMENT	BINARY	MICROSOFT WORD	.DOC
Rich Text	RTF_DOCUMENT	BINARY	RICH TEXT	.RTF
GIF	GIF_DOCUMENT	BINARY	GIF	.GIF
JPG	JPG_DOCUMENT	BINARY	JPG	.JPG
Encapsulated Postscript	EPS_DOCUMENT	BINARY	ENCAPSULATED POSTSCRIPT	.EPS
PNG	PNG_DOCUMENT	BINARY	PNG	.PNG
Postscript	PS_DOCUMENT	BINARY	POSTSCRIPT	.PS
Tagged Image File Format	TIFF_DOCUMENT	BINARY	TIFF	.TIF or .TIFF*

\* See chapter *File Specification and Naming* regarding extensions with more than three characters.

Example: “MYDOC” is a document file to be included in the DOCUMENT directory of an archive volume. Two versions will be supplied: a flat ASCII version with the graphics in separate TIFF files; and a Microsoft Word version with in-line graphics in a single file. In the PDS label, “MYDOC” will be described using a DOCUMENT object for each different file format provided. The files included in the directory will be:

1. MYDOC.ASC            required ASCII version
2. MYDOC.DOC           optional Microsoft Word version to retain all graphics
3. MYDOC001.TIF        optional scanned TIFF version of selected pages
4. MYDOC002.TIF        optional scanned TIFF version of other selected pages
5. MYDOC.LBL            PDS label defining DOCUMENT object(s) for these files

Optional versions of the document should have the same file name as the required ASCII version but with different extensions. Optional versions should be defined as additional DOCUMENT objects in the single PDS label; the name of the required ASCII file should be indicated in the text of the DESCRIPTION keyword.

## 9.2 Document Format Details

### 9.2.1 Flat ASCII Text

**Line Length and Delimiters** - PDS recommends plain text files have line length restricted to 78 characters or fewer, to accommodate printing and display on standard devices. Each line must be terminated by the two-character carriage-return/linefeed sequence (ASCII decimal character codes 13 and 10, respectively).

**Page Length and Breaks** - Block paragraph style is preferred, with paragraphs being separated by at least one blank line. The form feed character (ASCII decimal code 12) may be used to indicate page breaks, in which case pages should contain no more than 60 lines of text. A formfeed character should be inserted immediately after the END statement line of an attached PDS label in these files.

## 9.2.2 ASCII Text Containing Markup Language

**Line Length and Delimiters** - The 78-character line length recommendation is dropped for these files. Notwithstanding, the lines must be delimited by the carriage return/linefeed character combination.

**Page Length and Breaks** - Page breaks are controlled by the markup in these files. Consequently, there are no specific page length recommendations.

Note: ASCII files containing extensive markup may not pass the “human -readable” test. Also, some automatic converters producing, for example, HTML files that might be expected to be human-readable in fact add so many additional marks and notations that those files also fail the “human-readable” test. Consult a PDS data engineer for help in determining whether a particular file can be considered “human -readable” for archive purposes.

### 9.2.2.1 Hyper-Text Markup Language (HTML) Files

PDS archive products must adhere to Version 3.2 of the HTML language, a standard generalized markup language (SGML) conforming to the ISO 8879 standard. All files are subject to validation against the HTML 3.2 SGML Declaration and the HTML Document Type Definition.

Note: Constructs not defined in the HTML 3.2 standard (e.g., FRAME, STYLE, SCRIPT, and FONT FACE tags) are not allowed in PDS documentation files.

### 9.2.2.2 Location of Files

PDS strongly recommends that targets of all HTML links be present on the archive volume. In cases where external links are provided, the link should lead to supplementary information that is not essential to understanding or use of the archival data.

PDS recommends that all files comprising an HTML document or series of documents be located in a single directory. However, locating ancillary files (e.g., images, common files) in subdirectories may be required under certain circumstances (e.g., to avoid conflicts in file names or to minimize replication of common files).

### 9.2.2.3 Discouraged HTML 3.2 Capabilities

Although the APPLET tag is advertised to be supported by all Java enabled browsers, not all

applets execute on all browsers on all platforms. Further, some browsers require that the user explicitly enable use of Java applets before the applet will execute. Consequently, applets are permitted in PDS document files only when the information they convey is not essential to understanding or use of the archival data.

Use of the TAB character is permitted but strongly discouraged because of variations in implementation among browsers and resulting misalignments within documents.

Use of animated GIF image files is discouraged.

### 9.2.3 Non-ASCII Formats

Wherever possible the specific encoding and version level information should be included in the label for all non-ASCII documents. The ENCODING\_TYPE keyword is used to indicate the base encoding type (e.g., PostScript, GIF, etc.), while the specific version information should be included in the text of the DESCRIPTION keyword. See the PSDD for a list of standard encoding types. Additional types may be added at the discretion of the PDS data engineer.

### 9.2.4 Validation

Documentation files prepared to accompany a data set or data set collection must be validated. Validation consists of checking to ensure that the files can be copied or transmitted electronically, and can be read or printed by their target text-processing program. Documentation files should be spell-checked prior to being submitted to PDS for validation.

## 9.3 Examples

### 9.3.1 Simple Example of Attached label (Plain ASCII Text)

The following label could be attached to a plain ASCII text file describing the content and format of Mars Pathfinder Imager Experiment Data Records.

```
PDS_VERSION_ID      = PDS3
RECORD_TYPE         = STREAM
OBJECT              = TEXT
NOTE                = "Mars Pathfinder Imager Experiment Data Record SIS"
PUBLICATION_DATE    = 1998-06-30
END_OBJECT          = TEXT
END
```

### 9.3.2 Complex Example of Detached Label (Two Document Versions)

If the data producer chose to provide the same document in both plain ASCII text and as a Microsoft Word document, the detached label would have the name EDRSIS.LBL and would be as follows:



```
END_OBJECT          = HTML_DOCUMENT

OBJECT              = PDF_DOCUMENT
DOCUMENT_NAME       = "Mars Pathfinder Imager Experiment Data
                    Record"
PUBLICATION_DATE    = 1998-06-30
DOCUMENT_TOPIC_TYPE = "DATA PRODUCT SIS"
ENCODING_TYPE       = "PDS-ADOBE-1.1"
INTERCHANGE_FORMAT  = BINARY
DOCUMENT_FORMAT     = "ADOBE PDF"
DESCRIPTION         = "This document contains a description
                    of the VICAR and PDS formatted Mars
                    Pathfinder IMP Experiment Data Records. This
                    is a PDF version of the document."

END_OBJECT          = PDF_DOCUMENT

OBJECT              = PNG_DOCUMENT
DOCUMENT_NAME       = "Mars Pathfinder Imager Experiment Data
                    Record"
PUBLICATION_DATE    = 1998-06-30
DOCUMENT_TOPIC_TYPE = "DATA PRODUCT SIS"
FILES               = 4
ENCODING_TYPE       = "PNG1.0"
INTERCHANGE_FORMAT  = BINARY
DOCUMENT_FORMAT     = PNG
DESCRIPTION         = "This document is a PNG representation of two
                    figures and two tables from the Mars
                    Pathfinder IMP Experiment Data Record SIS."

END_OBJECT          = PNG_DOCUMENT
END
```

- AAREADME.TXT, 9-2
- ASCII files
  - containing markup, 9 -4
  - format, 9-3
- DOCINFO.TXT, 9-2
- DOCUMENT, 9-2
- DOCUMENT objects, 9-2
- documentation, 9-1
  - ASCII file format, 9-3
  - criteria for inclusion, 9 -1
  - example
    - attached TEXT, 9-5
    - detached, 9-5
    - with graphics, 9 -6
  - format, 9-1
  - HTML, 9-1, 9-4
  - labels for, 9-2
  - markup files, 9 -4
  - non-ASCII files, 9-5
  - required ASCII format, 9-1
  - TeX/LaTeX, 9-1
  - validation, 9 -5
- ENCODING\_TYPE, 9-5
- extensions
  - table of, 9-3
- TEXT, 9-2
- TEXT objects, 9-2



# Chapter 10. File Specification and Naming

The *File Specification and Naming* standard defines the PDS conventions for forming file specifications and names. This chapter is based on levels 1 and 2 of the international standard ISO 9660, "Information Processing - Volume and File Structure of CD-ROM for Information Interchange."

## ***ISO 9660 Level 1 versus ISO 9660 Level 2***

PDS recommends that archive products adhere to the ISO 9660 Level 1 specification. Specifically, CD-ROM volumes that are expected to be widely distributed should use file identifiers consisting of a maximum of eight characters in the base name and three characters in the extension (i.e., "8.3" file names).

When there are compelling reasons to relax the 8.3 file name standard, the ISO 9660 Level 2 specification with respect to file names *only* may be used, subject to the restrictions listed in Section 10.1.2.

## **10.1 File Specification Standards**

A file specification consists of the following elements:

1. A complete directory path name (as discussed in the *Directory Types and Naming* chapter of this document)
2. A file name (including extension)

The PDS has adopted the UNIX/POSIX forward slash character (/) as the directory separator for use in path names. Directory path name formation is discussed further in the *Directory Types and Naming* chapter of this document.

The following is an example of a simple file specification. The file specification identifies the location of the file relative to the root of a volume, including the directory path name.

File Name: TG15N122.IMG

File Specification: TG15NXXX/TG15N1XX/TG15N12X/TG15N122.IMG

Do not use path or file names that correspond to operating system specific names, such as:

AUX COM1 CON LPT1 NUL PRN

### 10.1.1 ISO 9660 Level 1 Specification

A file name consists of a base name and an extension, separated by a full stop character (“.”). Under ISO 9660 Level 1, the length of the base name may not exceed eight characters and the extension may not exceed three characters. In addition, a version number consisting of a semicolon and an integer must follow the file identifier. The base name and extension may only contain characters from the following set: the upper case alphanumeric characters (A- Z, 0-9) and the underscore (“\_”). Collectively, these requirements are often referred to as the “8.3” (“8 dot 3”) file naming convention. These limitations exist primarily to accommodate older computer systems that cannot handle longer file names. Since PDS archive volumes are designed to be read on many platforms, including PCs, these restrictions are necessary.

Preferred format: BASENAME (1..8 characters) "." EXTENSION (3 characters)

Allowable format: BASENAME (1..8 characters) "." EXTENSION (1..3 characters)

Actual format

on archive medium: BASENAME (1..8 characters) "." EXTENSION (1..3 characters) ";1"

### 10.1.2 ISO 9660 Level 2 Specification

The PDS use of ISO 9660 Level 2 file names adheres to all the above restrictions, with one exception: the base name may be up to 27 characters long (total file name length not to exceed 31 characters). Thus, this format is sometimes referred to as the “27.3” format.

*Note:* In rare cases the following variations are allowed on the 27.3 format file name:

- The file name portion may be up to 29 characters long; or
- The extension may be up to 29 characters long.

In no case, however, may the total file name length, including the “.”, exceed 31 characters.

Preferred format: BASENAME (1..27 characters) "." EXTENSION (3 characters)

Allowable format: BASENAME (1..29 characters) "." EXTENSION (1..29 characters)

Actual format

on archive medium: BASENAME (1..29 characters) "." EXTENSION (1..29 characters) ";1"

Note that *only* the file name specification for Level 2 may be used in PDS archive volumes. All other Level 2 extensions are prohibited.

## 10.2 Reserved Directory Names, File Names and Extensions

A number of file names, directory names and file extensions are reserved for files that are required in PDS archive volumes under various circumstances. These reserved names and extensions are listed in the following sections for easy reference. For details concerning what directories and files are required where and when, see the indicated chapter.

### 10.2.1 Reserved Directory Names

The following directory names are reserved. The contents of these directories are described in Chapter 19, *Volume Organization and Naming*.

BROWSE  
 CALIB  
 CATALOG  
 DATA  
 DOCUMENT  
 EXTRAS  
 GAZETTER  
 GEOMETRY  
 INDEX  
 LABEL  
 SOFTWARE

### 10.2.2 Reserved File Names

The following file names are reserved. Not all of them are required in all cases. For a complete description of what files are required where and when, see Chapter 19, *Volume Organization and Naming*.

AAREADME.TXT	GAZINFO.TXT	PERSON.CAT
BROWINFO.TXT	GEOMINFO.TXT	REF.CAT
CALINFO.TXT	INDEX.TAB	SGIINFO.TXT
CATALOG.CAT	INDXINFO.TXT	SOFTINFO.TXT
CATINFO.TXT	INST.CAT	SUNINFO.TXT
CUMINDEX.TAB	INSTHOST.CAT	VOLDESC.CAT
DATASET.CAT	LABINFO.TXT	VOLDESC.SFD
DOCINFO.TXT	MACINFO.TXT	VOLINFO.TXT
ERRATA.TXT	MISSION.CAT	ZIPINFO.TXT
EXTRINFO.TXT	PCINFO.TXT	

### 10.2.3 Reserved Extensions

The following file extensions are reserved. A brief description is provided in the table below. Additional detail is contained in Chapter 19, *Volume Organization and Naming*, and Chapter 9, *Documentation Standard*.

Extension	Description (use with files of this type)
ASC	Plain ASCII documentation files
BC	SPICE Binary format CK (pointing) files
BSP	SPICE Binary format SPK (ephemeris) files
CAT	Catalog object(s)
CSV	SPREADSHEET object(s)
DAT	Binary files (other than images)
DLL	Dynamic Link Library
DOC	Microsoft Word document
EPS	Encapsulated Postscript
EXE	Application or Executable
FMT	Include file for describing data object (meta data)
GIF	GIF image
HTM <i>or</i> HTML	HTML document
IBG	Browse image data
IMG	Image data
IMQ	Image data that have been compressed
JPG	JPEG image
LBL	Detached label for describing data object
LIB	Library of object files
MAK	Makefile for compiling / linking application or executable
OBJ	Object file
PDF	Adobe PDF document
PNG	Portable Network Graphics
PS	Postscript
QUB	Spectral (or other) image QUBEs
RTF	Rich Text document
TAB	Tabular data, including ASCII TABLE objects with detached labels
TEX	TeX or LaTeX document
TI	SPICE Text IK (instrument parameters) files
TIF <i>or</i> TIFF	Tagged Image File Format documents
TLS	SPICE Leap seconds kernel files
TPC	SPICE Physical and cartographic constants kernel files
TSC	SPICE Spacecraft clock coefficients kernel files
TXT	Plain text documentation files
XC	SPICE Transfer format CK (pointing) files
XES	SPICE E-kernel files
XSP	SPICE Transfer format SPK (ephemeris) files
ZIP	Zip-compressed files within PDS

**Table 10.1 – Reserved File Extensions**

### 10.3 Guidelines for Naming Sequential Files

In cases where file names are constructed from a time tag or sequential data object identifier, the following forms are suggested (but not required):

Pnnnnnnn.EXT

where “.EXT” is the file extension (see above) and P is a character indicating:

- C     *nnnnnnnn* is a clock count value (e.g., “C3345678.IMG”)
- T     *nnnnnnnn* is a time value (e.g., “T870315.TAB”)
- F     *nnnnnnnn* is a frame ID or an image ID (e.g., “F242AO3.IMG”)
- N     *nnnnnnnn* is a numeric file identification number (e.g., “N003.TAB”)

**directories**

- reserved names, 10-3

**file extensions**

- reserved extensions, 10-3

**file names, 10-1**

- 27.3 convention, 10-2

- 8.3 convention, 10-2

- ISO 9660 Level 1, 10-2

- ISO 9660 Level 2, 10-2

- reserved extensions, 10-3

- reserved names, 10-3

- sequential file names, 10-5

- syntax, 10-2

**file specification**

- definition, 10-1

- example, 10-1

**ISO 9660**

- Level 1 file names, 10-2

- Level 2 file names, 10-2

# Chapter 11. Media Formats for Data Submission and Archive

This standard identifies the physical media formats to be used for data submission or delivery to the PDS or its science nodes. The PDS expects flight projects to deliver all archive products on magnetic or optical media. Electronic delivery of modest volumes of special science data products may be negotiated with the science nodes.

**Archive Planning** - During archive planning, the data producer and PDS will determine the medium (or media) to use for data submission and archiving. This standard lists the media that are most commonly used for submitting data to and subsequently archiving data with the PDS. Delivery of data on media other than those listed here may be negotiated with the PDS on a case-by-case basis.

**Physical Media for Archive** - For archival products only media that conform to the appropriate International Standards Organization (ISO) standard for physical and logical recording formats may be used.

1. The preferred data delivery medium is the Compact Disk (CD-ROM or CD-Recordable) produced in ISO 9660 format, using Interchange Level 1, subject to the restrictions listed in Section 10.1.1.
2. Compact Disks may be produced in ISO 9660 format using Interchange Level 2, subject to the restrictions listed in Section 10.1.2.
3. Digital Versatile Disk (DVD-ROM or DVD-R) should be produced in UDF-Bridge format (Universal Disc Format) with ISO 9660 Level 1 or Level 2 compatibility.

Because of hardware compatibility and long-term stability issues, the use of 12-inch Write Once Read Many (WORM) disk, 8-mm Exabyte tape, 4-mm DAT tape, Bernoulli Disks, Zip disks, Syquest disks and Jaz disks is not recommended for archival use. WORM disk formats are proprietary to the specific vendor hardware. Helical scan tape (8-mm or 4-mm) is prone to catastrophic read errors. Bernoulli, Zip, Jaz, Syquest and other vendor-specific storage media are prone to obsolescence.

## 11.1 CD-ROM Recommendations

### 11.1.1 Use of Variant Formats

The use of Extended Attribute Records (XARs), Rock Ridge Extensions or Macintosh Hybrid Disk Extensions on archival CD-ROMs is discouraged because these extensions can cause errors with CD-ROM drivers on some systems.

### **11.1.2 Premastering Recommendation**

PDS recommends that CD-ROMs be mastered using a single -session, single -track format. Other formats have been found to be incompatible with some readers.

## **11.2 DVD Recommendations**

### **11.2.1 Use of Variant Formats**

The official volume structure for DVD media is UDF. DVD volumes should not be produced using ISO 9660 only. While current operating systems support ISO 9660 on DVD volumes, there is no guarantee that future operating system upgrades, set-top boxes or other new devices will continue to support ISO 9660 formatted DVD volumes.

### **11.2.2 Premastering Recommendation**

PDS recommends that DVD-ROMs or DVD-Rs be mastered using a single -session, single -track format using the UDF-Bridge format.

### **11.2.3 Recommended DVD Formats**

There are currently three "variants" of DVD media :

- ?? DVD-5 - single sided, single layer (4.7 GB)
- ?? DVD-9 - single sided, double layer (8.5 GB)
- ?? DVD-10 - double sided, single layer (9.4 GB)

Currently, only the DVD-5 is approved by the PDS for archiving data. A waiver may be obtained for using the DVD-9 format if the archive consists of very large quantities of data (e.g., cost considerations may warrant using this format). The DVD-10 format is not recommended.

## **11.3 Packaging Software Files on a CD or DVD**

The ISO 9660 Level 1 standard requires all pathnames and directory names to be in uppercase, and to be limited to eight characters with a three -character file extension for file names. In some cases it may be desirable to include software packages on an ISO 9660 Level 1 archive product that do not conform to these naming standards. The recommended method for packaging software is to use a "Zip" utility in accordance with the PDS standards for archiving data using Zip compression. See the *Zip Compression* chapter for more information.

## **11.4 Software Packaging Under Previous Versions of the Standard**

Under previous versions of the Standards – prior to the adoption of the Zip standard (see the *Zip Compression* chapter ) – archive products that included software specifically intended for the



Mac and SUN operating systems used the following conventions:

## 1. Mac Software

In this case the Mac files must be prepared in a particular format, as other platforms do not recognize the resource and data fork files that come with Mac applications. (For an example of properly formatted Mac software, see the NIHIMAGE software on the Magellan GxDR and Clementine EDR CD-ROMs.) The Mac utility “STUFFIT” is used to prepare the files by compressing them and encoding them using the BINHEX utility . Users will also need this STUFFIT utility in order to unpack the software for use. The procedure and software requirements should be described in a text file included on the CD-ROM (in the appropriate SOFTWARE/DOCUMENT subdirectory – see the *Volume Organization and Naming* chapter in this document).

### ***Example – Text Documenting HQX Files***

#### Macintosh Software

This directory contains software that can be used to display the GXDR images on a Macintosh II computer with an 8-bit color display.

NOTE: Because of the way this CD-ROM was produced, it was not possible to record this display program as a Macintosh executable file. Anyone who is unfamiliar with the Macintosh STUFFIT utility should contact the PDS operator, 818-306-6026, SPAN address JPLPDS::PDS\_OPERATOR, INTERNET address PDS\_OPERATOR@JPLPDS.JPL.NASA.GOV

The file IMAGE.HQX contains the NIH Image program, along with several ancillary files and documentation in Microsoft WORD format. It was written by Wayne Rasband of the National Institutes of Health. The program can be used to display any of the image files on the GXDR CD-ROM disks.

The Image executable and manual are stored in BINHEX format, and the utility STUFFIT or UNSTUFFIT must be used to: 1) decode the BINHEX file IMAGE.HQX into IMAGE.SIT, using the 'DECODE BINHEX FILE...' option in the Other menu; and 2) use 'OPEN ARCHIVE' from the File menu to extract Image 1.40 from the STUFFIT archive file. There are also several other files in the archive file which should be unstuffed and kept together in the same folder as the Image executable is stored.

The STUFFIT software is distributed as shareware. STUFFIT, Version 1.5.1, is available by contacting:

Raymond Lau	MacNET:RayLau Usenet:raylau@dasys1.UUCP
100-04 70 Ave.	Genie:RayLau
Forest Hills, N.Y. 11375-5133	CIS:76174,2617
United States of America.	Delphi:RaymondLau

Alternatively, STUFFIT CLASSIC, Version 1.6, is available by contacting:

Aladdin Systems, Inc.  
Deer Park Center  
Suite 23A-171  
Aptos, CA 95003  
United States of America

## 2. SUN Software

The problem in this case is preserving the SUN file names, since case is significant in file names on that platform. Since the ISO standard requires all file and directory names to be uppercase, a disk premastered as an ISO CD may encounter problems in the case-sensitive SUN environment. Specifically, some CD readers mounted on SUN systems show file names as uppercase regardless of the format prior to mastering. If build routines ("make" files, for example) refer to lowercase file names, the corresponding files will not be found.

A method for dealing with this situation is to store the entire original directory structure and contents in a compressed, encoded archive (a compressed "tar" file, for example), and document the procedures and utilities needed to restore the files in the appropriate file. This is equivalent to the STUFFIT approach described above for Mac software.

**B**

Bernoulli Disks	
delivery medium .....	11-1
BINHEX utility .....	11-3

**C**

CD-Recordable	
delivery medium .....	11-1
CD-ROM	
delivery medium .....	11-1
formatting recommendations .....	11-2
premastering .....	11-2

**D**

DAT tape	
delivery medium .....	11-1
data delivery	
media .....	11-1
data submission .....	11-1
delivery media .....	11-1
DVD media	
archive format .....	11-2
DVD-R	
delivery medium .....	11-1
DVD-ROM	
delivery medium .....	11-1
formatting recommendations .....	11-2
premastering .....	11-2
UDF .....	11-2

**E**

Exabyte tape	
delivery medium .....	11-1
Extended Attribute Records (XARs)	
on delivery disks .....	11-2

**J**

Jaz disks	
delivery medium .....	11-1

<b>P</b>
----------

physical media formats ..... 11-1

<b>S</b>
----------

software

    packaging for delivery ..... 11-3

STUFFIT utility ..... 11-3

Syquest disks

    delivery medium ..... 11-1

<b>T</b>
----------

tar utility ..... 11-4

<b>W</b>
----------

WORM disk

    delivery medium ..... 11-1

<b>Z</b>
----------

Zip disks

    delivery medium ..... 11-1

# Chapter 12. Object Description Language Specification and Usage

The following provides a complete specification for Object Description Language (ODL), the language used to encode data labels for the Planetary Data System (PDS) and other NASA data systems. This standard contains a formal definition of the grammar semantics of the language. PDS specific implementation notes and standards are referenced in separate sections.

## 12.1 About the ODL Specification

This standard describes Version 2.1 of ODL. Version 2.1 of ODL supersedes Versions 0 and 1 of the language, which were used previously by the PDS and other groups. For the most part, ODL Version 2.1 is backwardly compatible with previous versions of ODL. There are, however, some features found in ODL Versions 0 and 1 that have been removed from or changed within Version 2. The differences between ODL versions are described in Section 12.7.

Following is a sample ODL data label describing a file and its contents:

```

/* File Format and Length */
    RECORD_TYPE           = FIXED_LENGTH
    RECORD_BYTES         = 800
    FILE_RECORDS         = 860
/* Pointer to First Record of Major Objects in File */
    ^IMAGE                = 40
    ^IMAGE_HISTOGRAM     = 840
    ^ANCILLARY_TABLE     = 842
/* Image Description */
    SPACECRAFT_NAME      = VOYAGER_2
    TARGET_NAME          = IO
    IMAGE_ID              = "0514J2-00"
    IMAGE_TIME            = 1979-07-08T05:19:11Z
    INSTRUMENT_NAME      = NARROW_ANGLE_CAMERA
    EXPOSURE_DURATION    = 1.9200 <SECONDS>
    NOTE                  = "Routine multispectral longitude
                           coverage, 1 of 7 frames"
/* Description of the Objects Contained in the File */
    OBJECT                = IMAGE
    LINES                 = 800
    LINE_SAMPLES         = 800
    SAMPLE_TYPE           = UNSIGNED_INTEGER
    SAMPLE_BITS           = 8
    END_OBJECT            = IMAGE

    OBJECT                = IMAGE_HISTOGRAM
    ITEMS                 = 25
    ITEM_TYPE             = INTEGER
    ITEM_BITS             = 32
    END_OBJECT            = IMAGE_HISTOGRAM

    OBJECT                = ANCILLARY_TABLE
    ^STRUCTURE            = "TABLE.FMT"
    END_OBJECT            = ANCILLARY_TABLE
END

```

### 12.1.1 Implementing ODL

Notes to implementers of software to read and write ODL-encoded data descriptions appear throughout the following sections. These notes deal with issues beyond language syntax and semantics, but are addressed to assure that software for reading and writing ODL will be uniform. The PDS, which is the major user of ODL-encoded data labels, has imposed additional implementation requirements for software used within the PDS. These PDS requirements are discussed below where appropriate.

#### 12.1.1.1 Language Subsets

Implementers are allowed to develop software to read or write subsets of the ODL. Specifically, software developers may opt to:

- Eliminate support for the GROUP statement (see Section 12.4.5.2 for additional information)
- Not support pointer statements
- Not support certain types of data values

For every syntactic element supported by an implementation, the corresponding semantics, as spelled out in this chapter, must be fully supported. Software developers should be careful to assure that language features will not be needed for their particular applications before eliminating them. Documentation on label reading/writing software should clearly indicate whether or not the software supports the entire ODL specification and, if not, should clearly indicate the features not supported.

#### 12.1.1.2 Language Supersets

Software for writing ODL must not provide or allow lexical or syntactic elements over and above those described below. With the exception of the PVL-specific extensions below, software for reading ODL must not provide or allow any extensions to the language.

#### 12.1.1.3 PDS Implementation of PVL-Specific Extensions

PDS implementation of software for reading ODL may, in some cases, provide handling of lexical elements that are included in the CCSDS specification of the Parameter Value Language (PVL), which is a superset of ODL. Extensions handled by such software include:

- BEGIN\_OBJECT as a synonym for the reserved word OBJECT
- BEGIN\_GROUP as a synonym for the reserved word GROUP
- Use of the semicolon (;) as a statement terminator

These lexical elements are not supported by software that writes the ODL subset. They must either be removed (in the case of semicolons) or replaced (in the case of the BEGIN\_OBJECT and BEGIN\_GROUP synonyms) upon output.

### 12.1.2 Notation

The formal description of the ODL grammar is given below in Backus-Naur Form (BNF). Language elements are defined using rules of the following form:

$$\text{defined\_element} ::= \text{definition}$$

where the definition is composed from the following components:

1. Lower case words, some containing underscores, are used to denote syntactic categories. For example:

`units_expression`

Whenever the name of a syntactic category is used outside of the formal BNF specification, spaces take the place of underscores (for example, units expression).

2. Boldface type is used to denote reserved identifiers. For example:

**object**

Special characters used as syntactic elements also appear in boldface type.

3. Square brackets enclose optional elements. Elements within brackets occur zero or one times.
4. Square brackets followed immediately by an asterisk or plus sign specify repeated elements. In the case of an asterisk, the elements in brackets may appear zero, one, or more times. In the case of a plus sign, the elements in brackets must appear at least once. The repetitions occur from left to right.
5. A vertical bar separates alternative elements.
6. If the name of any syntactic category starts with an italicized part, it is equivalent to the category name without the italicized part. The italicized part is intended to convey some semantic information. For example, both *object\_identifier* and *units\_identifier* are equivalent to `identifier`; *object\_identifier* is used in places where the name of an object is required and *units\_identifier* is used where the name of some unit of measurement is expected.

## 12.2 Character Set

The character set of ODL is the International Standards Organization's ISO 646 character set. The U.S. version of the ISO 646 character set is ASCII; the ASCII graphical symbols are used throughout this document. In other countries certain symbols have a different graphical representation.

The ODL character set is partitioned into letters, digits, special characters, spacing characters, format effectors and other characters:

```
character ::= letter | digit | special_character |
           spacing_character | format_effector |
           other_character
```

### 12.2.1 ODL Character Set - Letters

The letters are the uppercase letters A - Z and the lowercase letters a - z. ODL language elements are not case sensitive. Thus the following identifiers are equivalent:

- IMAGE\_NUMBER
- Image\_Number
- image\_number

Case is significant inside of literal text strings, i.e., string “abc” is not the same as the string “ABC”.

### 12.2.2 ODL Character Set - Digits

The digits are 0, 1, 2, 3, 4, 5, 6, 7, 8, 9.

### 12.2.3 ODL Character Set – Special Characters

The special characters used in ODL are:

Symbol	Name	Usage
=	Equals	The equals sign equates an attribute or pointer to a value.
{ }	Braces	Braces enclose an unordered set of values.
( )	Parentheses	Parentheses enclose an ordered sequence of values.
+	Plus	The plus sign indicates a positive numeric value.
-	Minus	The minus sign indicates a negative numeric value.
< >	Angle brackets	Angle brackets enclose a units expression associated with a numeric value.
.	Period	The period is the decimal place in real numbers.
"	Quotation Marks	Quotation marks denote the beginning and end of a text string value. Case is significant within the quotes of a text string.
'	Apostrophe	Apostrophes mark the beginning and end of a symbol value. Case is not significant within delimiting apostrophes (a.k.a. “single quotes”).



_	Underscore	The underscore separates words within an identifier.
,	Comma	The comma separates individual values in a set or sequence.
/	Slant	The slant character indicates division in units expressions. The slant is also part of the comment delimiter.
*	Asterisk	The asterisk indicates multiplication in units expressions. Two asterisks in a row indicate exponentiation in units expressions. The asterisk is also part of the comment delimiter.
:	Colon	The colon is used in attribute assignment statements to separate a namespace_identifier from an attribute_identifier (see Section 12.4.2).  The colon separates hours, minutes and seconds within a time value.
#	Crosshatch	Also known as “the pound sign”, this symbol delimits the digits in an integer number value expressed in notation other than base-10.
&	Ampersand	The ampersand denotes continuation of a statement onto another line.
^	Circumflex	The circumflex (or caret) indicates that a value is to be interpreted as a pointer.

#### 12.2.4 ODL Character Set – Spacing Characters

Two characters, called the spacing characters, separate lexical elements of the language and can be used to format characters on a line:

Space  
Horizontal Tabulation

#### 12.2.5 ODL Character Set – Format Effectors

The following ISO characters are format effectors, used to separate ODL encoded statements into lines:

Carriage Return  
Line Feed  
Form Feed  
Vertical Tabulation

The spacing characters and format effectors are discussed further in section 12.4.1 below. There are other characters in the ISO 646 character set that are not required to write ODL statements and labels. These characters may, however, appear within text strings and quoted symbolic literals:

! \$ % ; ? @ [ ] ` ~

### 12.2.6 ODL Character Set – Control Characters

The category of other characters also includes the ASCII control characters except for horizontal tabulation, carriage return, line feed, form feed and vertical tabulation (e.g., the control characters that serve as spacing characters or format effectors). As with the printing characters in this category, the control characters in this category can appear within a text string. The handling of control characters within text strings and symbolic literals is discussed in Section 12.3.3 below.

## 12.3 Lexical Elements

This section describes the lexical elements of ODL. Lexical elements are the basic building blocks of the ODL. Statements in the language are composed by stringing lexical elements together according to the grammatical rules presented in Section 12.4. The lexical elements of ODL are:

- Numbers
- Dates and Times
- Strings
- Identifiers
- Special symbols used for operators, etc.

There is no inherent limit on the length of any lexical element. However, software for reading and writing ODL may impose limitations on the length of text strings, symbol strings and identifiers. It is recommended that at least 32 characters be allowed for symbol strings and identifiers and at least 400 characters for text strings.

### 12.3.1 Numbers

ODL can represent both integer numbers and real numbers. Integer numbers are usually represented in decimal notation (“123”), but ODL also provides for integer values in other number bases (for example, “2#1111011#” is the binary representation of the decimal integer “123”). Real numbers can be represented in simple decimal notation (“123.4”) or in scientific notation (i.e., with a base 10 exponent: “1.234E2”).

#### 12.3.1.1 Integer Numbers In Decimal Notation

An integer number in decimal notation consists of a string of digits optionally preceded by a number sign. A number without an explicit sign is always taken as positive.

```
integer ::= [sign] unsigned_integer
unsigned_integer ::= [digit] +
```

sign ::= + | -

### *Examples – Decimal Integers*

0  
123  
+440  
-150000

#### **12.3.1.2 Integer Numbers In Based Notation**

An integer number in based notation specifies the number base explicitly. The number base must be in the range 2 to 16, which allows for representations in the most popular number bases, including binary (base 2), octal (base 8) and hexadecimal (base 16). In general, for a number base X the digits 0 to X-1 are used. For example, in octal (base 8) the digits 0 to 7 are allowed. If X is greater than 10, then the letters A, B, C, D, E, F (or their lower case counterparts) are used as needed for the additional digits.

A based integer may optionally include a number sign. A number without an explicit sign is always taken as positive.

based\_integer ::= radix # [sign] [extended\_digit] + #  
extended\_digit ::= digit | letter  
radix ::= unsigned\_integer

### *Examples – Based Integers*

2#1001011#  
8#113#  
10#75#  
16#4B#  
16#+4B#  
16#-4B#

All but the last example above are equivalent to the decimal integer number 75. The final example is the hexadecimal representation of -75 decimal.

#### **12.3.1.3 Real Numbers**

Real numbers may be represented in floating-point notation (“123.4”) or in scientific notation with a base 10 exponent (“1.234E2”). A real number may optionally include a sign. Unsigned numbers are always taken as positive.

real ::= [sign] unscaled\_real | [sign] scaled\_real  
unscaled\_real ::= unsigned\_integer. [unsigned\_integer] | .unsigned\_integer

```
scaled_real ::= unscaled_real exponent
exponent ::= E integer | e integer
```

Note that the letter ‘E’ in the exponent of a real number may appear in either upper or lower case.

### ***Examples – Real Numbers***

```
0.0
123.
+1234.56
-.9981
-1.E-3
31459e1
```

## **12.3.2 Dates and Times**

ODL includes lexical elements for representing dates and times. The formats for dates and times are a subset of the formats defined by the International Standards Organization draft standard ISO/DIS 8601. (For information regarding PDS specific use of dates and times, see the *Date/Time* chapter in this document.)

### **12.3.2.1 Date and Time Values**

Date and time scalar values represent a date, a time, or a combination of date and time:

```
date_time_value ::= date | time | date_time
```

The following rules apply to date values:

- The year must be Anno Domini. PDS requires a 4-digit year format be used (i.e., “2000”, not “00”).
- Month must be a number between 1 and 12.
- Day of month must be a number in the range 1 to 31, as appropriate for the particular month and year.
- Day of year must be in the range 1 to 365, or 366 in a leap year.

The following rules apply to time values:

- Hours must be in the range 0 to 23.
- Minutes must be in the range 0 to 59.
- Seconds, if specified, must be greater than or equal to 0 and less than 60.

The following rules apply to zone offsets within zoned time values:

- Hours must be in the range -12 to + 12 (the sign is mandatory).
- Minutes, if specified, must be in the range 0 to 59.

### 12.3.2.2 Implementation of Dates and Times

All ODL reading/writing software shall be able to handle any date within the 20th and 21st centuries. Software for writing ODL must always output full four-digit year numbers so that labels will be valid across century boundaries.

Times in ODL may be specified with unlimited precision, but the actual precision with which times will be handled by label reading/writing software is determined by the software implementers, based upon limitations of the hardware on which the software is implemented. Developers of label reading/writing software should document the precision to which times can be represented.

Software for writing ODL must not output local time values, since a label may be read in a time zone other than where it was written. Use either the UTC or zoned time format instead.

### 12.3.2.3 PDS Implementation of Dates and Times

PDS software for reading ODL labels interprets label times as UTC times. On output, a “Z” will be appended to label times.

### 12.3.2.4 Dates

Dates can be represented in two formats: as year and day of year; or as year, month and day of month.

date	:: = year_doy   year_month_day
year_doy	:: = year-doy
year_month_day	:: = year-month-day
year	:: = unsigned_integer
month	:: = unsigned_integer
day	:: = unsigned_integer
doy	:: = unsigned_integer

#### *Examples – Dates*

```
1990-07-04
1990-158
2001-001
```

### 12.3.2.5 Times

Times are represented as hours, minutes and (optionally) seconds using a 24-hour clock. Times may be specified in Universal Time Coordinated (UTC) by following the time with the letter Z

(for Zulu, a common designator for Greenwich Mean Time). Alternately, the time may be referenced to any time zone by following the time with a number that specifies the offset from UTC. Most time zones are an integral number of hours from Greenwich, but some are different by some non-integral time; both can be represented in the ODL. A time that is not followed by either the Zulu indicator or a time zone offset is assumed to be a local time.

```

time           ::= local_time | utc_time | zoned_time
local_time     ::= hour_min_sec
utc_time       ::= hour_min_sec Z
zoned_time     ::= hour_min_sec zone_offset
hour_min_sec   ::= hour: minute [:second]
zone_offset    ::= sign hour [: minute]
hour           ::= unsigned_integer
minute        ::= unsigned_integer
second        ::= unsigned_integer | unscaled_real

```

Note that either an integral or a fractional number of seconds can be specified in a time value.

### *Examples – Times*

```

12:00
15:24:12Z
01:10:39.4575+07 (time offset of 7 hours from UTC)

```

#### **12.3.2.5.1 Combining Date and Time**

A date and time can be specified together using the format below. Either of the two date formats can be combined with any time format - UTC, zoned or local.

```

date_time ::= date T time

```

The letter T separating the date from the time may be specified in either upper or lower case. Note that, because this is a lexical element, spaces may not appear within a date, within a time or before or after the letter T.

### *Examples – Date/Times*

```

1990-07-04T12:00
1990-158T15:24:12Z
2001-001T01:10:39.457591+7

```

### **12.3.3 Strings**

There are two kinds of string elements in ODL: text strings and symbol strings.

### 12.3.3.1 Text Strings

Text strings are used to hold arbitrary strings of characters.

$$\text{quoted\_text} ::= "[\text{character}]^*"$$

The empty string — a quoted text string with no characters within the delimiters — is allowed.

A quoted text string may not contain the quotation mark, which is reserved to be the text string delimiter. A quoted text string may contain format effectors, hence it may span multiple lines in a label: the lexical element begins with the opening quotation mark and extends to the closing quotation mark, even if the closing mark is on a following line. The rules for interpreting the characters within a text string, including format effectors, are given in the subsection on string values in Section 12.5.3.

### 12.3.3.2 Symbol Strings

Symbol strings are sequences of characters used to represent symbolic values. For example, an image ID may be a symbol string like 'J123-U2A', or a camera filter might be a symbol string like 'UV1'.

$$\text{quoted\_symbol} ::= '[\text{character}]^+'$$

A symbol string may not contain any of the following characters:

- The apostrophe, which is reserved to be the symbol string delimiter
- Format effectors, which means that a symbol string must fit on a single line
- Control characters

### 12.3.4 Identifiers

Identifiers are used as the names of objects, attributes and units of measurement. They can also appear as the value of a symbolic literal.

Identifiers are composed of letters, digits, and underscores. Underscores are used to separate words in an identifier. The first character of an identifier must be a letter. The last character may not be an underscore.

$$\text{identifier} ::= \text{letter} [\text{letter} \mid \text{digit} \mid \_ \text{letter} \mid \_ \text{digit}]^*$$

Because ODL is not case sensitive, lower case characters in an identifier can be converted to their upper case equivalent upon input to simplify comparisons and parsing.

#### *Examples – Identifiers*

```
VOYAGER
VOYAGER_2
```

```

BLUE_FILTER
USA_NASA_PDS_1_0007
SHOT_1_RANGE_TO_SURFACE

```

### 12.3.4.1 Reserved Identifiers

A few identifiers have special significance in ODL statements and are therefore reserved. They cannot be used for any other purpose (specifically, they may not be used to name objects or attributes):

end	end_group	end_object
group	object	begin_object

### 12.3.5 Special Characters

ODL is a simple language and it is usually clear where one lexical element ends and another begins. Spacing characters or format effectors may appear before a lexical element, between any pair of lexical elements, or after a lexical element without changing the meaning of a statement.

Some lexical elements incorporate special characters (e.g., the decimal point in real numbers or the quotation marks that delimit a text string). Some special characters are also lexical elements in their own right. These are:

- = The equals sign is the assignment operator.
- ,
- \* The asterisk serves as the multiplication operator in units expressions.
- / The slant serves as the division operator within units expressions.
- ^ The circumflex denotes a pointer to an object.
- ◊ The angle brackets enclose units expressions.
- () The parentheses enclose the elements of a sequence.
- { } The braces enclose the elements of a set.

The following two-character sequence is also a lexical element.

- \*\* Two adjacent asterisks are the exponentiation sign within units expressions.

## 12.4 Statements

An ODL-encoded label is made up of a sequence of zero, one, or more statements followed by the reserve identifier **end**.



```
label ::= [statement]*
      end
```

The body of a label is built from four types of statements:

```
statement ::= attribute_assignment_statement |
             pointer_statement |
             object_statement |
             group_statement
```

Each of the four types of statements is discussed below.

### 12.4.1 Lines and Records

Labels are also typically composed of lines, where each line is a string of characters terminated by a format effector or a string of adjacent format effectors. The following recommendations are given for how software that writes ODL should format a label into lines:

- There should be at most one statement on a line, although a statement may be more than a single line in length. As noted in Section 12.3.5 above, format effectors may appear before, after or between the lexical elements of a statement without changing the meaning of the statement. For example, the following statements are identical in meaning:

```
FILTER_NAME      = {RED, GREEN, BLUE}
FILTER_NAME      = {RED,
                   GREEN,
                   BLUE}
```

- Each line should end with a carriage return character followed immediately by a line feed character. This sequence is an end-of-line signal for most computer operating systems and text editors.
- The character immediately following the **END** statement must be either an optional spacing character or format effector, such as a space, line feed, carriage return, etc.

A line may include a comment. A comment begins with the two characters “/\*” and ends with the two characters “\*/”. A comment may contain any character in the ODL character set except format effectors, which are reserved to mark the end of line (i.e., comments may not be more than one line long). Comments are ignored when parsing an ODL label. When the comment delimiters (“/\*” and “\*/”) appear within a text string, they are not interpreted as a comment - they are simply part of the text string. For example, in the following example the comment will be included as part of the text string:

```
NOTE = "All good men come to the      /* Example of incorrect comment*/
      aid of their party"
```

Any characters on a line following a comment are ignored.

In some computer systems files are divided into records. Software for writing and reading ODL-encoded labels in record-oriented files should adhere to the following rules:

- A line of an ODL-encoded label may not cross a record boundary, i.e., each line should be contained within a single record. Any space left over at the end of a record after the last line in that record should be set to all space characters.
- The remainder of the record that contains the END statement is ignored. The data portion of the file begins with the next record in sequence.

## 12.4.2 Attribute Assignment Statement

The attribute assignment statement is the most common type of statement in ODL and is used to specify the value for an attribute of an object. The value may be a singular scalar value, an ordered sequence of values, or an unordered set of values.

The attribute assignment statement may optionally contain a `namespace_identifier`. When a `namespace_identifier` is prepended to the `element_identifier` statement, it indicates that the `element_identifier` has a local definition within the context indicated by the `namespace_identifier`.

`assignment_statement ::= attribute_identifier = value`

where `attribute_identifier ::= element_identifier |  
namespace_identifier:element_identifier`

The syntax and semantics of values are given in Section 12.5.

### *Examples – Assignment Statements*

```
RECORD_BYTES           = 800
TARGET_NAME            = JUPITER
SOLAR_LATITUDE         = (0.25 <DEG>, 3.00 <DEG>)
FILTER_NAME            = {RED,
                          GREEN,
                          BLUE }
```

### *Examples – Assignment Statements that use namespace\_identifier*

```
CASSINI:TARGET_NAME    = JUPITER
MRO:SOLAR_LATITUDE     = (0.25 <DEG>, 3.00 <DEG>)
VOYAGER:FILTER_NAME    = { RED, GREEN, BLUE }
```

## 12.4.3 Pointer Statement

The pointer statement indicates the location of an object.

```
pointer_statement ::= ^object_identifier = value
```

As with the attribute assignment statement, the value may be a scalar value, an ordered sequence of values, or an unordered set of values.

A common use of pointer statements is to reference a file containing an auxiliary label. For example:

```
^STRUCTURE = "TABLE.FMT"
```

This is a pointer statement pointing to a file named “TABLE.FMT” that contains a description of the structure of the ancillary table from our sample label. Another use of the pointer statement is to indicate the position of an object within another object. This is often used to indicate the position of major objects within a file. The following examples are from the sample label in Section 12.1:

```
^IMAGE           = 40
^IMAGE_HISTOGRAM = 840
^ANCILLARY_TABLE = 842
```

The first pointer statement above indicates that the image is located starting at the 40th record from the beginning of the present file. If an integer value is used to indicate the relative position of an object, the units of measurement of position are determined by the nature of the object. For files, the default unit of measurement is records. Alternatively, a units expression can be specified for the integer value to indicate explicitly the units of measurement for the position. For example, this pointer:

```
^IMAGE           = 10200 <BYTES>
```

indicates that the image starts 10,200 bytes from the beginning of the file.

The object pointers above reference locations in the same files as the label containing the pointer. Pointers may also reference either byte or record locations in data files that are detached, or separate, from the label file:

```
^IMAGE           = ("IMAGE.DAT", 10)
^HEADER          = ("IMAGE.DAT", 512 <BYTES>)
```

#### 12.4.4 OBJECT Statement

The OBJECT statement begins the description of an object. The description typically consists of a set of attribute assignment statements defining the values of the object’s attributes. If an object is itself composed of other objects, then OBJECT statements for the component objects are nested within the object’s description. There is no limit to the depth to which OBJECT statements may be nested.

The format of the OBJECT statement is:

```

object_statement ::= object = object_identifier
                  [statement ]*
                  end_object [= object_identifier]

```

The object identifier gives a name to the particular object being described. For example, in a file containing images of several planets, the image object descriptions might be named VENUS\_IMAGE, JUPITER\_IMAGE, etc. The object identifier at the end of the OBJECT statement is optional, but if it appears it must match the name given at the beginning of the OBJECT statement.

#### 12.4.4.1 Implementation of OBJECT Statements

It is recommended that all software for writing ODL include the object identifier at the end as well as the beginning of every OBJECT statement.

#### 12.4.5 GROUP Statement

The GROUP statement is used to group together statements that are not components of a larger object. For example, in a file containing many images, the group BEST\_IMAGES might contain the object descriptions of the three highest quality images. The three image objects in the BEST\_IMAGES group don't form a larger object: all they have in common is their superior quality.

The GROUP statement is also used to group related attributes of an object. For example, if two attributes of an image object are the time at which the camera shutter opened and closed, then the two attributes might be grouped as follows:

```

GROUP           = SHUTTER_TIMES
  START         = 12:30:42.177
  STOP          = 14:01:29.265
END_GROUP      = SHUTTER_TIMES

```

The format of the group statement is as follows:

```

group_statement ::= group = group_identifier
                  [statement ]*
                  end_group [= group_identifier]

```

The group identifier gives a name to the particular group, as shown in the example for shutter times above. The object identifier at the end of the GROUP statement is optional, but if it appears it must match the name given at the beginning of the GROUP statement. Groups may be nested within other groups. There is no limit to the depth to which groups can be nested.

As opposed to the above ODL implementation, the PDS applies the following restrictions to the

use of GROUPS:

1. The GROUP structure may only be used in a data product label which also contains one or more data OBJECT definitions.
2. A GROUP may not appear within any OBJECT other than an implicit or explicit FILE OBJECT.
3. The GROUP statement must contain only attribute assignment statements, include pointers, or related information pointers (i.e., no data location pointers).
4. GROUP statements may not be nested.
5. GROUP statements may not contain OBJECT definitions.
6. Only PSDD elements may appear within a GROUP statement.
7. The keyword contents associated with a specific GROUP identifier must be identical across all labels of a single data set (with the exception of the "PARAMETERS" GROUP, as explained .

Use of the GROUP structure must be coordinated with the responsible PDS discipline Node.

#### **12.4.5.1 Implementation of GROUP Statements**

It is recommended that all software for writing ODL include the group identifier at the end as well as the beginning of every GROUP statement.

#### **12.4.5.2 PDS Usage of GROUP**

Although ODL includes the GROUP statement, the PDS does not recommend its use because of confusion concerning the difference between OBJECT and GROUP.

### **12.5 Values**

ODL provides scalar values, ordered sequences of values, and unordered sets of values.

```
value ::= scalar_value | sequence_value | set_value
```

A scalar value consists of a single lexical element:

```
scalar_value ::= numeric_value |
               date_time_value |
               text_string_value |
               symbol_value
```

The format and use of each of these scalar values are discussed in the sections below.

### 12.5.1 Numeric Values

A numeric scalar value is either a decimal or based integer number, or a real number. A numeric scalar value may optionally include a units expression.

```
numeric_value ::= integer [units_expression] |
               based_integer [units_expression] |
               real [units_expression]
```

### 12.5.2 Units Expressions

Many of the values encountered in scientific data are measurements of something. In most computer languages, only the magnitude of a measurement is represented, without the units of measurement. ODL, however, can represent both the magnitude and the units of a measurement. A units expression has the following format:

```
units_expression      ::= < units_factor [mult_op units_factor] * >
units_factor          ::= units_identifier [exp_op integer]
mult_op               ::= * | /
exp_op                ::= **
```

A units expression is always enclosed within angle brackets. The expression may consist of a single units identifier like “KM”, for kilometers, or “SEC”, for seconds (for example, “1.341E6 <KM>” or “1.024 <SEC>”). More complex units can also be represented; for example, the velocity “3.471 <KM/SEC>” or the acceleration “0.414 <KM/SEC/SEC>”. There is often more than one way to represent a unit of measure. For example:

```
0.414      <KM/SEC/SEC>
0.414      <KM/SEC**2>
0.414      <KM*SEC**-2>
```

are all valid representations of the same acceleration. The following rules apply to units expressions:

- The exponentiation operator can specify only a decimal integer exponent. The exponent value may be negative, which signifies the reciprocal of the units. For example, “60.15 <HZ>” and “60.15 <SEC\*\*-1>” are both ways to specify a frequency.
- Individual units may appear in any order. For example, a force might be specified as either “1.55 <GM\*CM/SEC\*\*2>” or “1.55 <CM\*GM/SEC\*\*2>”.

#### 12.5.2.1 Implementation of Numeric Values

There is no defined maximum or minimum magnitude or precision for numeric values. In general, the actual range and precision of numbers that can be represented will be different for each kind of computer used to read or write an ODL-encoded label. Developers of software for

reading/writing ODL should document the following:

- The largest magnitude positive and negative integers that can be represented
- The largest magnitude positive and negative real numbers that can be represented
- The minimum number of significant digits that a real number can be guaranteed to have without loss of precision. This is to account for the loss of precision that can occur when representing real numbers in floating point format within a computer. For example, a 32-bit floating-point number with 24 bits for the mantissa can guarantee at most 6 significant digits will be exact (the seventh and subsequent digits may not be exact because of truncation and round-off errors).

If software for reading ODL encounters a numeric value too large to be represented, the software must report an error to the user.

### 12.5.3 Text String Values

A text string value consists of a text string lexical element:

`text_string_value ::= quoted_text`

#### 12.5.3.1 Implementation of String Values

A text string read in from a label is reassembled into a string of characters. The way in which the string is broken into lines in a label does not affect the format of the string after it has been reassembled. The following rules are used when reading text strings:

- If a format effector or a sequence of format effectors is encountered within a text string, the effector (or sequence of effectors) is replaced by a single space character, unless the last character is a hyphen (dash) character. Any spacing characters at the end of the line are removed and any spacing characters at the beginning of the following line are removed. This allows a text string in a label to appear with the left and right margins set at arbitrary points without changing the string value. For example, the following two strings are the same:

“To be or not to be”

and

“To be or  
not to be”

- If the last character on a line prior to a format effector is a hyphen (dash) character, the hyphen is removed with any spacing characters at the beginning of the following line. This follows the standard convention in English of using a hyphen to break a word across lines. For example, the following two strings are the same:

“The planet Jupiter is very big”

and

“The planet Jupi-  
ter is very big”

- Control codes, other than the horizontal tabulation character and format effectors, appearing within a text string are removed.

### 12.5.3.1.1 PDS Text String Formatting Conventions

The PDS defines a set of format specifiers that can be used in text strings to indicate the formatting of the string on output. These specifiers can be used to indicate where explicit line breaks should be placed, and so on. The format specifiers are:

- `\n` Indicates that an end-of-line sequence should be inserted.
- `\t` Indicates that a horizontal tab character should be inserted.
- `\f` Indicates that a page break should be inserted.
- `\v` Must be used in pairs, begin and end. Interpreted as verbatim.
- `\\` Used to place a backslash in a text string.

For example, the string

“This is the first line `\n` and this is the second line.”

will print as:

This is the first line  
and this is the second line.

**Note:** These format specifiers have meaning only when a text string is printed - not when the string is read in or stored.

### 12.5.4 Symbolic Literal Values

A symbolic value may be specified as either an identifier or a symbol string:

symbolic-value ::= identifier | quoted\_symbol



The following statements assign attributes to symbolic values specified by identifiers:

```
TARGET_NAME           = IO
SPACECRAFT_NAME       = VOYAGER_2
SPACECRAFT_NAME       = 'VOYAGER-2'
SPACECRAFT_NAME       = 'VOYAGER 2'
REFERENCE_KEY_ID      = SMITH1997
REFERENCE_KEY_ID      = 'LAUREL&HARDY1997'
```

The quotes must be used if the symbolic value does not have the proper format for an identifier or if it contains characters not allowed in an identifier. For example, the value 'FILTER+\_7' must be enclosed within quotes, since this would not be a legal ODL identifier. Similarly, the symbolic value 'U13-A4B' must be in quotes because it contains a special character (the dash) not allowed in an identifier. There is no harm in putting a legal identifier within quotes. For example:

```
SPACECRAFT_NAME = 'VOYAGER_2'
```

is equivalent to the second example in the list above.

Symbolic values may not contain format effectors, i.e., they may not cross a line boundary.

#### 12.5.4.1 Implementation of Symbolic Literal Values

Symbolic values are converted to upper case on input. This means that a lowercase string is converted to the equivalent uppercase string; as in the following example:

```
Original string:  SPACECRAFT_NAME = 'Voyager_2'
Converted string: SPACECRAFT_NAME = 'VOYAGER_2'
```

#### 12.5.4.2 PDS Convention for Symbolic Literal Values

Since the current use of the ODL within the PDS does not require syntactic differentiation between symbols and text strings, PDS prefers that double quotation marks (") be used instead of apostrophes around symbol strings.

#### 12.5.5 Sequences

A sequence represents an ordered set of values. It can be used to represent arrays and other kinds of ordered data. Only one- and two-dimensional sequences are allowed.

```
sequence_value      ::= sequence_1D | sequence_2D
sequence_1D         ::= (scalar_value [, scalar_value]*)
sequence_2D         ::= ([sequence_1D] +)
```

A sequence may have any kind of scalar value for its members. It is not required that all the members of the sequence be of the same type. Thus a sequence may represent a heterogeneous record. Each member of a two-dimensional sequence is a one-dimensional sequence. This can be used, for example, to represent a table of values. The order in which members of a sequence appear must be preserved. There is no upper limit on the number of values in a sequence.

For example: `AVERAGE_ECCENTRICITY = (0, 1, 2, 3, 4, 5, 9)`

## 12.5.6 Sets

Sets are used to specify unordered values drawn from some finite set of values.

```
set_value ::= {scalar_value [, scalar_value]*} | {}
```

Note that the empty set is allowed: The empty set is denoted by opening and closing brackets with nothing except optional spacing characters or format effectors between them.

The order in which the members appear in the set is not significant and the order need not be preserved when a set is read and manipulated. There is no upper limit on the number of values in a set.

### *Example*

```
FILTER_NAME = { RED, BLUE, GREEN, HAZEL }
```

### 12.5.6.1 PDS Restrictions on Sets

The PDS allows only symbol values and integer values within sets.

## 12.6 ODL Summary

### *Character Set (Section 12.2)*

ODL uses the ISO 646 character set (the American version of the ISO 646 standard is ASCII). The ODL character set is partitioned as follows:

```
character      ::= letter | digit | special_character |
                spacing_character | format_effector |
                other_character
letter         ::= A-Z | a-z
digit         ::= 0 | 1 | 2 | 3 | 4 | 5 | 6 | 7 | 8 | 9
special_character ::= { | } | ( | ) | + | - | . | " | ' | = |
                    _ | , | / | * | : | # | & | ^ | < | >
spacing_character ::= space | horizontal tabulation
```

```

format_effector      ::= carriage return | line feed |
                        form feed | vertical tabulation
other_character      ::= ! | $ | % | ; | ? | @ | [ | ] | ` | ~ |
                        vertical bar | other control characters

```

### *Lexical Elements (Section 12.3)*

```

integer              ::= [sign] unsigned_integer
unsigned_integer     ::= [digit]+
sign                 ::= + | -
based_integer        ::= radix # [sign] [extended_digit]+ #
extended_digit       ::= digit | letter
radix                ::= unsigned_integer
real                 ::= [sign] unscaled_real | [sign] scaled_real
unscaled_real        ::= unsigned_integer . [unsigned_integer] |
                        . unsigned_integer
scaled_real          ::= unscaled_real exponent
exponent             ::= E integer | e integer
date                 ::= year_doy | year_month_day
year_doy             ::= year - doy
year_month_day       ::= year - month - day
year                 ::= unsigned_integer
month                ::= unsigned_integer
day                  ::= unsigned_integer
doy                  ::= unsigned_integer
time                 ::= local_time | utc_time | zoned_time
local_time           ::= hour_min_sec
utc_time             ::= hour_min_sec Z
zoned_time           ::= hour_min_sec zone_offset
hour_min_sec         ::= hour : minute [ : second]
zone_offset          ::= sign hour [ : minute]
hour                 ::= unsigned_integer
minute               ::= unsigned_integer
second               ::= unsigned_integer | unscaled_real
date_time            ::= date T time
quoted_text          ::= “[character]*”
quoted_symbol        ::= ‘[character]+’
identifier           ::= letter [letter | digit | _letter | _digit ]*

```

### *Statements (Section 12.4)*

```

label                ::= [statement]*
                        end
statement             ::= assignment_stmt | pointer_stmt |
                        object_stmt | group_stmt

```

```

assignment_stmt      ::= element_identifier = value |
                        namespace_identifier:element_identifier = value
pointer_stmt         ::= ^object_identifier = value
object_stmt          ::= object = object_identifier
                        [statement]*
                        end_object [= object_identifier]
group_stmt           ::= group = group_identifier
                        [statement]*
                        end_group [= group_identifier]

```

### Values (Section 12.5)

```

value                ::= scalar_value | sequence_value | set_value
scalar_value         ::= numeric_value | date_time_value |
                        text_string_value | symbolic_value
numeric_value        ::= integer [units_expression] |
                        based_integer [units_expression] |
                        real [units_expression]
units_expression     ::= <units_factor[mult_op units_factor]* >
units_factor         ::= units_identifier [exp_op integer]
mult_op              ::= * | /
exp_op               ::= **
date_time_value      ::= date | time | date_time
text_string_value    ::= quoted_text
symbolic_value       ::= identifier | quoted_symbol
sequence_value       ::= sequence_ID | sequence_2D
sequence_1D          ::= (scalar_value [, scalar_value]*)
sequence_2D          ::= ([sequence_ID]+)
set_value            ::= { scalar_value [,scalar_value]* } | { }

```

## 12.7 Differences Between ODL Versions

This section summarizes the differences between the current Version 2 of ODL and the previous Versions 0 and 1. Software can be constructed to read all three versions of ODL, however it is important that software for writing labels only write labels that conform to ODL Version 2.

### 12.7.1 Differences from ODL Version 1

Version 1 labels were used on the *Voyager to the Outer Planets* CD-ROM disks and many other data sets. Version 1 did not include the GROUP statement and had more restrictive definitions for sets, which were limited to integer or symbolic literal values, and sequences, which were limited to arrays of homogeneous values. The following sections detail non-compatible differences and how they can be handled by software writers.

### 12.7.1.1 Ranges

Version 1 of ODL had a specific notation for integer ranges:

```
range_value ::= integer..integer
```

This notation is not allowed in ODL Version 2, though parsers may still recognize the ‘double-dot’ range notation. On output, a range is now encoded as a two value sequence, with the low-value of the range being the first element of the sequence and the high-value being the second element of the sequence.

#### 12.7.1.1.1 Delimiters in Sequences and Sets

In Version 1 the individual values in sets and sequences could be separated by a comma or by a spacing character. As of Version 2, a comma is required. Parsers may allow spacing characters between values rather than commas. Software that writes ODL should place commas between all values in a sequence or set.

#### 12.7.1.1.2 Exponentiation Operator in Units Expressions

In Version 1 of ODL the circumflex character (^) was used as the exponentiation operator in units expressions rather than the two-asterisk sequence (\*\*). Parsers may still allow the circumflex to appear within units expressions as an exponentiation operator. Software for writing ODL should use only the \*\* notation.

## 12.7.2 Differences from ODL Version 0

Version 0 of ODL was developed for and used on the *PDS Space Science Sampler* CD-ROM disks. The major difference between this and subsequent versions is that Version 0 did not include the OBJECT statement. All of the attributes specified in a label described a single object: the file that contained the label (or that was referenced by a pointer).

### 12.7.2.1 Date–Time Format

ODL Version 0 was produced prior to the space community's acceptance of the ISO/DIS 8601 standard for dates and time and it uses a different date and date-time format. The format for Version 0 dates and date-times is as follows:

```
date           ::= year / month / day_of_month | year / day_of_year
date_time     ::= date - time zone
zone          ::= < identifier >
```

The options for time specification in ODL Version 0 are a subset of those in Version 2. Consequently, parsers that handle Version 2 time formats will also handle Version 0 times.

### 12.7.3 ODL/PVL Usage

The concept for a Parameter Value Language/Format (PVL) is being formalized by the Consultative Committee for Space Data Systems (CCSDS). It is intended to provide a human readable data element/value structure to encode data for interchange. The CCSDS version of the PVL specification is in preliminary form.

Some organizations that deal with the PDS have accepted PVL as their standard language for product labels. PVL is a superset of ODL, so some PVL constructs are not supported by the PDS. In addition, some ODL constructs may be interpreted differently by PVL software.

The ODL/PVL usage standard defines restrictions on the use of ODL/PVL in archive quality data sets. These restrictions are intended to ensure the compatibility of PVL with ODL and existing software.

1. A label constructed using PVL may be attached - embedded in the same file as the data object it describes, or detached - residing in a separate file and pointing to the data file the label describes.
2. All statements must be terminated by a <CR> <LF> pair. Semicolons may not be used to terminate statements.
3. Only alphanumeric characters and the underscore character may be used in data elements and undelimited text values (literals). In addition, data elements and undelimited text values must begin with a letter.
4. Keywords must be 30 characters or less in length.
5. Keywords and standard values must be in upper case. Literals and strings may be in upper case, lower case, or mixed case.
6. Comments must be contained on a single line, and a comment terminator (\*/) must be used. Comments may not be embedded within statements. Comments may not be used on the same line as any statement if the comment precedes the statement. Comments may be on the same line as a statement if the comment follows the statement and is separated from the statement by at least one white space, but this is not recommended.
7. Text values that cross line boundaries must be enclosed in double quotation marks (“ ”).
8. Values that consist only of letters, numbers, and underscores and that begin with a letter may be used without quotation marks. All other text values must be enclosed in either single ( ‘ ’ ) or double ( “ ” ) quotation marks.

9. Sequences are limited to two dimensions. Null (empty) sequences are not allowed. Sets are limited to one dimension. In other words, sets and sequences may not be used inside a set.
10. Only the OBJECT, END\_OBJECT, GROUP and END\_GROUP aggregation markers may be used.
11. Unit expressions are only allowed following numeric values (i.e., “DATA\_ELEMENT = 7 <BYTES>” is valid. but “DATA\_ELEMENT = MANY <METERS>” is not).
12. Unit expressions may include only alphanumeric characters, the underscore, and the symbols “\*”, “/”, “(”, “)”, and “\*\*” (the last representing exponentiation).
13. Signs may not be used in non-decimal numbers (i.e., “2#10001#” is valid, but “-2#10001#” and “2#-10001#” are not). Only the bases 2, 8, and 16 may be used for non-decimal numbers.
14. Alternate time zones (e.g., YYYY-MM-DDTHH:MM:SS.SSS + HH:MM) may not be used. The only allowed time format is YYYY-MM-DDTHH:MM:SS.SSS.
15. Values in integral parts of dates and times must be padded on the left with zeroes as necessary to fill the field. In other words, the first of April in the year 2001 must be written as “2001-04-01”, *not* “2001-4-1”
16. AnEND statement must conclude each ODL/PVL statement list.

The following are guidelines for formatting ODL/PVL expressions.

1. The assignment symbol (=) must be surrounded by blanks.
2. Assignment symbols (=) should be aligned if possible.
3. Keywords placed inside an aggregator (OBJECT or GROUP) must be indented with respect to the OBJECT and END\_OBJECT or GROUP and END\_GROUP statements which enclose them.
4. PDS label lines must be 80 characters or less in length, including the end-of-statement (i.e., <CR> <LF>) delimiter. (Note that while 80 characters can be displayed on most screens, some editors and databases will wrap or truncate lines that exceed 72 characters.)
5. Horizontal tab characters may not be used in PDS labels. Although both ODL and PVL allow the use of these characters some simple parsers cannot handle them. The equivalent number of space characters should be used instead.





- GROUP, 12-15
  - PDS use, 12-16
- OBJECT, 12-15
- Object Description Language (ODL)
  - character set, 12-3
  - comments, 12-13
  - date and time formats, 12-8
  - date formats, 12-9
  - END statement, 12-13
  - file format, 12-13
  - identifiers
    - reserved, 12-12
    - syntax, 12-11
  - implementation
    - date and time, 12-9
  - implementation notes, 12-2
  - integer formats, 12-6, 12-7
  - language summary, 12-21**
  - lexical elements, 12-6
  - numeric values, 12-17
  - Parameter Value Language (PVL), 12-25
  - PDS implementation, 12-2
    - date and time, 12-9
    - sets, 12-21
    - symbolic literals, 12-20
  - PVL guidelines, 12-26
  - PVL restrictions on archive files, 12-25
  - real number formats, 12-7
  - revision notes, 12-23
    - version 0, 12-24
    - version 1, 12-23
  - sample data label, 12-1
  - sequences, 12-20
  - sets, 12-21
  - special characters, 12-12
  - specification, 12-1
  - statements, 12-12
    - assignment, 12-14
    - GROUP, 12-15
    - OBJECT, 12-15
    - pointer, 12-14
  - symbol strings, 12-11
  - symbolic literals, 12-20
  - text string values, 12-18
  - text strings, 12-10

time formats, 12-9

units of measure, 12-17

Parameter Value Language (PVL), 12-2, 12-25

# Chapter 13. PDS Objects / Groups

The Planetary Data System has designed a set of standard Objects and Groups to be used for submitting catalog object information as well as for labeling data products. These standard Objects and Groups, along with definitions of individual keywords comprising those Objects and Groups, are defined in the *Planetary Science Data Dictionary*. In addition, Object and Group definitions and examples are also included in Appendix A and Appendix B of this document.

## 13.1 Generic and Specific Data Object Definitions

For each type of data object that PDS has defined (i.e., IMAGE, TABLE, etc.), there are two categories of definitions: generic and specific. A *generic object definition* is the universal definition of an object, or superset of keywords that can be used. A *specific object definition* is a subset of keywords used for a particular data product to allow effective use of validation tools.

Generic object definitions are designed and approved by the Planetary Data System, and defined in the *Planetary Science Data Dictionary*. Each object definition lists the elements and sub-objects required to be present each time the object is used in a product label. The dictionary definition also provides a list of additional, optional keywords that are frequently used by data preparers. Finally, note that any element defined in the PSDD may be included as an optional element in any object definition, at the discretion of the data preparer.

A specific object definition is defined for a particular data product and is based on a single generic object. The data preparer, in consultation with a data engineer, combines all the required elements of that object with a set of optional elements selected for their relevance to the data at hand. The result is a specific object definition. This definition is subject to approval during a design review.

The following examples illustrate the evolution from the generic IMAGE object to a specific IMAGE object, followed by an instance of that specific IMAGE. Note that when a specific object definition is created and used, the usage must be consistent for all labels using that object.

```
OBJECT          = GENERIC_OBJECT_DEFINITION
NAME           = IMAGE
STATUS_TYPE    = APPROVED
STATUS_NOTE    = "V2.1 1991-01-20 MDM New Data Object Definition"
DESCRIPTION    = "An image object is a regular array of sample
values. Image objects are normally processed with special display tools to
produce a visual representation of the sample values. This is done by assigning
brightness levels or display colors to the various sample values. Images are
composed of LINES and SAMPLES. They may contain multiple bands, in one of
several storage orders."
```

Note: Additional engineering values may be prepended or appended to each LINE of an image, and are stored as concatenated TABLE objects, which must be named LINE\_PREFIX and LINE\_SUFFIX. IMAGE objects may be associated with other objects, including HISTOGRAMS, PALETTES, HISTORYs and TABLEs which contain statistics, display parameters, engineering values or other ancillary data."

```
SOURCE_NAME    = "PDS CN/M.MARTIN"
REQUIRED_ELEMENT_SET = {LINE_SAMPLES, LINES, SAMPLE_BITS,
SAMPLE_TYPE}
OPTIONAL_ELEMENT_SET = {BAND_SEQUENCE, BAND_STORAGE_TYPE,
```

```

BANDS, CHECKSUM, DERIVED MAXIMUM,
DERIVED MINIMUM, DESCRIPTION,
ENCODING TYPE, FIRST LINE,
FIRST LINE SAMPLE, INVALID,
LINE PREFIX BYTES, LINE SUFFIX BYTES, MISSING,
OFFSET, SAMPLE BIT MASK, SAMPLING FACTOR,
SCALING FACTOR, SOURCE FILE NAME,
SOURCE LINES, SOURCE LINE SAMPLES,
SOURCE SAMPLE BITS, STRETCHED FLAG,
STRETCH MAXIMUM, STRETCH MINIMUM, PSDD)
REQUIRED_OBJECT_SET      = "N/A"
OPTIONAL_OBJECT_SET      = "N/A"

OBJECT_CLASSIFICATION_TYPE = STRUCTURE

OBJECT                    = ALIAS
NAME                      = "N/A"
USAGE_NOTE                = "N/A"
END_OBJECT                = ALIAS

END_OBJECT                = GENERIC_OBJECT_DEFINITION

```

---

This next example illustrates an IMAGE object definition being used for a specific case.

---

```

OBJECT                    = SPECIFIC_OBJECT_DEFINITION
NAME                      = XYZ IMAGE
STATUS_TYPE               = APPROVED
STATUS_NOTE                = "V2.1 1991-02-10 TMA New specific data object
                             definition"
DESCRIPTION                = "The XYZ image is..."

SOURCE_NAME                = "PDS CN/M.MARTIN"
REQUIRED_ELEMENT_SET      = {LINE_SAMPLES, LINES, SAMPLE_BITS,
                             SAMPLE_TYPE, SAMPLING_FACTOR,
                             SOURCE_FILE_NAME,
                             SOURCE_LINES, SOURCE_LINE_SAMPLES,
                             SOURCE_SAMPLE_BITS, FIRST_LINE,
                             FIRST_LINE_SAMPLE}

OBJECT_CLASSIFICATION_TYPE = STRUCTURE

OBJECT                    = ALIAS
NAME                      = "N/A"
USAGE_NOTE                = "N/A"
END_OBJECT                = ALIAS

END_OBJECT                = SPECIFIC_OBJECT_DEFINITION

```

### 13.1.1 Primitive Objects

Generic objects have a subclass called primitive objects that includes the ARRAY, COLLECTION, ELEMENT, and BIT\_ELEMENT objects. The primitive objects are used as the building blocks for describing very irregular data that cannot be accommodated by any other generic object. If at all possible, standard, well-supported generic objects (such as TABLE and IMAGE) should be used to describe archival data.

## 13.2 Generic and Specific Data Group Definitions

For each type of data Group that PDS has defined (i.e., PARAMETERS, etc.), there are two categories of definitions: generic and specific. A *generic group definition* is the universal definition of a group, or superset of keywords that can be used. A *specific group definition* is a subset of keywords used for a particular data product to allow effective use of validation tools.

As with OBJECTs (see PDS Standards Reference, section 13.1), there are two categories of GROUPs, generic and specific. The generic GROUP is the universal definition of the GROUP, specified in an appendix of the Standards Reference. The specific GROUP is an implementation of the generic GROUP for a particular data set. Shown below is a generic GROUP definition, and then an example of an instance of that GROUP in a data product.

```

OBJECT          = GENERIC_GROUP_DEFINITION
NAME           = CAMERA_MODEL
STATUS_TYPE    = PENDING
STATUS_NOTE    = "V1.0 2001-07-09 EDR New Group Definition"
DESCRIPTION    = "A camera model group is a collection of parameters
necessary to fully describe the geometric characteristics of a camera system."

SOURCE_NAME    = "PDS IMG/E. RYE"
REQUIRED_ELEMENT_SET = {CAMERA_MODEL_NAME, CAMERA_MODEL_TYPE,
CAMERA_MODEL_DESC, CALIBRATION_SOURCE_ID,
GEOMETRY_SOURCE_ID, COORDINATE_SYSTEM_NAME,
MODEL_COMPONENT_ID, MODEL_COMPONENT_NAME,
MODEL_COMPONENT_UNIT_ID}
OPTIONAL_ELEMENT_SET = {MODEL_COMPONENT_1_VECTOR,
MODEL_COMPONENT_2_VECTOR,
MODEL_COMPONENT_3_VECTOR,
MODEL_COMPONENT_4_VECTOR,
MODEL_COMPONENT_5_VECTOR,
MODEL_COMPONENT_6_VECTOR,
MODEL_COMPONENT_7_VECTOR, PSDD}

OBJECT        = ALIAS
NAME          = "N/A"
USAGE_NOTE    = "N/A"
END_OBJECT    = ALIAS

END_OBJECT    = GENERIC_GROUP_DEFINITION

```

An example of using a GROUP follows:

```

GROUP          = CAMERA_MODEL
CAMERA_MODEL_NAME = "MIPS-0"
CAMERA_MODEL_TYPE = "CAHV"
^CAMERA_MODEL_DESC = "CAHV.ASC"
CALIBRATION_SOURCE_ID = "UOFA-BACKLASH"
GEOMETRY_SOURCE_ID = "TELEMETRY"
COORDINATE_SYSTEM_NAME = "IMP-CAMERA"
MODEL_COMPONENT_ID = (C, A, H, V)
MODEL_COMPONENT_NAME = ("CENTER", "AXIS",
"HORIZONTAL", "VERTICAL")
MODEL_COMPONENT_UNIT_ID = ("m", "none", "pixel", "pixel")
MODEL_COMPONENT_1_VECTOR = (3.469, 14.593, 8.937)
MODEL_COMPONENT_2_VECTOR = (0.351, 0.758, 17.932)
MODEL_COMPONENT_3_VECTOR = (14.020, 15.336, 23.714)
MODEL_COMPONENT_4_VECTOR = (27.423, 3.719, 16.426)
END_OBJECT    = CAMERA_MODEL

```

In order to facilitate the inclusion of multiple instances of keywords within data product labels without requiring a whole host of new GROUPs, there is a special GROUP called the PARAMETERS GROUP. It has no required elements, and the set of all elements in the PSDD as its optional element set.

```

OBJECT          = GENERIC_GROUP_DEFINITION
NAME           = PARAMETERS
STATUS_TYPE    = PENDING
STATUS_NOTE    = "V1.0 2001-07-09 EDR New Group Definition"
DESCRIPTION    = "The parameters group provides a mechanism for
                  Grouping multiple sets of related parameters
                  within a data product label."

SOURCE_NAME    = "PDS IMG/E. RYE"
REQUIRED_ELEMENT_SET = {}
OPTIONAL_ELEMENT_SET = {PSDD}

OBJECT          = ALIAS
NAME           = "N/A"
USAGE_NOTE    = "N/A"
END_OBJECT    = ALIAS

END_OBJECT    = GENERIC_GROUP_DEFINITION

```

For example:

```

GROUP          = COMMANDED_INST_PARAMETERS
SHUTTER_MODE   = "BOTSIM"
FILTER_NUMBER  = 5
FILTER_NAME    = "L570-R570"
EXPOSURE_DURATION = 1.05
END_OBJECT    = COMMANDED_INST_PARAMETERS

GROUP          = TELEMETRY_INST_PARAMETERS
SHUTTER_MODE   = "AUTO"
FILTER_NUMBER  = 0
FILTER_NAME    = "CLEAR"
EXPOSURE_DURATION = 0.773
END_OBJECT    = TELEMETRY_INST_PARAMETERS

```

### 13.2.1 Implementation of Group Statements

PDS applies the following restrictions to the use of GROUPs:

1. The GROUP structure may only be used in a data product label which also contains one or more data OBJECT definitions.
2. A GROUP may not appear within any OBJECT other than an implicit or explicit FILE OBJECT.
3. The GROUP statement must contain only attribute assignment statements, include pointers, or related information pointers (i.e., no data location pointers).
4. GROUP statements may not be nested.
5. GROUP statements may not contain OBJECT definitions.
6. Only PSDD elements may appear within a GROUP statement.

7. The keyword contents associated with a specific GROUP identifier (e.g., CAMERA\_MODEL) must be identical across all labels of a single data set.

Usage of a GROUP structure must be coordinated with and approved by the responsible PDS discipline Node.

Descriptors may be pre-pended to any generic Group name to produce, and distinguish between, specific instances of the generic group (i.e., any generic Group name may be preceded with a qualifier to uniquely identify the specific instance of the generic Group). For example, the generic PARAMETERS Group could have specific instances of "A\_PARAMETERS", "B\_PARAMETERS", etc. Pre-pending a descriptor to the generic instances allows multiple instances of the Group to be repeated within a single label.

The specific GROUP is an implementation of the generic GROUP for a particular data set and must be consistent in its structure (i.e., use the same set of keywords) across the data set. For example, the PARAMETERS Group may consist of any keywords defined within the PSDD.

In the following examples, the TELEMETRY\_GEOMETRY\_PARAMETERS Group consists of three keywords and the CORRECTED\_GEOMETRY\_PARAMETERS Group consists of three keywords. In this case, both specific instances use the same keywords but could consist of different sets of keywords. Both instances can be collocated within a single data product label. But, each instance across the dataset must contain the same set of keywords.

```

GROUP                                = TELEMETRY_GEOMETRY_PARAMETERS
  GEOMETRY_SOURCE_ID                 = "TELEMETRY"
  INSTRUMENT_AZIMUTH                 = 35.6 <DEGREES>
  INSTRUMENT_ELEVATION               = -15.4 <DEGREES>
END_OBJECT                            = TELEMETRY_GEOMETRY_PARAMETERS

GROUP                                = CORRECTED_GEOMETRY_PARAMETERS
  GEOMETRY_SOURCE_ID                 = "MIPS_MPFMOS"
  INSTRUMENT_AZIMUTH                 = 35.9 <DEGREES>
  INSTRUMENT_ELEVATION               = -15.5 <DEGREES>
END_OBJECT                            = CORRECTED_GEOMETRY_PARAMETERS

GROUP                                = CORRECTED_GEOMETRY_PARAMETERS
  GEOMETRY_SOURCE_ID                 = "UOFA-BACKLASH"
  INSTRUMENT_AZIMUTH                 = 35.8 <DEGREES>
  INSTRUMENT_ELEVATION               = -15.6 <DEGREES>
END_OBJECT                            = CORRECTED_GEOMETRY_PARAMETERS

```

In the near term, the only validation requirements for GROUPs will be that all the elements present in a GROUP must be present in the PDS Data Dictionary. In the future, it is hoped that the contents of the GROUPs will also be validated against their generic GROUP specifications. This would be to ascertain that all the required elements of a particular GROUP are present and that no elements are present that are not specified in the set of required and optional elements.

**groups**

- generic, 13-3
  - example, 13-3, 13-5
- implementation, 13-4
- specific, 13-3
- standard groups, 13-1
- using, 13-3

**objects**

- generic, 13-1
  - example, 13-1
- primitive, 13-2
- specific, 13-1
  - example, 13-1
- standard objects, 13-1



# Chapter 14. Pointer Usage

Pointers are used within PDS labels to indicate the relative locations of objects in the same file and to reference external files. Pointer statements begin with a caret (“^”) and the name of a PDS object or element. The value part of the pointer statement indicates the location of the referenced information.

## 14.1 Types of Pointers

Pointer statements fall into three main categories: data location pointers, include pointers, and related information pointers.

### 14.1.1 Data Location Pointers (Data Object Pointers)

The most common use of pointers is for linking object descriptions to the actual data. The syntax of these pointers depends on whether the label is attached or detached from the data it describes. There are five forms for the value fields, as shown in these examples:

- (1)    ^IMAGE               = 12
- (2)    ^IMAGE               = 600 <BYTES>
- (3)    ^INDEX\_TABLE       = "INDEX.TAB"
- (4)    ^SERIES              = ("C100306.DAT", 2)
- (5)    ^SERIES              = ("C100306.DAT", 700 <BYTES>)

Examples (1) and (2) are pointers in attached labels. This type of pointer allows reading software to scan the label for the appropriate pointer and then skip right to the data at its location elsewhere in the file. In the first case, the data begin at record 12 of the labeled file. In the second, the data begin at byte 600.

External data files are referenced in examples (3), (4) and (5). Since these pointers occur in detached labels, they must identify a file name and (optional) offset. In example (3), the data begin at record 1 of the data file “INDEX.TAB” (i.e., no explicit offset is taken as an offset of “1”). In example (4), the data begin at record 2 of the data file, “C100306.DAT”, whereas in example (5), the data begin at byte 700.

### 14.1.2 Include Pointers

Another common use of pointers is to reference external files in PDS labels or catalog objects. Files referenced by include pointers are included directly at the location of the pointer statement. These pointers are classified as include -type pointers since they act like the “#include” statements in C program source files. STRUCTURE, CATALOG, and MAP\_PROJECTION pointers fall into this category. Following are some examples of include pointer statements:

- (1)    ^STRUCTURE = "ENGTAB.FMT"
- (2)    ^STRUCTURE = "IMAGE.FMT"

- (3) ^CATALOG = "CATALOG.CAT"
- (4) ^DATA\_SET\_MAP\_PROJECTION = "DSMAPDIM.CAT"

The structure file in example (1) is referenced by a TABLE object. The "ENGTAB.FMT" file contains column object definitions needed to complete the TABLE definition. Some column definitions might be stored in a separate file if, for example, a number of different TABLE objects use the same definitions. Similarly, in example (2) an IMAGE object definition (i.e., all statements beginning with "OBJECT = IMAGE" and ending with "END\_OBJECT = IMAGE") is contained in an external file called "IMAGE.FMT".

In example (3), the external file "CATALOG.CAT" is referenced by a VOLUME object in order to provide a full set of catalog information associated with the volume without having to duplicate definitions that already exist in the other file.

In example (4), the external file "DSMAPDIM.CAT" is referenced by an IMAGE\_MAP\_PROJECTION object to complete the map projection information associated with the image.

### 14.1.3 Related Information Pointers (Description Pointers)

The third and final use of pointers occurs in PDS labels that reference external files of additional documentation of special use to human readers. These pointers are formed using elements that end in "DESCRIPTION" or "DESC". They reference text files not written in ODL. Note: These pointers are *not* meant to be used to refer to software tools.

For example:

```
^DESCRIPTION = "TRK_2_25.ASC"
```

In this example, the pointer references an external ASCII document file, TRK\_2\_25.ASC, which provides a detailed description of the data. Note that in this case the documentation file must have its own PDS label, since the label containing the ^DESCRIPTION pointer describes the contents of a different file.

## 14.2 Rules for Resolving Pointers

Following are the rules for resolving pointer references to external files (see the *Volume Organization and Naming* chapter in this document for information about physical and logical volume structures):

For a pointer statement in FILE\_A:

- (1) Look in the same directory as FILE\_A
- (2a) For a single physical volume (no logical volumes), look in the following top level directory:

Pointer	Directory
^STRUCTURE	LABEL
^CATALOG	CATALOG
^DATA_SET_MAP_PROJECTION	CATALOG*
^INDEX_TABLE	INDEX
^DESCRIPTION or ^TEXT	DOCUMENT

- (2b) Within a logical volume, look in the top level subdirectory specified by the LOGICAL\_VOLUME\_PATH\_NAME keyword:

Pointer	LOGICAL_VOLUME_PATH_NAME / Directory
^STRUCTURE	LABEL
^CATALOG	CATALOG
^DATA_SET_MAP_PROJECTION	CATALOG*
^INDEX_TABLE	INDEX
^DESCRIPTION or ^TEXT	DOCUMENT

\* Note: For volumes using PDS Version 1 or 2 standards, the MAP\_PROJECTION files may be located in the LABEL directory

All pointers to data objects should be resolved in step (1), since these files are always required to be located in the same directory as the label file.

data pointers, 14-1

description pointers, 14-2

include pointers, 14-1

pointers

- data, 14-1

  - in attached labels, 14 -1

  - in detached labels, 14 -1

- description, 14-2

- include, 14-1

- rules for resolving, 14-3

- use in labels, 14 -1

# Chapter 15. Record Formats

The choice of proper record format for a data file is influenced by a number of factors. In general, the PDS strongly recommends a record format of fixed-length or stream be used whenever possible to ensure transportability across operating systems and computer platforms and to avoid potential difficulties with interpretation of the underlying data. Records of type `FIXED_LENGTH` are required for ASCII files described by TABLE Objects. Records of type `VARIABLE_LENGTH` may be used in cases where storage efficiency is a major consideration, as, for example, in storing compressed images. Records of type `STREAM` should be used for text files for ease of transportation to various computer systems. Input/output operations with stream files will generally use string-oriented access, retrieving one delimited record from the file each time.

The `RECORD_TYPE` element in the PDS label indicates the format of the records in the associated data file (attached or detached).

**Table 15.1: Recommended Record Formats**

	<code>RECORD_TYPE=FIXED_LENGTH</code>	<code>RECORD_TYPE=STREAM</code>	<code>RECORD_TYPE=VARIABLE</code>
Data format	BINARY, ASCII	ASCII	BINARY
Environment	STRUCTURED	AD HOC	STRUCTURED (VAX/VMS)
Data volume	LARGE	SMALL, MEDIUM	VERY LARGE
Input / Output	READ / WRITE	STRING I/O	CUSTOM, SPICE

## 15.1 `FIXED_LENGTH` Records

Records of type `FIXED_LENGTH` normally use a physical record length (`RECORD_BYTES`) that corresponds directly to the logical record length of the data objects (that is, one physical record for each image line, or one physical record for each row of a table). In some cases, logical records are blocked into larger physical records to provide more efficient storage and access to the data. This blocking is still an important consideration when storing data on magnetic tape, (which requires a gap on the tape between records), but is not generally a consideration in data sets stored on magnetic or CD-ROM disks. In other cases, the physical record length is determined by compatibility with external systems or standards, as in FITS-formatted files.

The PDS strongly recommends using a physical record length that matches the logical record length of the primary data object in the file for greatest compatibility with application software. In the data label, `RECORD_BYTES` defines the physical record length.

Figure 15.1 illustrates the physical and logical structure used to build a standard PDS `FIXED_LENGTH` file.

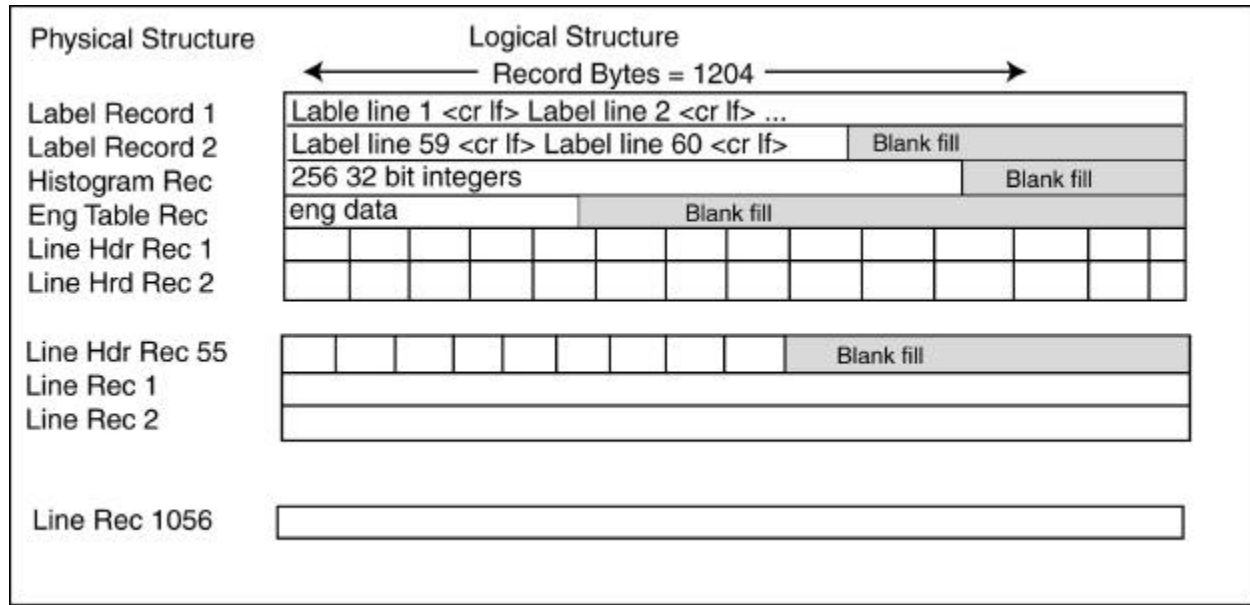

*Figure 15.1 Physical and Logical Structure for Fixed Length Files*

## 15.2 STREAM Records

The STREAM record type is reserved for ASCII text files. The records must be delimited by the two-character (carriage return, linefeed) sequence (“<CR><LF>” or “CR/LF”). This is the same record delimiter used for all PDS label and catalog files.

All major operating systems recognize one of either the carriage return, the line feed, or the CR/LF sequence as an ASCII record delimiter; thus, <CR><LF> will work in all cases. There are utilities available for Macintosh (*Apple File Exchange*) and Unix (*tr* translation utility) systems to remove the unneeded extra control character.

Note that the STREAM record type should only be used in those cases where the data contain delimited ASCII records that are *not* of fixed length. The FIXED\_LENGTH specification should be used wherever possible.

## 15.3 VARIABLE\_LENGTH Records

PDS data files using the VARIABLE\_LENGTH record type must use the VAX/VMS counted byte string format. That is, each record string is preceded by a two-byte LSB integer containing the length of the record. The records may not contain carriage control characters.

The use of the VARIABLE\_LENGTH record type is discouraged because of its inherent dependence on *a priori* knowledge of the record structure for proper reading and writing. Notwithstanding, VARIABLE\_LENGTH records may be used in the following circumstances:

- ?? When supporting software, which can be executed on a variety of hosts, is provided along with the data. For example, the Voyager CD-ROM disks contain variable-length

compressed images along with a decompression program that can be compiled and executed on VAX, PC, Macintosh and UNIX platforms. The decompression program reformats the data into a variety of forms.

- ?? When the files are intended for use only in a specific environment that supports the selected record structure. For example, the Viking Infrared Thermal Mapper (IRTM) CDROM uses a VAX/VMS variable-length record format for software and command files. Note, however, that such proprietary formats are generally inappropriate for PDS deep archiving purposes and should be vigorously avoided in archive volumes.

## 15.4 UNDEFINED Records

Records with an undefined record type have no specific record structure. For files with attached labels, the label portion should be written using the STREAM conventions described above. When the record type is designated UNDEFINED, no record terminators are recognized and no record length is implied; the data are taken to be a continuous stream of bytes.

The use of the UNDEFINED record type when referring to a single data file is strongly discouraged. "RECORD\_TYPE = UNDEFINED" is properly used in cases where a single label points to two or more *different* data files with different record types (i.e., one file with STREAM records and another with VARIABLE\_LENGTH records).

ASCII text files

record format, 15-2

data files

record format, 15-1

record formats, 15-1

blocking, 15-1

FIXED\_LENGTH, 15-1

STREAM, 15-2

UNDEFINED, 15-3

VARIABLE\_LENGTH, 15-2

VAX counted byte strings, 15-2

RECORD\_TYPE, 15-1

STREAM, 15-2

UNDEFINED, 15-3

VARIABLE\_LENGTH, 15-2



# Chapter 16. SFDU Usage

This standard defines restrictions on the use of Standard Formatted Data Units (SFDUs) in archive quality data sets. PDS does not require that data products be packaged as SFDUs. However, if data products are packaged as SFDUs, the following standards apply.

The Consultative Committee for Space Data Systems (CCSDS) has prepared a recommendation for the standardization of the structure and construction rules of SFDUs for the interchange of digital space-related data. An SFDU is a *type-length-value* object. That is, each SFDU consists of: a type identifier which indicates the type of data within the SFDU; a length field which either states the length of the data or indicates how the data are delimited; and a value field which contains the actual data. Both the type and the length fields are included in a 20-byte label, called an *SFDU label* in this document. The value field immediately follows the 20-byte SFDU Label. For PDS data products, this value field is the PDS label, including one or more data object definitions.

There are three versions of SFDUs. In Version 1, the length of an SFDU is represented in binary. In Version 2, the length could also be represented in ASCII. In Version 3, the length can be represented in binary, ASCII, or using one of several delineation techniques. Unless previously negotiated, all PDS data products packaged as SFDUs must be constructed using Version 3 SFDU Labels.

A Version 3 SFDU label consists of the following parts:

1)	Control Authority ID	4 Bytes
2)	Version ID	1 Byte
3)	Class ID	1 Byte
4)	Delimiter Type	1 Byte
5)	Spare	1 Byte
6)	Description Data Unit ID	4 Bytes
7)	Length	8 Bytes

The Control Authority ID and the Description Data Unit ID together form an identifier called an Authority and Description Identifier which points to a semantic (Planetary Science Data Dictionary, in the PDS case) and syntactic (Object Definition Language, 2.0) description of the value field. The Data Description Unit ID varies by data product type. It is supplied by the JPL Control Authority and is usually documented in the science data product Software Interface Specifications (SIS).

Version 3 allows delimiting of SFDUs either by end-of-file or by start and end markers rather than by explicit byte counts. Further details of the SFDU architecture will not be discussed here. Other sources of information can be found in the *SFDU References* listed in the *Introduction* to this document.

Since archive quality data sets are internally defined, only a limited set of SFDU labels are used to identify the files on a data volume in order to simplify not only the archive products themselves, but also the processing of those products by software. PDS labels are included in the data products, and the information in these PDS labels are considered more than adequate for data identification and scientific analysis.

PDS does not require SFDU labels in its archive products. However, SFDU labels can be accommodated in PDS products when they are required by projects or other agencies concerned in the preparation of the data. The standard use of SFDUs in PDS labels from current missions and data restorations is different from the use of SFDUs in data products from upcoming missions fully supported by the Jet Propulsion Laboratory's Advanced Multi-Mission Operations System (AMMOS). The following sections define the standards for including SFDUs in each case.

Two SFDU organizations are allowed in PDS data products. The first organization (the ZI Structure) has been used historically in PDS data products from restoration and past missions. The second organization (the ZKI organization) is required for data products that pass through the JPL Advanced Multi-Mission Operations System (AMMOS) project database.

## 16.1 The ZI SFDU Organization

Any PDS data products packaged as SFDUs that are not required to pass through the AMMOS project database as part of an active mission may use the following SFDU organization.

Each instance of a data product (file) in a data set must include two (and only two) SFDU labels. These are a Z Class SFDU label and an I Class SFDU label. The two SFDU labels are concatenated (i.e. Z, then I) and left justified in the first line or record of the PDS label for each data product. (See Figure 16.1.) In the case of data products with detached PDS labels, the two SFDU labels must appear in the first record of the PDS label files and no SFDU labels appear in the data object files. (See Figure 16.2.)

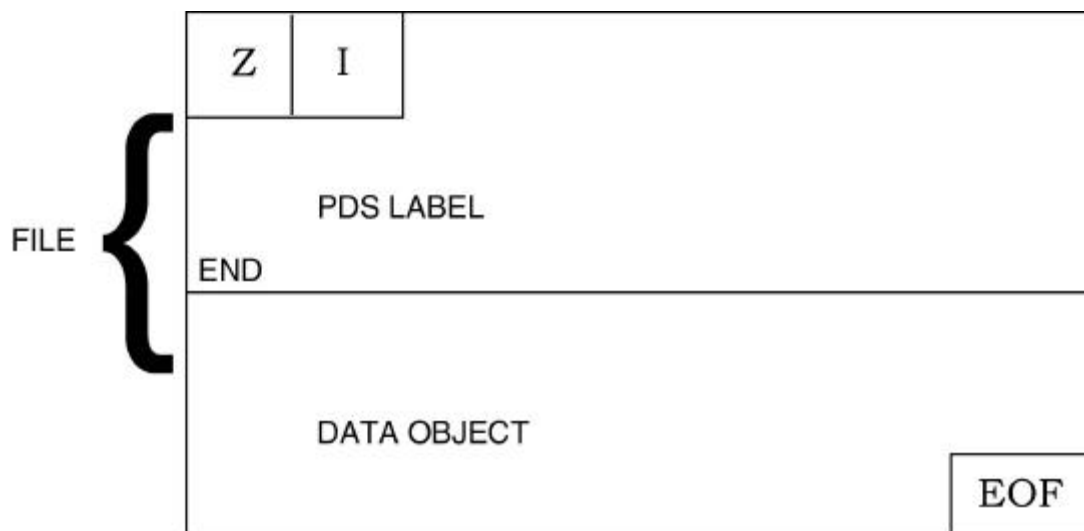

**Figure 16.1 Attached PDS Label Example for non-AMMOS compatible products**

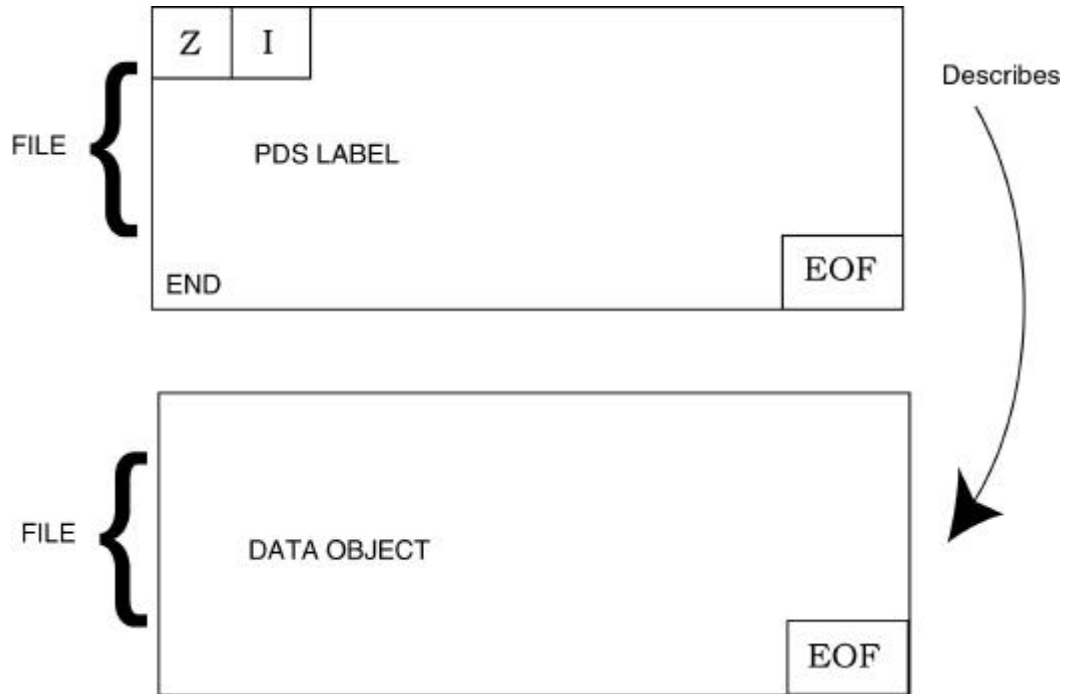

**Figure 16.2 Detached PDS Label Example for non-AMMOS compatible products**

The first SFDU label must be a Z Class Version 3 SFDU label. “Z Class” indicates that the value field (everything after the first 20 bytes) is an aggregation. In this case, the aggregation consists of only the I Class SFDU. This label also indicates that the delimiter type is End -of-File and that this SFDU (data product) is terminated by a single End -of-File. It is formed as follows:

- |    |                          |          |
|----|--------------------------|----------|
| 1) | Control Authority ID     | CCSD     |
| 2) | Version ID               | 3        |
| 3) | Class ID                 | Z        |
| 4) | Delimiter Type           | F        |
| 5) | Spare                    | 0        |
| 6) | Description Data Unit ID | 0001     |
| 7) | Length Field             | 00000001 |

Example: CCSD3ZF00001000000001

The second SFDU label must be an I Class Version 3 SFDU label. “Class I” indicates that the

value field (everything after the second 20 bytes) is application data, i.e., the PDS label and the data object(s). The Data Description Unit ID of “PDSX” indicates that the data product uses the Object Description Language (ODL) syntax and the Planetary Science Data Dictionary semantics to present descriptive information. This SFDU label also indicates that the SFDU (data products) will be terminated by a single End -of-File. It is formed as follows:

- |    |                          |          |
|----|--------------------------|----------|
| 1) | Control Authority ID     | NJPL     |
| 2) | Version ID               | 3        |
| 3) | Class ID                 | I        |
| 4) | Delimiter Type           | F        |
| 5) | Spare                    | 0        |
| 6) | Description Data Unit ID | PDSX     |
| 7) | Length Field             | 00000001 |

Example: NJPL3IF0PDSX00000001

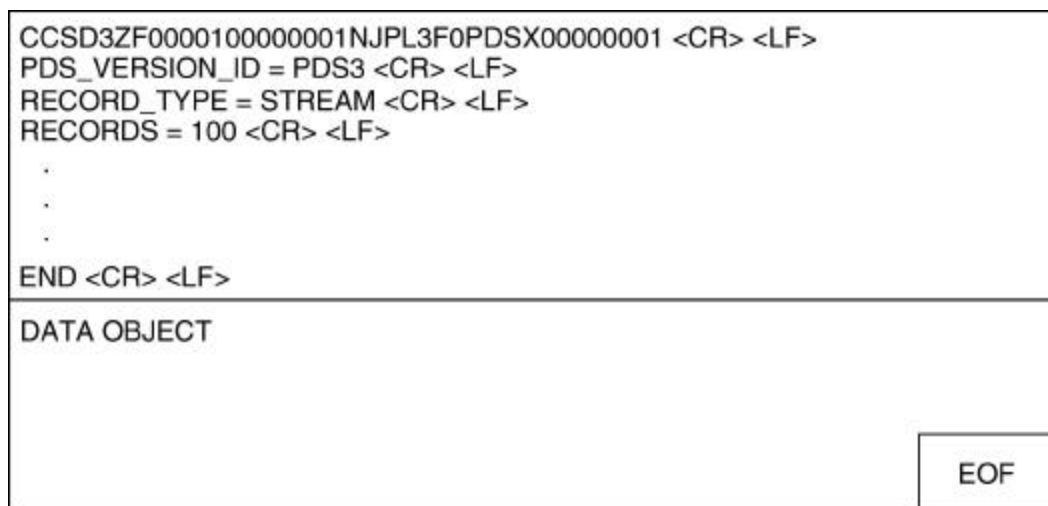

**Figure 16.3: SFDU Example**

The two SFDU labels are concatenated and left justified in the first line or record of the PDS label. Note that there are no characters between the two SFDU labels. See Figure 16.3.

For RECORD\_TYPE = STREAM or FIXED\_LENGTH or UNDEFINED, the concatenated SFDU labels must be followed immediately by <CR><LF>. For data products that have RECORD\_TYPE = VARIABLE\_LENGTH, the two SFDU labels may not be followed by <CR><LF>.

STREAM example	CCSD3ZF0000100000001NJPL3IF0PDSX00000001 <CR><LF>
FIXED_LENGTH Example	CCSD3ZF0000100000001NJPL3IF0PDSX00000001<CR><LF>
VARIABLE_LENGTH Example	CCSD3ZF0000100000001NJPL3IF0PDSX00000001
UNDEFINED Example	CCSD3ZF0000100000001NJPL3IF0PDSX00000001<CR><LF>

The remainder of the PDS label begins on the next line or record. The last line of the PDS label contains the END statement. Then, if the PDS Label is attached, the data object begins on the next record. If the PDS label is detached, the END statement is the last line of the file.

***Figure 16.4: PDS Label Example for AMMOS compatible products***

The first SFDU label must be a Z Class Version 3 SFDU label. The Z Class indicates that the value field (everything after the first 20 bytes) is an aggregation. In this case, the aggregation consists of a K Class (PDS label) and an I Class (data object) SFDU. This label also indicates that the delimiter type is End -of-File and that this SFDU (data product) is terminated by a single End-of-File. It is formed as follows:

1)	Control Authority	CCSD
2)	Version ID	3
3)	Class ID	Z
4)	Delimiter Type	F
5)	Spare	0
6)	Description Data Unit ID	0001
7)	Length Field	00000001

Example: CCSD3ZF0000I000000 0I

The second SFDU label must be a K Class Version 3 SFDU label. “Class K” indicates that the value field (everything after the second 20 bytes) is catalog and directory information, i.e., the PDS label (sometimes referred to as the K Header). The Data Description Unit ID of PDSX indicates that the PDS label uses the Object Description Language (ODL) syntax and the Planetary Science Data Dictionary semantics to present data descriptive information. The SFDU label also indicates that the SFDU is delimited by a Start-Marker/End-Marker pair. It is formed as follows:

1)	Control Authority ID	NJPL
2)	Version ID	3
3)	Class ID	K
4)	Delimiter Type	S
5)	Spare	0
6)	Description Data Unit ID	PDSX
7)	Length Field	##mark##

The marker pattern (“##mark##” in the example) can be set to any string that is unlikely to be repeated elsewhere in the data product.

Example: NJPL3KS0PDSX##mark##

The two SFDU labels must be concatenated and left justified in the first line or record of the PDS label. Note that there are no characters between the two SFDU labels. For data products with RECORD\_TYPE equal to VARIABLE\_LENGTH, the two concatenated SFDU labels must not be followed by <CR><LF>.

Example: CCSD3ZF0000I0000000INJPL3KS0PDSX##mark##

The remainder of the PDS label begins on the next line. The last line of the PDS label contains the END statement. Then, in the same line or record, right justified, is the End -Marker for the K Class SFDU and the I Class SFDU label. The End -Marker pattern must appear as:

Example: CCSD\$\$MARKER##mark##

Note that the start marker and the end marker fields must be identical within the SFDU (in the example, “##mark##”). Next must be an I Class Version 3 SFDU label. “Class I” indicates that the value field (everything after the SFDU label) is application data, i.e., the data object. The Data Description Unit ID varies by data product type. It is supplied by the JPL Control Authority and is usually documented in the science data product Software Interface Specifications (SIS). The SFDU label also indicates that the SFDU will be terminated by a single End -of-File. It is formed as follows:

1)	Control Authority ID	NJPL
2)	Version ID	3
3)	Class ID	I
4)	Delimiter Type	F
5)	Spare	0
6)	Description Data Unit ID	XXXX
7)	Length Field	00000001

Example: NJPL3IF0010600000001 (where XXXX has been replaced by 0106.)

The two SFDU labels must be concatenated, right justified, and appear in the last line or record of the PDS label following the END statement. (If it happens that there are not 40 bytes left in the last record of the PDS label, add an additional record and right justify the two SFDU labels.) Note that there are no characters between the two SFDU labels, and that the marker pattern and I Class SFDU Labels are transparent to PDS label processing software.

Example: END CCSD\$\$MARKER###mark###NJPL3IF0010600000001

The data object begins with the next physical record.

### 16.3 Examples

RECORD\_TYPE = STREAM:

End Statement blank(s)	End marker	I Class SFDU	End of record
END		CCSD\$\$MARKER###mark###NJPL3IF0010600000001	<CR><LF>

RECORD\_TYPE = FIXED\_LENGTH:

End Statement Terminator	Record Boundary
END <CR><LF> bbbbb	CCSD\$\$MARKER###mark###NJPL3IF0010600000001

RECORD\_TYPE = UNDEFINED:

	Statement terminator
End Statement	↓
END<CR><LF>	CCSD\$\$MARKER###mark###NJPL3IF0010600000001

```
RECORD_TYPE = VARIABLE_LENGTH:
```

```
    Record Length  END end of statement
```

```
    END  CCSD$$MARKER###mark##NJPL3IF0010600000001
```

## 16.4 Exceptions to this Standard

Software files and document files should not be packaged as SFDU s.

Previous versions of the PDS standards expressed the ZI SFDU labels as an ODL statement. The ZI SFDU labels were followed by “= SFDU\_LABEL”.

Example:       CCSD3ZF0000100000001NJPL3IF0PDSX00000001 = SFDU\_LABEL



END statements, 16-5

Standard Formatted Data Unit (SFDU)

  AMMOS usage, 16-5

  definition, 16-1

  examples

    FIXED\_LENGTH file, 16-7

    STREAM file, 16-7

    UNDEFINED file, 16-7

    VARIABLE\_LENGTH file, 16-8

  exceptions, 16-8

  I class, 16-2, 16-5

  K class, 16-5

  usage in PDS products, 16-1

  versions, 16-1

  Z class, 16-2, 16-5

# Chapter 17. Usage of N/A, UNK and NULL

## 17.1 Interpretation of N/A, UNK, and NULL

During the completion of data product labels or catalog files, one or more values may not be available for some set of required data elements. In this case PDS provides the symbolic literals “N/A”, “UNK”, and “NULL”, each of which is appropriate under different circumstances.

### 17.1.1 N/A

“N/A” (“Not Applicable”) indicates that the values within the domain of this data element are not applicable in this instance. For example, a data set catalog file describing NAIF SPK kernels would contain the line:

```
INSTRUMENT_ID = "N/A"
```

because this data set is not associated with a particular instrument.

“N/A” may be used as needed for data elements of any type (i.e., text, date, numeric, etc.).

### 17.1.2 UNK

“UNK” (“Unknown”) indicates that the value for the data element is not known and never will be. For example, in a data set comprising a series of images, each taken with a different filter, one of the labels might contain the line:

```
FILTER_NAME = "UNK"
```

if the observing log recording the filter name was lost or destroyed and the name of the filter is not otherwise recoverable.

“UNK” may be used as needed for data elements of any type.

### 17.1.3 NULL

“NULL” is used to flag values that are *temporarily* unknown. It indicates that the data preparer recognizes that a specific value should be applied, but that the true value was not readily available. “NULL” is a placeholder. For example, the line:

```
DATA_SET_RELEASE_DATE = "NULL"
```

might be used in a data set catalog file during the development and review process to indicate that the release date has not yet been determined.

Note that all “NULL” indicators should be replaced by their actual values prior to final archiving of the associated data.

## 17.2 Implementation Recommendations for N/A, UNK, and NULL

The figurative constants defined above require special values for storage in data base systems. The PDS has the following recommendations for software intended to support PDS labels and catalog objects:

1. In the case of character fields, the explicit string can be stored in the corresponding data elements without further modification. This approach can also be taken where date and time data types are stored as strings.
2. Numeric fields require special flag values to represent the “N/A”, “NULL” and “UNK” indicators. Table 17.1 provides suggested standard flag values for each case.

In creating index files based on element values extracted from PDS labels, there are two options for dealing with “N/A”, “NULL”, and “UNK” in non -string columns:

1. The character strings can be used explicitly in the index. Note, however, that in this case the DATA\_TYPE of the column may be forced to “CHARACTER”, since, for example, encountering the string “NULL” in what is otherwise a numeric column would cause a read failure.
2. The character strings can be replaced with an appropriate numeric constant. In this case the substitution is indicated in the corresponding column definition by including the NOT\_APPLICABLE\_CONSTANT, NULL\_CONSTANT or UNKNOWN\_CONSTANT elements as needed.

**Table 17.1: Numeric values for N/A, UNK, NULL**

<b>Signed Integer (4 byte)</b>	<b>Signed Integer (2 byte)</b>
--	--

meanings of UNK and NULL can be combined and the token or numeric representation of UNK used.

N/A constant, 17-1

Not Applicable constant, 17-1

NULL constant, 17-1

UNK constant, 17-1

Unknown constant, 17-1

# Chapter 18. Units of Measurement

The uniform use of units of measure facilitates broad catalog searches across archive systems. The PDS standard system for units, where applicable, is the *Système Internationale d'Unités* (SI). The default units for data elements in the *Planetary Science Data Dictionary* (PSDD) are determined as each element is defined and added to the dictionary. Specific unit definitions are also included in the PSDD.

In cases where more than one type of unit is commonly used for a given data element, an additional data element is provided to explicitly identify the corresponding unit. SAMPLING\_PARAMETER\_RESOLUTION and SAMPLING\_PARAMETER\_UNIT are one such pair. The PDS allows exceptions to the SI unit requirement when common usage conflicts with the SI standard (e.g., angles which are measured in degrees rather than radians).

Both singular and plural unit names, as well as unit symbols, are allowed. The double asterisk (\*\*) is used, rather than the caret (^), to indicate exponentiation. When the units associated with a value of a PDS element are not the same as the default units specified in the PSDD (or when explicit units are preferred), a unit expression is used with the value. These unit expressions are enclosed in angular brackets (< >) and follow the value to which they apply.

## *Examples*

```
EXPOSURE_DURATION = 10 <SECONDS>
DECLINATION       = -14.2756 <DEGREES>
MASS              = 123 <kg>
MASS_DENSITY     = 123 <g/cm**3>
MAP_RESOLUTION   = 123 <PIXEL/DEGREE>
MAP_SCALE        = 123 <KM/PIXEL>
```

Note that in the above example, MASS\_DENSITY is not expressed in the SI default unit of measurement for density (kg/m\*\*3).

PDS recommends (in order of preference) that measurements be expressed using the default SI units of measurements, as defined in the following paragraphs. If it is not desirable to use the

units”:

<u>QUANTITY</u>	<u>NAME OF UNIT</u>	<u>SYMBOL</u>
length	meter	m
mass	kilogram	kg
time	second	s
electric current	ampere	A
thermodynamic temperature	kelvin	K
amount of substance	mole	mol
luminous intensity	candela	cd

SI units are all written in mixed case; symbols are also mixed case except for those derived from proper names. No periods are used in any of the symbols in the international system.

*Derived units* — In addition to the base units of the system, a host of derived units, which stem from the base units, are also employed. One class of these is formed by adding a prefix, representing a power of ten, to the base unit. For example, a kilometer is equal to 1,000 meters, and a millisecond is .001 (that is, 1/1,000) second. The prefixes in current use are as follows:

<b>SI PREFIXES</b>					
<u>Factor</u>	<u>Prefix</u>	<u>Symbol</u>	<u>Factor</u>	<u>Prefix</u>	<u>Symbol</u>
10**18	exa	E	10**-1	deci	d
10**15	peta	P	10**-2	centi	c
10**12	tera	T	10**-3	milli	m
10**9	giga	G	10**-6	micro	
10**6	mega	M	10**-9	nano	n
10**3	kilo	k	10**-12	pico	p
10**2	hecto	h	10**-15	femto	f
10**1	deka	da	10**-18	atto	a

Note that the kilogram (rather than the gram) was selected as the base unit for mass for historical reasons. Notwithstanding, the gram is the basis for creating mass units by addition of prefixes.

Another class of derived units consists of powers of base units and of base units in algebraic relationships. Some of the more familiar of these are the following:

<u>QUANTITY</u>	<u>NAME OF UNIT</u>	<u>SYMBOL</u>
area	square meter	m**2
volume	cubic meter	m**3
density	kilogram per cubic meter	kg/m**3
velocity	meter per second	m/s
angular velocity	radian per second	rad/s
acceleration	meter per second squared	m/s**2

angular acceleration	radian per second squared	$\text{rad/s}^2$
kinematic viscosity	square meter per second	$\text{m}^2/\text{s}$
dynamic viscosity	newton-second per square meter	$\text{N}\cdot\text{s}/\text{m}^2$
luminance	candela per square meter	$\text{cd}/\text{m}^2$
wave number	1 per meter	$\text{m}^{-1}$
activity (of a radioactive source)	1 per second	$\text{s}^{-1}$

Many derived SI units have names of their own:

<u>QUANTITY</u>	<u>NAME OF UNIT</u>	<u>SYMBOL</u>	<u>EQUIVALENT</u>
frequency	hertz	Hz	$\text{s}^{-1}$
force	newton	N	$\text{kg}\cdot\text{m}/\text{s}^2$
pressure (mechanical stress)	pascal	Pa	$\text{N}/\text{m}^2$
work, energy, quantity of heat	joule	J	$\text{N}\cdot\text{m}$
power	watt	W	$\text{J}/\text{s}$
quantity of electricity potential difference	coulomb	C	$\text{A}\cdot\text{s}$
electromotive force	volt	V	$\text{W}/\text{A}$
electrical resistance	ohm	—	$\text{V}/\text{A}$
capacitance	farad	F	$\text{A}\cdot\text{s}/\text{V}$
magnetic flux	weber	Wb	$\text{V}\cdot\text{s}$
inductance	henry	H	$\text{V}\cdot\text{s}/\text{A}$
magnetic flux density	tesla	T	$\text{Wb}/\text{m}^2$
luminous flux	lumen	lm	$\text{cd}\cdot\text{sr}$
illuminance	lux	lx	$\text{lm}/\text{m}^2$

Supplementary units are as follows:

<u>QUANTITY</u>	<u>NAME OF UNIT</u>	<u>SYMBOL</u>
plane angle	radian	rad
solid angle	steradian	sr

*Use of figures with SI units* — In the international system it is considered preferable to use only numbers between 0.1 and 1,000 in expressing the quantity associated with any SI unit. Thus the quantity 12,000 meters is expressed as “12 km”, not “12,000 m”. So too, 0.003 cubic centimeters is preferably written “3 mm<sup>3</sup>”, not “0.003 cm<sup>3</sup>”.



SAMPLING\_PARAMETER\_RESOLUTION, 18-1

SAMPLING\_PARAMETER\_UNIT, 18-1

Systeme Internationale d'Unites (SI), 18-1

units of measure, 18-1

    default units, 18-1

    SI prefixes, 18-2

    SI units, 18-1

    supplementary units, 18-3

    symbols, 18-1

# Chapter 19. Volume Organization and Naming

The *Volume Organization and Naming* Standard defines the organization of data sets onto physical media and the conventions for forming volume names and identifiers. A *volume* is one unit of a physical medium such as a CD, a DVD, or a magnetic tape. Data sets may reside on one or more volumes and multiple data sets may also be stored on a single volume. Volumes are grouped into *volume sets*.

Each volume has a directory structure containing subdirectories and files. Both random access (CD, DVD) and sequential access (magnetic tape) media are supported. A PDS volume on a sequential access medium has a virtual directory structure defined in the VOLUME object included in the file “VOLDESC.CAT”. This virtual structure may then be used to recreate the volume directory structure when the files are moved to a random access medium.

PDS recommends that the entire contents of an archive volume and volume set be based on a single version of the PDS Standards Reference. Software tools that work with one version of the Standards may not work with all versions.

## 19.1 Volume Set Types

Data may be organized into one of four types of archive volumes, based on the number of data sets on each volume and the number of volumes required to capture all the data. The directory organization of the volumes and the required files varies slightly depending on this volume type. Figures 19.1 through 19.4 depict the various volume directory structure options. The four volume types are described below.

1. *One data set on one volume.* This basic volume organization is illustrated in Figure 19.1. The required and optional files and directories are detailed in Section 19.3.
2. *One data set on many volumes.* In this case the INDEX subdirectory includes both local indices, for the data on the present volume, and cumulative indices, for the data on all (preceding) volumes. This layout is illustrated in Figure 19.2.
3. *Many data sets on one volume.* In this case, additional file naming conventions are imposed to prevent collisions; data subdirectories are organized by data set. There are two variations on this scheme:
  - a. *One logical volume* – That is, the data sets collected on the physical medium constitute a single logical volume and would generally be distributed together. See Figures 19.3a and 19.3b, and Section 19.6 for more information on logical volumes.
  - b. *Many logical volumes* – and The physical medium contains several largely independent collections of data sets, with each collection organized as though it were on its own volume. This is useful when a larger capacity medium (say, DVD) is being used to hold several volumes originally produced on a smaller

capacity medium (e.g., CD-ROM). In this case, directories that are common to and identical on all volumes need only be reproduced once (e.g., the SOFTWARE directory in Figure 19.3b). See Figures 19.3a and 19.3b, and Section 19.6 for more information on logical volumes.

4. *Many data sets on many volumes.* This organization is most useful when several large data sets are being produced in parallel over an extended period of time (as with some space missions). Sections of each data set appear on each physical volume, requiring additional naming considerations. See Figure 19.4 for more information.

Note that it is possible to have one or more volumes containing only data accompanied by an ancillary volume containing the DOCUMENT, CATALOG, GAZETTER, SOFTWARE, CALIB, and GEOMETRY directories relevant to all the other volumes. When this is done, the PDS requires that all files referenced by include-type pointers (see the *Pointer Usage* chapter in this document) be present on the data volume. The PDS recommends that ancillary files be archived on the same volume as the corresponding data wherever possible, to facilitate science access.

The contents and organization of the directories of all the volume types are described in the remainder of this chapter.

VOLUME SET ORGANIZATION STANDARD  
ONE DATA SET, ONE VOLUME

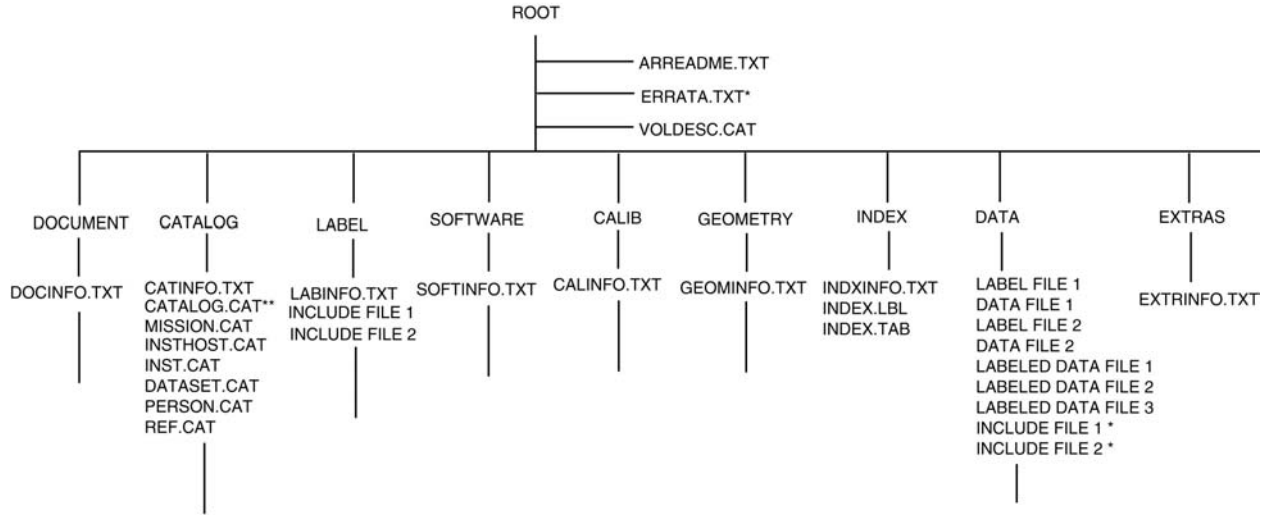

xxxxINFO.TXT Required for each non-data subdirectory if present  
 \* Optional  
 \*\* Individual catalog files are preferred, or they may be combined in a single CATALOG.CAT file.

**Figure 19.1 Volume Set Organization Standard - One Data Set, One Volume**

**VOLUME SET ORGANIZATION STANDARD  
ONE DATA SET, MANY VOLUMES**

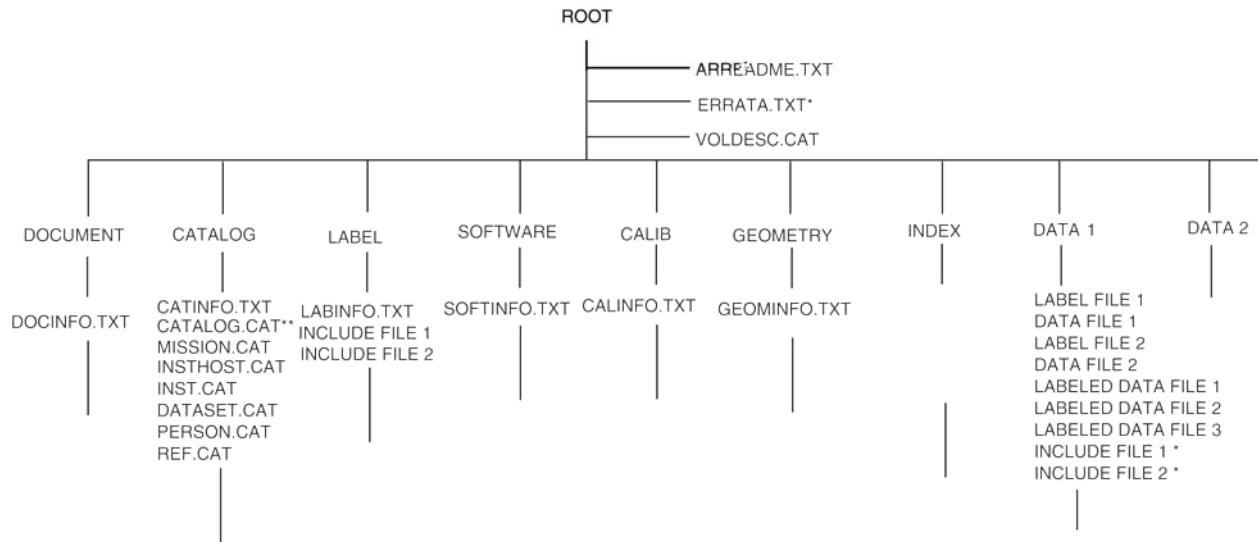

xxxxINFO.TXT Required for each non-data subdirectory if present

\* Optional

\*\* Individual catalog files are preferred, or they may be combined in a single CATALOG.CAT file.

***Figure 19.2 Volume Set Organization Standard - One Data Set, Many Volumes***

VOLUME SET ORGANIZATION STANDARD  
MANY DATA SETS, ONE VOLUME

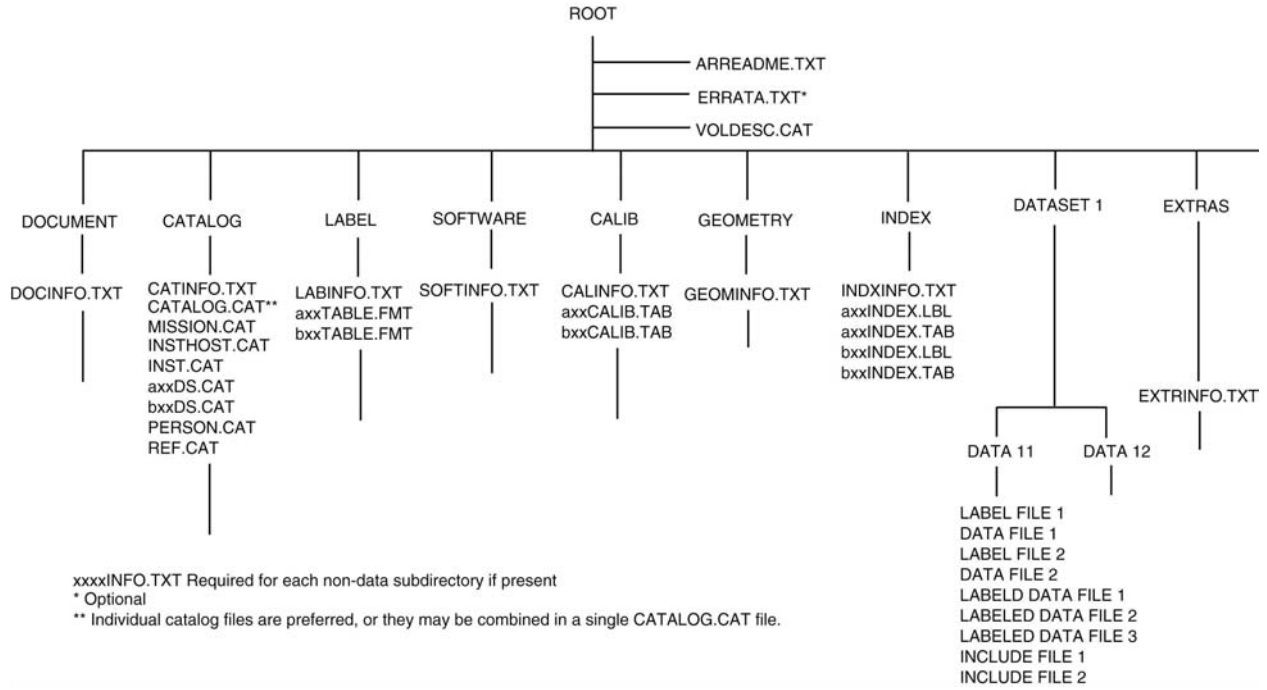
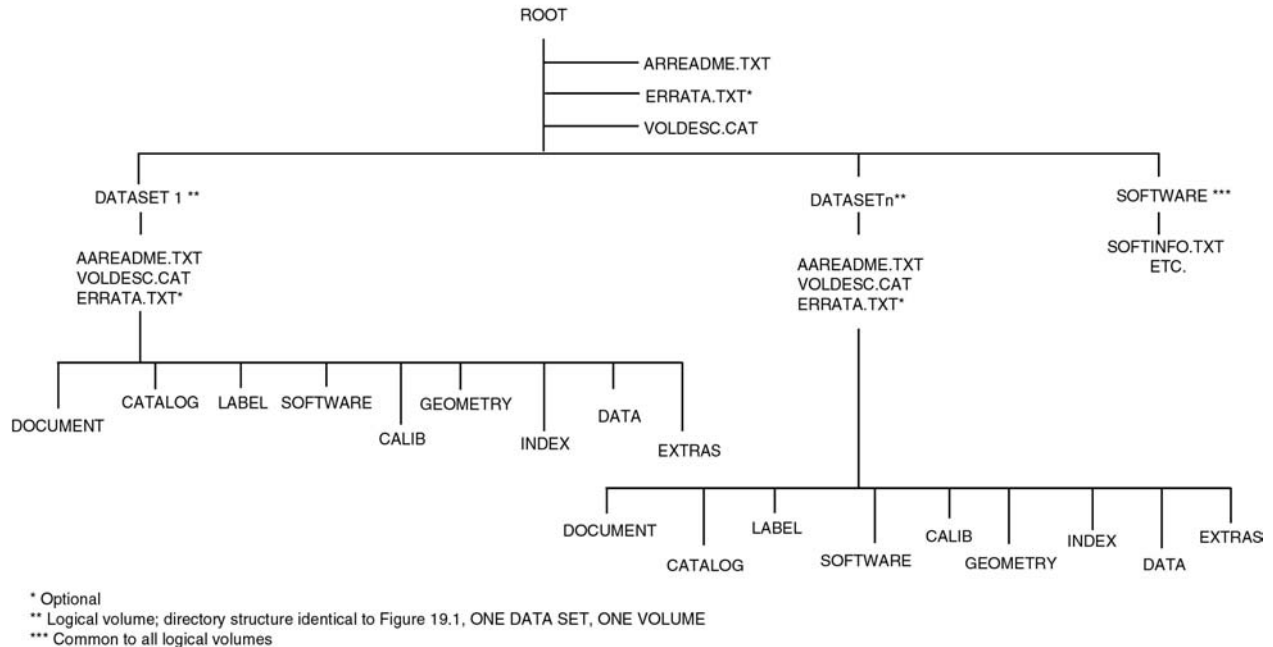

Figure 19.3a Volume Set Organization Standard - Many Data Sets, One Volume

VOLUME SET ORGANIZATION STANDARD  
 MANY DATA SETS, ONE PHYSICAL VOLUME,  
 MANY LOGICAL VOLUMES



**Figure 19.3b** *Volume Set Organization Standard - Many Data Sets, One Physical Volume, Many Logical Volumes*

**VOLUME SET ORGANIZATION STANDARD  
MANY DATA SETS, MANY VOLUMES**

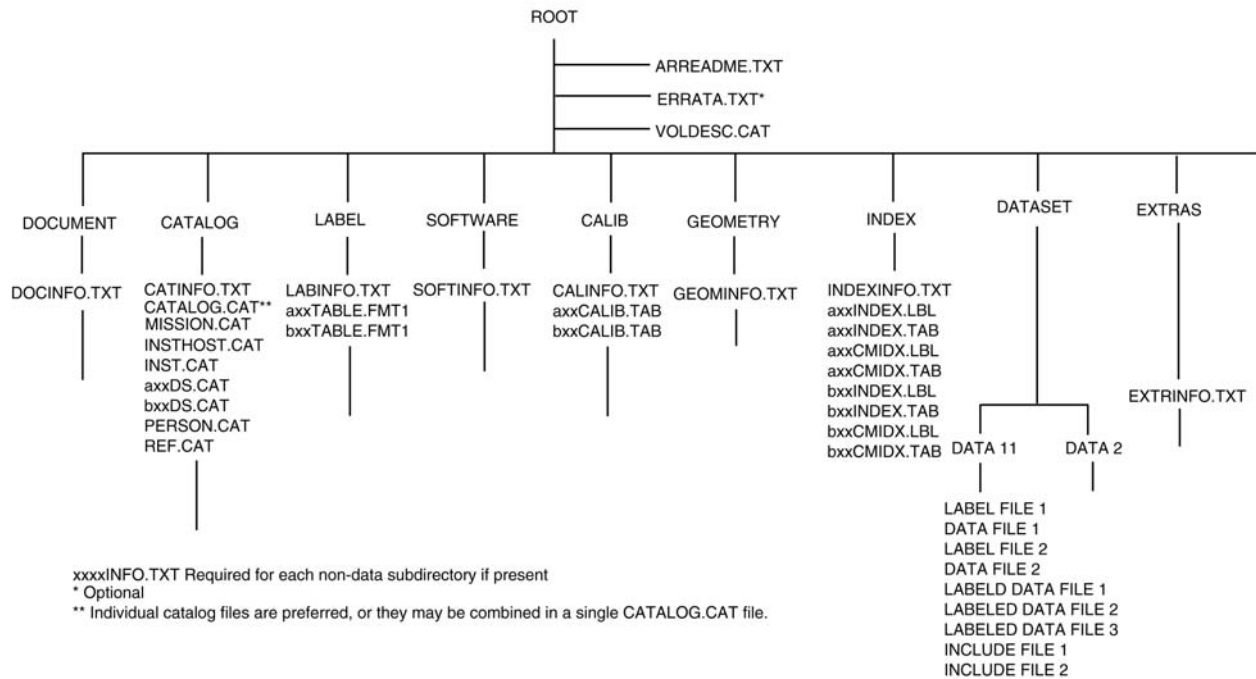

*Figure 19.4 Volume Set Organization Standard - Many Data Sets, Many Volumes*

## 19.2 Volume Organization Guidelines

The PDS recommends that directory structures be simple, path names short, and directory and file names constructed in a logical manner. When determining the number of files to be stored in each subdirectory, data preparers should keep in mind that most users rely on visual inspection to glean the contents of a directory or confirm that a disk is intact. Note that some older operating systems will “crash” when encountering a directory containing more than 128 files. Note also that device load time can be directly dependent on the number of files in a directory, making large directories inconvenient for large numbers of users. The typical practical limit for these purposes is on the order of 100 files per directory. As a further convenience to users, PDS recommends that empty subdirectories be omitted entirely.

## 19.3 Description of Directory Contents and Organization

The root directory is the top-level directory of a volume. The following sections describe the contents of the root directory, followed by the contents of the required subdirectories (in alphabetical order), and finally the contents of the optional directories (in alphabetical order).



### 19.3.1 ROOT Directory Files

#### **AAREADME.TXT**

**Required**

This file contains an overview of the contents and organization of the associated volume, general instructions for its use, and contact information. The name has been chosen so that it will be listed first in an alphabetical directory listing. See Appendix D for an example of an AAREADME.TXT file.

#### **VOLDESC.CAT**

**Required**

This file contains the VOLUME object, which gives a high-level description of the contents of the volume.

#### **ERRATA.TXT**

**Optional**

This file identifies and describes errors and/or anomalies found in the current volume, and possibly in previous volumes of a set. When a volume contains known errors they must be documented in this file.

#### **VOLDESC.SFD**

**Obsolete**

*This file is identified here only for backward compatibility with previous versions of the PDS standards. It is not to be used in current archive products.*

This file contains the SFDU reference object structure that aggregates the separate file contents of the volume into an SFDU. The reference object itself is expressed in ODL. This file should only be included if the data products are packaged as SFDUs. (Note the “.SFD” file extension is a reserved file extension in the CCSDS SFDU standard indicating the file contains a valid SFDU.)

### 19.3.2 Required Subdirectories

#### 19.3.2.1 CATALOG Subdirectory

This subdirectory contains the catalog object files (for the mission, instrument, data sets, etc.) for the entire volume. When several logical volumes are present on a single physical volume, each logical volume should have its own CATALOG subdirectory.

#### **CATINFO.TXT**

**Required**

This file identifies and describes the function of each file in the CATALOG subdirectory.

#### **CATALOG.CAT**

**Optional**

In most cases, the individual catalog objects are in separate files, one for each object. On some older archive volumes, however, all catalog objects were collected into a single file called CATALOG.CAT.

### ***PDS Methodology for Supplying Catalog Objects***

The preferred method for supplying catalog objects is as separate files for each catalog object, since this facilitates the review, verification and archiving process. In Figure 19.5, for example, the files *axxxxx*DS.CAT and *bxxxxx*DS.CAT represent two separate files each containing single data set catalog objects (descriptive information about the data set) for data sets *a* and *b* respectively. See the *File Specification and Naming* chapter in this document for the file naming rules; see Section A.5, CATALOG, for the required contents of the catalog object, and see *Appendix B* for information on each of the referenced catalog objects.

When catalog objects are organized in separate files or sets of files, pointer expressions shall be constructed according to the following table. Under "File Name", the first line shows the file name to be used if a single catalog file is present on the volume for the particular type of catalog object named. The second shows the syntax and file name convention to be followed if multiple catalog files are present for the named object.

<b>Catalog Pointer Name</b>	<b>File Name</b>
^DATA_SET_CATALOG	= "DATASET.CAT" = {"xxxxxxDS.CAT","yyyyyyDS.CAT"}
^DATA_SET_COLLECTION_CATALOG	= "DSCOLL.CAT" = {"xxxxxDSC.CAT","yyyyyDSC.CAT"}
^DATA_SET_MAP_PROJECTION_CATALOG	= "DSMAP.CAT" = {"xxxDSMAP.CAT","yyyDSMAP.CAT"}
^INSTRUMENT_CATALOG	= "INST.CAT" = {"xxxxINST.CAT","yyyyINST.CAT"}
^INSTRUMENT_HOST_CATALOG	= "INSTHOST.CAT" = {"xxxxHOST.CAT","yyyyHOST.CAT"}
^MISSION_CATALOG	= "MISSION.CAT" = {"xxxxxMSN.CAT","yyyyyMSN.CAT"}
^PERSONNEL_CATALOG	= "PERSON.CAT" = {"xxxxPERS.CAT","yyyyPERS.CAT"}
^REFERENCE_CATALOG	= "REF.CAT" = {"xxxxxREF.CAT","yyyyyREF.CAT"}
^SOFTWARE_CATALOG	= "SOFTWARE.CAT" = {"xxxSW.CAT","yyySW.CAT"}
^TARGET_CATALOG	= "TARGET.CAT" = {"xxxTGT.CAT","yyyTGT.CAT"}

### **19.3.2.2 Data Subdirectory**

The DATA subdirectory may be used to unclutter the root directory of a volume by providing a single entry point to multiple data subdirectories. These directories contain the data product files. The directories are organized and named according to the standards in Chapter 8, *Directory Types and Naming*, in this document. Subdirectories may be nested up to eight levels deep on a physical volume.

## Data Files

A data file contains one or more data objects, which is a grouping of data resulting from a scientific observation (such as an image or table) and representing the measured instrument parameters.

## Label Files

A label file contains a detached PDS label that identifies, describes, and defines the structure of the data objects. The associated data objects are contained in an accompanying data file. The label file must have the same base name as the associated data file, with an extension of “.LBL”.

## Labeled Data Files

PDS labels may be attached directly to the data they describe. In this case the PDS label comes first and the data begin immediately following the end of the label. When attached labels are used, no “.LBL” files will be present in the data directories. See the *Data Products* and *Data Product Labels* chapters in this manual for details.

### 19.3.2.3 INDEX Subdirectory

This directory contains the indices for all data products on the volume.

*Note:* If the physical volume is organized as several logical volumes (case 3b of Section 19-1), there will generally not be an INDEX subdirectory at the root of the physical volume. Instead there will be individual INDEX subdirectories at the root of each logical volume. See Section A.20, INDEX\_TABLE, for more information.

#### INDXINFO.TXT

**Required**

This file identifies and describes the function of each file in the INDEX subdirectory. This description should include at least:

- 1) A description of the structure and contents of each index table in this subdirectory
- 2) Usage notes

For an example of the INDXINFO.TXT file, see Appendix D, Section D.2.

#### INDEX.LBL

**Required**

This is the PDS label for the volume index file, INDEX.TAB. The INDEX\_TABLE specific object should be used to identify and describe the columns of the index table. See *Appendix A* for an example. Although INDEX.LBL is the preferred name for this file, the name *axxINDEX.LBL*

may also be used (with *axx* replaced by an appropriate mnemonic).

Note: The PDS recommends detached labels for index tables. If an attached label is used, this file is omitted.

## **INDEX.TAB**

**Required**

This file contains the volume index in tabular format (i.e., the INDEX\_TABLE specific object is used to identify and describe the data stored on an archive volume). Only data product label files (i.e., not the data files) are included in an index table. In rare cases, however, ancillary files are also included. Although INDEX.TAB is the preferred name for this file, the name *axx*INDEX.TAB may also be used, with *axx* replaced by an appropriate mnemonic.

Note that the *axx* prefix is neither required nor recommended. Data producers may use a prefix to distinguish two or more files by data set, instrument, or other criteria. The data producer should replace the generic prefixes shown here with a suitable mnemonic.

*The following files are recommended for multi-volume sets:*

## **CUMINDEX.LBL**

**Optional**

This file contains the cumulative volume set index in tabular format (i.e., the INDEX\_TABLE specific object is used to identify and describe the data stored on each archive volume). Only data product label files (i.e., not the data files) are included in an index table. In rare cases, however, ancillary files may be included. Although CUMINDEX.LBL is the preferred name for this file, the name *axx*CMIDX.LBL may also be used, with *axx* replaced by an appropriate mnemonic.

PDS recommends the use of detached labels for index tables. If an attached label is used, this file is omitted.

## **CUMINDEX.TAB**

**Optional**

This file contains the cumulative volume set index in a tabular format. Normally only data files are included in a cumulative index table. In some cases, however, ancillary files may be included. Although CUMINDEX.TAB is the preferred name for this file, the name *axx*CMIDX.TAB may also be used, with *axx* replaced by an appropriate mnemonic.

### **19.3.3 Optional Subdirectories**

#### **19.3.3.1 CALIBration Subdirectory**

This directory contains the calibration files used in the processing of the raw data or needed to use the data products on the volume. Note that “CALIB” is only a recommended name - a different directory name may be used if appropriate.

**CALINFO.TXT****Required**

This file identifies and describes the function of each file in the CALIB subdirectory.

**Calibration Files****Required**

In Figures 19.3 and 19.5, the files *axx*CALIB.TAB and *bxx*CALIB.TAB represent sample files. The *axx* and *bxx* prefixes indicate that the calibration files for different data sets (*a* and *b*) may be combined in the same CALIB subdirectory.

Note that the *axx* and *bxx* prefixes in the sample names are neither required nor recommended. Data producers may use them to distinguish two or more files (by data set, instrument, or other criteria). Also, in this case the “CALIB” file name is not required. It is used in the figures to differentiate calibration files from observational data files. The data producer should replace the generic file names shown here by suitably mnemonic names.

**19.3.3.2 DOCUMENT Subdirectory**

in the Planetary Science Data Dictionary (PSDD). The PDSDD.IDX is an index of the PDSDD.FUL and is currently used by the PDS validation tools to quickly locate individual elements in the PSDD.

These files are human-readable ASCII text and are useful for (future) users to ascertain the data object and data element definitions used within the PDS at the time that the archive product was produced.

The above files are required if locally-defined data elements are used in the archive product, and are recommended if the archive product does not use locally-defined data elements.

The PDSDD.FUL and PDSDD.IDX files can be labeled using either the TEXT or ASCII\_DOCUMENT objects.

Example: PDSDD.LBL

```

PDS_VERSION_ID      = PDS3
RECORD_TYPE        = STREAM

^FUL_TEXT           = "PDSDD.FUL"
^IDX_TEXT           = "PDSDD.IDX"

OBJECT              = FUL_TEXT
  PUBLICATION_DATE = 2003-12-31
END_OBJECT          = FUL_TEXT

OBJECT              = IDX_TEXT
  PUBLICATION_DATE = 2003-12-31
END_OBJECT          = IDX_TEXT
END

```

### 19.3.3.3 EXTRAS Subdirectory

The EXTRAS directory is the designated area for housing additional elements provided by data preparers beyond the scope of the PDS archive requirements. Examples include HTML-based disk navigators, educational and public interest aids, and other useful but nonessential items. The PDS places no restrictions on the contents and organization of this subdirectory other than conformance to ISO-9660/UDF standards.

#### **EXTRINFO.TXT**

**Required**

This file identifies and describes the function of each file in the EXTRAS subdirectory. This description should include at least the following:

1. A description of the structure and contents of each file in the subdirectory
2. Usage notes

### **19.3.3.4 GAZETTER Subdirectory**

This directory contains detailed information about all the named features on a target body (i.e., the gazetteer information) associated with the data sets on the volumes. “Named features” are those the International Astronomical Union (IAU) has named and approved. See Section A.15, GAZETTER\_TABLE, for more information.

#### **GAZINFO.TXT**

**Required**

This file identifies and describes the function of each file in the GAZETTER subdirectory.

**GAZETTER.TXT****Required**

This file contains text describing the structure and contents of the gazetteer table in GAZETTER.TAB.

**GAZETTER.LBL****Required**

This file is the PDS label containing a formal description of the structure of the gazetteer table.

**GAZETTER.TAB****Required**

This file contains the gazetteer table.

**19.3.3.5 GEOMETRY Subdirectory**

This directory contains the files (e.g., SEDR file, SPICE kernels, etc.) needed to describe the observation geometry for the data. Note that “GEOMETRY” is only a recommended directory name, another appropriate name may be used.

**GEOMINFO.TXT****Required**

This file identifies and describes the function of each file in the GEOMETRY subdirectory.

**19.3.3.6 LABEL Subdirectory**

This directory contains additional PDS labels and include files that were not packaged with the data products or in the data subdirectories. When multiple logical volumes reside on a single physical volume, the LABEL subdirectories *must* appear below the logical volume root directories. This is because the rules governing pointer resolution preclude a search across logical volumes.

**LABINFO.TXT****Required**

This file identifies and describes the function of each file in the LABEL subdirectory.

**Include Files****Required**

*Include* files are files referenced by a pointer in a PDS label. Typically they contain additional metadata or descriptive information. Only files of type LBL, TXT, or FMT (“format”) may be included in the LABEL subdirectory. In Figures 19.1-5, the files *axx*INCLUDE FILE1, *bxx*INCLUDE FILE1 and INCLUDE FILE1 represent sample files of the above types. The *axx* and *bxx* prefixes indicate that the include files for different data sets (*a* and *b*) may be combined in the same LABEL subdirectory.

Note that the *axx* and *bxx* prefixes in the sample names are neither required nor recommended. Data producers may use them to distinguish two or more files (by data set, instrument, or other



criteria). The data producer should replace the generic prefixes shown here by a suitable mnemonic.

### 19.3.3.7 SOFTWARE Subdirectory

This directory contains the software libraries, utilities, or application programs supplied for accessing or processing the data. It may also include descriptions of processing algorithms. Only public domain software may be included on PDS archive volumes.

Two subdirectory structures are available for organizing the SOFTWARE directory: platform-based and application-based. Platform-based is the recommended method for general archives and is described below. For an example of application-based organization see the example for SOFTINFO.TXT in *Appendix D* of this document, and the NAIF directory structure in *Appendix E*. See Section 11.3 for information about packaging software for inclusion in an archive product.

#### **SOFTINFO.TXT** **Required**

This file identifies and describes the function of each file in the SOFTWARE subdirectory.

#### **SRC Subdirectory** **Optional**

There can be a global SRC directory under the SOFTWARE directory if there is source code applicable to all platforms. For example, application-programming languages such as IDL are relatively platform independent and would be placed in a global SRC directory. Note that in the example below, there is both a global source directory as well as source directories at the lower levels.

#### **DOC Subdirectory** **Optional**

This directory contains documentation for the software in the parallel SRC directory.

#### **LIB Subdirectory** **Optional**

This directory contains libraries applicable to all platforms.

#### **Hardware Platform and Operating System/Environment Subdirectories** **Optional**

If only global source code is being provided on the volume, no further organization is required. If platform- or environment- specific software is being provided, the structure in Figure 19.6 should be followed. Specifically:

1. The hardware platform and the operating system/environment must be explicitly stated. If more than one operating system/environment (OS/Env) is supported for a single hardware platform, each should have its own subdirectory under the hardware directory. If there is only one, then that subdirectory can be promoted to the hardware directory level (via naming conventions). In Figure 19.6, several environments are supported for

platform HW1, but only one for HW2 – thus the difference in subdirectory structures.

2. The next directory level contains BIN, SRC, DOC, LIB and OBJ. If any of these are not applicable, it should be left out (i.e., empty directories should be omitted).
3. Following are examples of subdirectory names for both multiple and single OS/Env per platform. (This list is provided for illustration only. It is not meant to be exhaustive.)

Multiple	Single
<i>PC</i>	
DOS	PCDOS
WIN	PCWIN
WINNT	PCWINNT
OS2	PCOS2
<i>MAC</i>	
SYS7	MACSYS7
AUX	MACAUX
<i>SUN</i>	
SUNOS	SUNOS
SOLAR	SUNSOLAR
<i>VAX</i>	
VMS	VAXVMS
ULTRX	VAXULTRX
<i>SGI</i>	
IRX4	SGIIRX4
IRX5	SGIIRX5

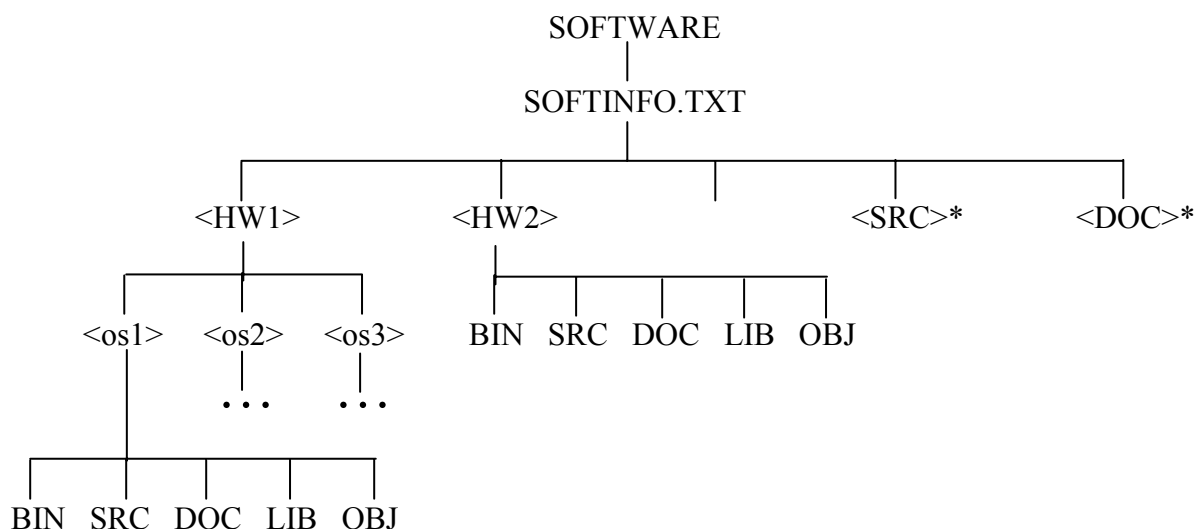

\* **NOTE:** INFO.TXT files under SOFTWARE subdirectories are optional (e.g., PCINFO.TXT, MACINFO.TXT, VAXINFO.TXT, SUNINFO.TXT, etc.).

**Figure 19.6 – Platform-based SOFTWARE Subdirectory Structure**

## 19.4 Volume Naming

Volume names must be no more than 60 characters in length and in upper case. They should describe the contents of the volume in terms that a human user can understand. In most cases the volume name is more specific than the volume set name. For example, the volume name for the first volume in the *VOYAGER IMAGES OF URANUS* volume set is “VOLUME 1: COMPRESSED IMAGES 24476.54 - 26439.58.”

### 19.4.1 Volume ID

Many types of media and the machines that read them place a limit on the length of the volume ID. Therefore, although the complete volume set ID should be placed on the outside label of the volume, a shorter version is actually used when the volume is recorded. PDS has adopted a limit of 11 characters for these terse volume identifiers. This volume ID consists of the last two components of the volume set ID, with the “X” wildcard values replaced by the sequence number associated with the particular volume (see the *Volume Set ID* Standard below). This ID must always be unique for PDS data volumes. The volume ID must be in upper case.

#### Examples:

VG_0002	Volume 2 of the Voyager set
MG_0001	The first volume of the Magellan set
VGRS_0001	A potential Voyager Radio Science collection

If a volume is redone because of errors in the initial production the volume ID should remain the same and the `VOLUME_VERSION_ID` incremented. This parameter is contained in the `VOLDESC.CAT` file on the volume. The version ID should also be placed on the external volume label as “Version *n*” where *n* indicates the revision number. A revision number greater than one indicates that the original volume should be replaced with the new version.

## 19.5 Volume Set Naming

The volume set name provides the full, formal name of a group of data volumes containing one or a collection of related data sets. Volume set names may be at most 60 characters in length and must be in upper case. Volume sets are normally considered a single orderable entity. For example, the volume series `MISSION TO VENUS` consists of the following volume sets:

```
MAGELLAN: THE MOSAIC IMAGE DATA RECORD
MAGELLAN: THE ALTIMETRY AND RADIOMETRY DATA RECORD
MAGELLAN: THE GLOBAL ALTIMETRY AND RADIOMETRY DATA RECORD
PRE-MAGELLAN RADAR AND GRAVITY DATA SET COLLECTION
```

In certain cases, the volume set name can be the same as the volume name, e.g., when the volume set consists of only one volume.

### 19.5.1 Volume Set ID

A *volume set* is a series of archive volumes that are closely related. In general, the volumes of a set will be distributed and used together. Each volume within the set must have a `VOLUME_ID` that is unique across the PDS archive. The volume set is identified by a `VOLUME_SET_ID` of up to 60 characters incorporating the range of constituent `VOLUME_ID`s. `VOLUME_SET_ID`s must be in upper case, and are composed by concatenating the following fields, separated by underscores, using abbreviations if necessary:

1. The country of origin (abbreviated)
2. The government branch
3. The discipline within the branch that is producing the volumes
4. A campaign, mission or spacecraft identifier followed by an optional instrument or product identifier (6 characters)
5. A 4-digit sequence identifier: The first digit(s) represent the volume set; the remaining digits contain “X”, representing the range of volumes in the set. Up to four “X” characters may be used.

#### Example

`USA_NASA_PDS_GO_10XX` could be the volume set ID for the Galileo EDR volume set, since there are less than 100 volumes (since the `XX` placeholder accommodates the range 01 - 99 only). Volume IDs for volumes in the set would then be `GO_1001`, `GO_1002`, etc.

**Note:** Because of the uniqueness constraint, data preparers should consult with their PDS data engineer when it comes time to formulate new VOLUME\_ID and VOLUME\_SET\_ID values.

### ***Volume Set IDs Prior to PDS Version 3.2***

Prior to version 3.2, the 4-digit sequence identifier (item 5 above) did not include the “X” wildcards. Instead, the last digits represented the volume. For example, on Magellan, a volume set ID “USA\_NASA\_JPL\_MG\_0001” was used *only* for the volume with the volume ID “MG\_0001”. Subsequent volumes in the same set had volume set IDs that differed in the final field. When a set of volumes was to be distributed as one logical unit, the volume set ID included the range of volume IDs.

### **Example**

USA\_NASA\_PDS\_VG\_0001\_TO\_VG\_0003 for the three volumes that comprise the Voyager Uranus volume set.

## **19.6 Logical Volume Naming**

Logical volumes retain the volume and volume set naming used at the physical volume level. For further information, see the “Volume Object” in *Appendix A* of this document.

## **19.7 Exceptions to This Standard**

In rare cases volume IDs are subject to restrictions imposed by specific hardware or software environments. Also, volumes made in the past may have IDs that do not meet this standard and there may be compelling reasons for keeping the same volume ID when making a new copy of the data. All new data sets, however, must adhere to this standard wherever possible.

<b>A</b>
----------

AAREADME.TXT	19-8
ancillary files	19-2
ancillary volume	19-2

<b>C</b>
----------

CALIB subdirectory	19-12
calibration files	19-12
calibration subdirectory	19-12
CALINFO.TXT	19-12
catalog object files	19-8
catalog objects	
how to supply	19-9
CATALOG subdirectory	19-8, 19-12
CATALOG.CAT	19-9
CATINFO.TXT	19-8
catalog pointer	19-9
CUMINDEX.LBL	19-11
CUMINDEX.TAB	19-11
cumulative index	19-11

<b>D</b>
----------

data dictionary files	19-13
PDSDD.FUL	19-13
PDSDD.IDX	19-13
see Planetary Science Data Dictionary	19-13
data files	
contents	19-10
DATA subdirectory	19-10

19-7	
DOCINFO.TXT	19-12
DOCUMENT subdirectory	19-12, 19-13

19-8

**19-8****19-10**

**19-12****19-12****19-12****19-13****19-14****19-14****19-15****19-15**

19-15

**19-16****19-16****E**

ERRATA.TXT	19-8
EXTRAS subdirectory	19-13
EXTRINFO.TXT	19-14

**G**

gazetteer table	19-15
GAZETTER subdirectory	19-14
GAZETTER.LBL	19-15
GAZETTER.TAB	19-15
GAZETTER.TXT	19-15
GAZINFO.TXT	19-14
GEOMETRY subdirectory	19-15
GEOMINFO.TXT	19-15

**I**

include files	19-15
INDEX subdirectory	19-10
INDEX.LBL	19-11
INDEX.TAB	19-11
INDEX_TABLE	19-11
INDXINFO.TXT	19-10

<b>L</b>
----------

label files	
contents	19-10
LABEL subdirectory	19-15
LABINFO.TXT	19-15
locally defined data elements	
data dictionary files	19-13
logical volumes	
multiple logical volumes (definition)	19-1
naming	19-20
single logical volume (definition)	19-1

<b>M</b>
----------

19-1

<b>P</b>
----------

physical media	
organization	19-1
Planetary Science Data Dictionary	
file labeling	19-13
locally defined data elements	19-13
PDSDD.FUL	19-13
PDSDD.IDX	19-13
pointers	
catalog	19-9

<b>R</b>
----------

<b>ROOT Directory Files</b>	<b>19-8</b>
-----------------------------	-------------

<b>S</b>
----------

SOFTINFO.TXT	19-16
SOFTWARE subdirectory	19-16

<b>T</b>
----------

target	
named features	19-14

<b>V</b>
----------

19-17



VOLDESC.CAT	19-8, 19-19
VOLDESC.SFD	19-8
VOLINFO.TXT	19-12, 19-13
volume	
ancillary volumes	19-2
definition	19-1
IDs	19-18
exceptions	19-20
logical volume naming	19-20
names	19-18
VOLUME	19-8
volume index	19-11
volume organization and naming	19-1
volume set	
definition	19-1
IDs	19-19
names	19-19
organization	
many data sets, many volumes	19-2, <b>19-7</b>
<i>many data sets, one physical volume</i>	<b>19-6</b>
many data sets, one volume	19-1
one data set, many volumes	19-1, 19-4
one data set, one volume	19-1, 19-3
recommendations	19-7
types	19-1
<i>volume set</i>	
<i>organization</i>	
<i>many data sets, one volume</i>	<b>19-5</b>
VOLUME_ID	19-19
VOLUME_SET_ID	19-19
VOLUME_VERSION_ID	19-19
	19-18
	19-18
	19-19
	19-19
	19-1
	19-1
volumes, logical	19-10

# Chapter 20. Zip Compression

The PDS standards support two different approaches to data compression:

1. In one case, a data object contains numbers that have been encoded using one of several supported methods (e.g., “Huffman first difference”). In this approach, the label describes the compressed data and the `ENCODING_TYPE` keyword indicates how the data object is to be decompressed by the user. PDS standards support this approach to compression for `IMAGE` objects only. For more information on compression of individual `IMAGE` objects, see Section A.19.
2. In the alternative approach, a standard compression method called “Zip” is used. In this case, an entire data file is compressed rather than a particular data object. The user is expected to apply an “Unzip” utility to decompress the file, and the label then describes the decompressed data directly.

This chapter describes PDS standards for archiving data using Zip compression. In general, the archiving of data in a compressed format should be used sparingly. Although compression reduces the number of physical volumes, it makes the data more difficult for users to interpret. PDS recommends that data compression be used only in limited situations, such as to compress very large and infrequently used data, or to archive processed data where the source product is readily available in a non-compressed PDS archive.

## 20.1 Zip Software

The Zip method was chosen because the algorithm and supporting software for all major platforms are available without charge to the general user community. The *Info-Zip Consortium* and Info-Zip working group, for example, provide information and software at these URLs:

**<http://www.info-zip.org/pub/infozip>**  
**<http://www.freesoftware.com/pub/infozip>**

This same information is available on line from PDS at:

**<http://pds.jpl.nasa.gov>**

## 20.2 Zip File Labels

When archiving data in Zip format, two files need to be considered: (1) the zip file itself, and (2) the data file produced by decompressing the zip file. PDS strongly recommends that these two files have the same name but different extensions: “.ZIP” for the zip file and a more descriptive extension (e.g., “.DAT” or “.IMG”) for the unzipped file. The “.ZIP” file extension is reserved exclusively for zip-compressed files within the PDS.

PDS does not recommend the practice of compressing multiple data files into a single zip file, unless those files reside in the same directory and have the same name, but different extensions. For example, if file “ABC.IMG” contains an image and file “ABC.TAB” contains a table of additional information relevant to that image, then both files can be archived in the file “ABC.ZIP”. This will minimize the potential confusion for a user who may not be able to locate a desired file because it is hidden inside a zip file with a different name.

Like all PDS data files, both the zipped and the unzipped data files require labels. Both files must be described by a single, detached PDS label file using the combined -detached label approach (see Section 5.2.2). Attached labels are not permitted for Zip-compressed data, because the user must be able to examine the label before deciding whether or not to decompress the file. In a combined -detached label, each individual file is described as a FILE object. Here is the general framework:

```

PDS_VERSION_ID      = PDS3
DATA_SET_ID        = ...
PRODUCT_ID         = ...
    (other parameters relevant to both Zipped and Unzipped files)

OBJECT              = COMPRESSED_FILE
    (parameters describing the compressed file)
END_OBJECT          = COMPRESSED_FILE

OBJECT              = UNCOMPRESSED_FILE
    (parameters describing the first uncompressed file)
END_OBJECT          = UNCOMPRESSED_FILE

OBJECT              = UNCOMPRESSED_FILE
    (parameters describing a second uncompressed file, if present)
END_OBJECT          = UNCOMPRESSED_FILE
END

```

The first FILE object, the COMPRESSED\_FILE, refers to the zipped file; additional FILE objects, called UNCOMPRESSED\_FILES, refer to the decompressed data file(s) that the user will obtain by unzipping the first.

The zip file is described via a “minimal label ” (see Section 5.2.3). The following keywords are required:

```

FILE_NAME           = name of the zipfile
RECORD_TYPE        = UNDEFINED
ENCODING_TYPE      = ZIP
INTERCHANGE_FORMAT = BINARY
UNCOMPRESSED_FILE_NAME = a list of the names of all the files archived
                        in the zipfile
REQUIRED_STORAGE_BYTES = approximate total number of bytes in the data
                        files
DESCRIPTION         = a brief description of the zipfile format

```

Typically, the DESCRIPTION is given as a pointer to a file called “ZIPINFO.TXT ” found in the DOCUMENT directory on the same volume.

The subsequent UNCOMPRESSED\_FILE object(s) contain complete descriptions of the data files obtained by unzipping the zip file.

### **20.3 Packaging Zip Archives on Volumes**

A volume containing zip files with combined-detached labels as presented above conforms to all established PDS standards *provided both the zip file and its constituent data files are archived.*

The unique feature of a Zip-compressed PDS archive volume is that only the zip files appear; the UNCOMPRESSED\_FILE objects described by the labels are not present on the volume, but can be obtained by unzipping the zip files provided.

In the interests of long-term archiving, a PDS archive zip file must include all the support files required to completely reconstitute the labeled data files. Specifically, the zipped archive must include not only the data files, but also the label file(s) for the uncompressed data. Ideally, any .FMT files referenced by ^STRUCTURE keywords in the labels should also be included in the

```

RECORD_BYTES          = 2880
FILE_RECORDS          = 12
^FITS_HEADER          = ("0101_SHF.DAT",      1 <BYTES>)
^HEADER_TABLE         = ("0101_SHF.DAT", 25921 <BYTES>)

OBJECT                = FITS_HEADER
  HEADER_TYPE         = FITS
  INTERCHANGE_FORMAT = ASCII
  RECORDS             = 7
  BYTES               = 20160
  ^DESCRIPTION        = "FITS.TXT"
END_OBJECT            = FITS_HEADER

OBJECT                = HEADER_TABLE
  NAME                = HEADER_PACKET
  INTERCHANGE_FORMAT = BINARY
  ROWS                 = 965
  COLUMNS             = 1

  ROW_BYTES           = 2
  DESCRIPTION         = "This is the HST standard header packet
                        containing observation parameters. It is
                        stored as a sequence of 965 two-byte
                        integers. For more detailed information,
                        contact Space Telescope Science Institute."

OBJECT                = COLUMN
  NAME                 = PACKET_VALUES
  DATA_TYPE           = MSB_INTEGER
  START_BYTE           = 1
  BYTES                 = 2
END_OBJECT            = COLUMN
END_OBJECT            = HEADER_TABLE

END_OBJECT            = UNCOMPRESSED_FILE
END

```

## 20.5 ZIPINFO.TXT Example

While the ZIPINFO.TXT file is not required, it is strongly recommended that this file be included as part of the process of documenting the contents of a zip file. The following is an example ZIPINFO.TXT file and the type of information that should be included in the ZIPINFO.TXT file:

```

PDS_VERSION_ID       = PDS3
RECORD_TYPE          = STREAM

OBJECT                = TEXT
  PUBLICATION_DATE    = 1999-07-26
  NOTE                 = "This file provides an overview of the ZIP
                        file format."

END_OBJECT            = TEXT

```

END

Many of the files in this data set are compressed using Zip format. They are all indicated by the extension ".ZIP". ZIP is a utility that compresses files and also allows for multiple files to be stored in a single Zip archive. You will need the UNZIP utility to extract the files.

The SOFTWARE directory on this volume contains a complete description of the Zip file format and also the complete source code for the UNZIP utility. The file format and file decompression algorithms are described in the file SOFTWARE/APPNOTE.TXT.

It is far simpler to obtain a pre-built binary of the UNZIP application for your platform. Binaries for most platforms are available from the Info-ZIP web site, currently at these URLs:

```
http://www.info-zip.org/pub/infozip  
http://www.freesoftware.com/pub/infozip
```

The same information can also be found at the PDS Central Node's web site, currently at:

```
http://pds.jpl.nasa.gov/
```

## 20.6 Additional Files

As of this writing, Zip appears to be a robust standard with a long future of general use. Nevertheless, PDS long-term archiving goals reach well past the lifetime of many popular standards, past and present. For this reason, a ny volume containing zip files is required to contain a complete description of the zip file format with sample "Unzip" source code. This information must be located in an appropriate subdirectory of the SOFTWARE directory tree. The required text and source code may be obtained directly from the Info-Zip web site or by contacting a Central Node data engineer.

- COMPRESSED\_FILE, 20-2
- data compression, 20-1
  - Zip, 20-1
    - example, 20-3
    - file format, 20-1
    - on archive volumes, 20-3
- DOCUMENT subdirectory, 20-2
- ENCODING\_TYPE, 20-1
- FILE object, 20-2
- IMAGE objects
  - compression, 20-1
- minimal labels
  - and compressed data, 20-2
- REQUIRED\_STORAGE\_BYTES, 20-3
- UNCOMPRESSED\_FILE, 20-2
- UNCOMPRESSED\_FILE\_NAME, 20-3
- Zip compression, 20-1
- ZIPINFO.TXT, 20-2, 20-4

# Appendix A. PDS Data Object Definitions

This section provides an alphabetical reference of approved PDS data object definitions used for labeling primary and secondary data objects. The definitions include descriptions, lists of required and optional keywords, lists of required and optional subobjects (or child objects), and one or more examples of specific objects. For a more detailed discussion on primary and secondary data objects, see the *Data Products* chapter in this document.

Data object definitions are refined and augmented from time to time, as user community needs arise, so object definitions for products designed under older versions of the Standards may differ significantly. To check the current state of any object definition, consult a PDS data engineer or either of these URLs:

PDS Catalog Search: <http://pdsproto.jpl.nasa.gov/onlinecatalog/top.cfm>

Data Dictionary Search: <http://pdsproto.jpl.nasa.gov/ddcolstdval/newdd/top.cfm>

The examples provided in this Appendix are based on both existing and planned PDS archive products, modified to reflect the current version of the PDS Standards. Additional examples may be obtained by contacting a PDS Data Engineer.

NOTE: Any keywords in the *Planetary Science Data Dictionary* may also be included in a specific data object definition.

## *Primitive Objects*

There exist four primitive data objects: ARRAY; BIT\_ELEMENT; COLLECTION; and ELEMENT. Although these objects are available, they should only be used after careful consideration of the current high-level PDS Data Objects. Please see the *PDS Objects* chapter in this document for guidelines on the use of primitive objects.



## Chapter Contents

Appendix A.	PDS Data Object Definitions.....	A-1
A.1	ALIAS.....	A-3
A.2	ARRAY (Primitive Data Object).....	A-4
A.3	BIT_COLUMN.....	A-8
A.4	BIT ELEMENT (Primitive Data Object).....	A-11
A.5	CATALOG.....	A-12
A.6	COLLECTION (Primitive Data Object).....	A-15
A.7	COLUMN.....	A-16
A.8	CONTAINER.....	A-20
A.9	DATA_PRODUCER.....	A-27
A.10	DATA_SUPPLIER.....	A-29
A.11	DIRECTORY.....	A-31
A.12	DOCUMENT.....	A-33
A.13	ELEMENT (Primitive Data Object).....	A-36
A.14	FIELD.....	A-38
A.15	FILE.....	A-41
A.16	GAZETTEER_TABLE.....	A-45
A.17	HEADER.....	A-55
A.18	HISTOGRAM.....	A-57
A.19	HISTORY.....	A-60
A.20	IMAGE.....	A-64
A.21	INDEX_TABLE.....	A-69
A.22	PALETTE.....	A-74
A.23	QUBE.....	A-77
A.24	SERIES.....	A-85
A.25	SPECTRUM.....	A-90
A.26	SPICE KERNEL.....	A-93
A.27	SHREADSHEET.....	A-96
A.28	TABLE.....	A-101
A.29	TEXT.....	A-122
A.30	VOLUME.....	A-124

## A.1 ALIAS

The ALIAS object provides a method for identifying alternate terms or names for approved data elements or objects within a data system. The ALIAS object is an optional sub-object of the COLUMN object.

### A.1.1 Required Keywords

1. ALIAS\_NAME
2. USAGE\_NOTE

### A.1.2 Optional Keywords

Any

### A.1.3 Required Objects

None

### A.1.4 Optional Objects

None

### A.1.5 Example

The following label fragment shows the ALIAS object included as a sub-object of a COLUMN:

```

OBJECT          = COLUMN
  NAME          = ALT_FOOTPRINT_LONGITUDE
  START_BYTE   = 1
  DATA_TYPE   = REAL
  BYTES        = 10

  OBJECT        = ALIAS
    ALIAS_NAME  = AR_LON
    USAGE_NOTE  = "MAGELLAN MIT ARCDR SIS"
  END_OBJECT   = ALIAS
END_OBJECT     = COLUMN

```

## A.2 ARRAY (Primitive Data Object)

The ARRAY object is provided to describe dimensioned arrays of homogeneous objects. Note that an ARRAY may contain only a single sub-object, which can itself be another ARRAY or COLLECTION if required. A maximum of 6 axes is allowed in an ARRAY. By default, the rightmost axis is the fastest varying axis.

The optional “AXIS\_\*” elements are used to describe the variation between successive objects in the ARRAY. Values for AXIS\_ITEMS and “AXIS\_\*” elements for multidimensional arrays are listed in axis order. The optional START\_BYTE data element provides the starting location relative to an enclosing object. If a START\_BYTE is not specified, a value of 1 is assumed.

### A.2.1 Required Keywords

1. AXES
2. AXIS\_ITEMS
3. NAME

### A.2.2 Optional Keywords

1. AXIS\_INTERVAL
2. AXIS\_NAME
3. AXIS\_UNIT
4. AXIS\_START
5. AXIS\_STOP
6. AXIS\_ORDER\_TYPE
7. CHECKSUM
8. DESCRIPTION
9. INTERCHANGE\_FORMAT
10. START\_BYTE

### A.2.3 Required Objects

None

Note that while no specific sub-object is required, the ARRAY object must contain at least one of the optional objects, following. That is, a null ARRAY object may not be defined.

## A.2.4 Optional Objects

1. ARRAY
2. BIT\_ELEMENT
3. COLLECTION
4. ELEMENT

## A.2.5 Example 1

Following is an example of a two-dimensional spectrum array in a detached label.

```

PDS_VERSION_ID          = PDS3
RECORD_TYPE             = FIXED_LENGTH
RECORD_BYTES           = 1600
FILE_RECORDS           = 180

DATA_SET_ID             = "IHW-C-SPEC-2-EDR-HALLEY-V1.0"
OBSERVATION_ID         = "704283"
TARGET_NAME            = "HALLEY"
INSTRUMENT_HOST_NAME   = "IHW SPECTROSCOPY AND SPECTROPHOTOMETRY
                        NETWORK"
INSTRUMENT_NAME        = "IHW SPECTROSCOPY AND SPECTROPHOTOMETRY"
PRODUCT_ID             = "704283"
OBSERVATION_TIME       = 1986-05-09T04:10:20.640
START_TIME             = 1986-05-09T04:07:50.640
STOP_TIME              = UNK
PRODUCT_CREATION_TIME  = 1993-01-01T00:00:00.000
^ARRAY                 = "SPEC2702.DAT"

/* Description of Object in File */

OBJECT                  = ARRAY
  NAME                  = "2D SPECTRUM"
  INTERCHANGE_FORMAT   = BINARY
  AXES                  = 2
  AXIS_ITEMS           = (180,800)
  AXIS_NAME            = ("RHO","APPROXIMATE WAVELENGTH")
  AXIS_UNIT            = (ARCSEC,ANGSTROMS)
  AXIS_INTERVAL        = (1.5,7.2164)
  AXIS_START           = (1.0,5034.9)

OBJECT                  = ELEMENT
  DATA_TYPE           = MSB_INTEGER
  BYTES               = 2
  NAME                = COUNT
  DERIVED_MAXIMUM     = 2.424980E+04
  DERIVED_MINIMUM     = 0.000000E+00
  OFFSET              = 0.000000E+00

```

```

SCALING_FACTOR      = 1.000000E+00
NOTE                = "Conversion factor 1.45 may be applied
                    to data to estimate photons/sq
                    m/sec/angstrom at 6800 angstroms."

END_OBJECT          = ELEMENT
END_OBJECT          = ARRAY
END

```

## A.2.6 Example 2

The following label shows ARRAY, COLLECTION and ELEMENT primitive objects all used together.

```

PDS_VERSION_ID      = PDS3
RECORD_TYPE         = FIXED_LENGTH
RECORD_BYTES        = 122
FILE_RECORDS        = 7387

^ARRAY              = "MISCHA01.DAT"

DATA_SET_ID         = "VEGA1-C-MISCHA-3-RDR-HALLEY-V1.0"
TARGET_NAME         = HALLEY
SPACECRAFT_NAME     = "VEGA 1"
INSTRUMENT_NAME     = "MAGNETOMETER"
PRODUCT_ID          = "XYZ"
START_TIME          = "UNK"
STOP_TIME           = "UNK"
SPACECRAFT_CLOCK_START_COUNT = "UNK"
SPACECRAFT_CLOCK_STOP_COUNT  = "UNK"

NOTE                = "VEGA 1 MISCHA DATA"

OBJECT              = ARRAY
  NAME               = MISCHA_DATA_FILE
  INTERCHANGE_FORMAT = BINARY
  AXES               = 1
  AXIS_ITEMS         = 7387
  DESCRIPTION        = "This file contains an array of fixed-
                    length Mischa records."

OBJECT              = COLLECTION
  NAME               = MISCHA_RECORD
  BYTES              = 122
  DESCRIPTION        = "Each record in this file consists of a
                    time tag followed by a 20-element array
                    of magnetic field vectors."

OBJECT              = ELEMENT
  NAME               = START_TIME
  BYTES              = 2
  DATA_TYPE         = MSB_INTEGER
  START_BYTE         = 1

```

```

END_OBJECT          = ELEMENT

OBJECT              = ARRAY
  NAME              = MAGNETIC_FIELD_ARRAY
  AXES              = 2
  AXIS_ITEMS        = (3,20)
  START_BYTE        = 3
  AXIS_NAME         = ("XYZ_COMPONENT","TIME" )
  AXIS_UNIT         = ("N/A"           ,"SECOND")
  AXIS_INTERVAL     = ("N/A"           , 0.2   )
  DESCRIPTION       = "Magnetic field vectors were recorded at
                       the rate of 10 per second. The
                       START_TIME field gives the time at
                       which the first vector in the record
                       was recorded. Successive vectors were
                       recorded at 0.2 second intervals."

OBJECT              = ELEMENT
  NAME              = MAG_FIELD_COMPONENT_VALUE
  BYTES             = 2
  DATA_TYPE        = MSB_INTEGER
  START_BYTE        = 1
  END_OBJECT        = ELEMENT
END_OBJECT          = ARRAY

END_OBJECT          = COLLECTION

END_OBJECT          = ARRAY
END

```

## A.3 BIT\_COLUMN

The BIT\_COLUMN object identifies a string of bits that do not fall on even byte boundaries and therefore cannot be described as a distinct COLUMN. BIT\_COLUMNS defined within columns are analogous to columns defined within rows.

Notes:

- (1) The Planetary Data System recommends that all fields (within new objects) be defined on byte boundaries. This precludes having multiple values strung together in bit strings, as occurs in the BIT\_COLUMN object.
- (2) BIT\_COLUMN is intended for use in describing existing binary data strings, but is not recommended for use in defining new data objects because it will not be recognized by most general purpose software.
- (3) A BIT\_COLUMN must not contain embedded objects.

BIT\_COLUMNS of the same format and size may be specified as a single BIT\_COLUMN by using the ITEMS, ITEM\_BITS, and ITEM\_OFFSET elements. The ITEMS data element is used to indicate the number of occurrences of a bit string.

### A.3.1 Required Keywords

1. NAME
2. BIT\_DATA\_TYPE
3. START\_BIT
4. BITS (required for BIT\_COLUMNS without items)
5. DESCRIPTION

### A.3.2 Optional Keywords

1. BIT\_MASK
2. BITS (optional for BIT\_COLUMNSs with ITEMS)
3. FORMAT
4. INVALID\_CONSTANT
5. ITEMS
6. ITEM\_BITS
7. ITEM\_OFFSET
8. MINIMUM
9. MAXIMUM
10. MISSING\_CONSTANT
11. OFFSET

## 12. SCALING\_FACTOR

## 13. UNIT

**A.3.3 Required Objects**

None

**A.3.4 Optional Objects**

None

**A.3.5 Example**

The label fragment below was extracted from a larger example which can be found under the CONTAINER object. The BIT\_COLUMN object can be a sub-object only of a COLUMN object, but that COLUMN may itself be part of a TABLE, SPECTRUM, SERIES or CONTAINER object.

---

```

OBJECT          = COLUMN
  NAME          = PACKET_ID
  DATA_TYPE    = LSB_BIT_STRING
  START_BYTE    = 1
  BYTES         = 2
  VALID_MINIMUM = 0
  VALID_MAXIMUM = 7
  DESCRIPTION   = "Packet_id constitutes one of three
                  parts in the primary source information
                  header applied by the Payload Data
                  System (PDS) to the MOLA telemetry
                  packet at the time of creation of the
                  packet prior to transfer frame
                  creation."

OBJECT          = BIT_COLUMN
  NAME          = VERSION_NUMBER
  BIT_DATA_TYPE = MSB_UNSIGNED_INTEGER
  START_BIT     = 1
  BITS          = 3
  MINIMUM       = 0
  MAXIMUM       = 7
  DESCRIPTION   = "These bits identify Version 1 as the
                  Source Packet structure.  These bits
                  shall be set to '000'."

END_OBJECT     = BIT_COLUMN

OBJECT          = BIT_COLUMN

```



```

NAME = SPARE
BIT_DATA_TYPE = MSB_UNSIGNED_INTEGER
START_BIT = 4
BITS = 1
MINIMUM = 0
MAXIMUM = 0
DESCRIPTION = "Reserved spare. This bit shall be set
to '0'"
END_OBJECT = BIT_COLUMN

OBJECT = BIT_COLUMN
NAME = FLAG
BIT_DATA_TYPE = BOOLEAN
START_BIT = 5
BITS = 1
MINIMUM = 0
MAXIMUM = 0
DESCRIPTION = "This flag signals the presence or
absence of a Secondary Header data
structure within the Source Packet.
This bit shall be set to '0' since no
Secondary Header formatting standards
currently exist for Mars Observer."
END_OBJECT = BIT_COLUMN

OBJECT = BIT_COLUMN
NAME = ERROR_STATUS
BIT_DATA_TYPE = MSB_UNSIGNED_INTEGER
START_BIT = 6
BITS = 3
MINIMUM = 0
MAXIMUM = 7
DESCRIPTION = "This field identifies in part the
individual application process within
the spacecraft that created the Source
Packet data."
END_OBJECT = BIT_COLUMN

OBJECT = BIT_COLUMN
NAME = INSTRUMENT_ID
BIT_DATA_TYPE = MSB_UNSIGNED_INTEGER
START_BIT = 9
BITS = 8
MINIMUM = "N/A"
MAXIMUM = "N/A"
DESCRIPTION = "This field identifies in part the
individual application process within
the spacecraft that created the Source
Packet data. 00100011 is the bit
pattern for MOLA."
END_OBJECT = BIT_COLUMN
END_OBJECT = COLUMN

```

## **A.4 BIT ELEMENT (Primitive Data Object)**

Under review.

## A.5 CATALOG

The CATALOG object is used within a VOLUME object to reference the completed PDS high-level catalog object set. The catalog object set provides additional information related to the data sets on a volume. Please refer to the *File Specification and Naming* chapter in this document for more information.

### A.5.1 Required Keywords

None

### A.5.2 Optional Keywords

1. DATA\_SET\_ID
2. LOGICAL\_VOLUME\_PATHNAME
3. LOGICAL\_VOLUMES

### A.5.3 Required Objects

1. DATA\_SET
2. INSTRUMENT
3. INSTRUMENT\_HOST
4. MISSION

### A.5.4 Optional Objects

1. DATA\_SET\_COLLECTION
2. PERSONNEL
3. REFERENCE
4. TARGET

### A.5.5 Example

The example below is a VOLDESC.CAT file for a volume containing multiple data sets. In this case, the catalog objects are provided in separate files referenced by pointers.

```

PDS_VERSION_ID           = PDS3
LABEL_REVISION_NOTE     ="1998-07-01, S. Joy (PPI);"
RECORD_TYPE              = STREAM

```

OBJECT	= VOLUME
VOLUME_SERIES_NAME	= "VOYAGERS TO THE OUTER PLANETS"
VOLUME_SET_NAME	= "VOYAGER NEPTUNE PLANETARY PLASMA INTERACTIONS DATA"
VOLUME_SET_ID	= USA_NASA_PDS_VG_1001
VOLUMES	= 1
VOLUME_NAME	= "VOYAGER NEPTUNE PLANETARY PLASMA INTERACTIONS DATA"
VOLUME_ID	= VG_1001
VOLUME_VERSION_ID	= "VERSION 1"
VOLUME_FORMAT	= "ISO-9660"
MEDIUM_TYPE	= "CD-ROM"
PUBLICATION_DATE	= 1992-11-13
DESCRIPTION	= "This volume contains a collection of non-imaging Planetary Plasma datasets from the Voyager 2 spacecraft encounter with Neptune. Included are datasets from the Cosmic Ray System (CRS), Plasma System (PLS), Plasma Wave System (PWS), Planetary Radio Astronomy (PRA), Magnetometer (MAG), and Low Energy Charged Particle (LECP) instruments, as well as spacecraft position vectors (POS) in several coordinate systems. The volume also contains documentation and index files to support access and use of the data."
DATA_SET_ID	= {"VG2-N-CRS-3-RDR-D1-6SEC-V1.0", "VG2-N-CRS-4-SUMM-D1-96SEC-V1.0", "VG2-N-CRS-4-SUMM-D2-96SEC-V1.0", "VG2-N-LECP-4-SUMM-SCAN-24SEC-V1.0", "VG2-N-LECP-4-RDR-STEP-12.8MIN-V1.0", "VG2-N-MAG-4-RDR-HG-COORDS-1.92SEC-V1.0", "VG2-N-MAG-4-SUMM-HG-COORDS-48SEC-V1.0", "VG2-N-MAG-4-RDR-HG-COORDS-9.6SEC-V1.0", "VG2-N-MAG-4-SUMM-NLSCOORDS-12SEC-V1.0", "VG2-N-PLS-5-RDR-2PROMAGSPH-48SEC-V1.0", "VG2-N-PLS-5-RDR-ELEMAGSPHERE-96SEC-V1.0", "VG2-N-PLS-5-RDR-IONMAGSPHERE-48SEC-V1.0", "VG2-N-PLS-5-RDR-IONLMODE-48SEC-V1.0", "VG2-N-PLS-5-RDR-IONMMODE-12MIN-V1.0", "VG2-N-PLS-5-RDR-ION-INBNDWIND-48SEC-V1.0", "VG2-N-POS-5-RDR-HGHGCOORDS-48SEC-V1.0", "VG2-N-POS-5-SUMM-NLSCOORDS-12-48SEC-V1.0", "VG2-N-PRA-4-SUMM-BROWSE-SEC-V1.0", "VG2-N-PRA-2-RDR-HIGHRATE-60MS-V1.0", "VG2-N-PWS-2-RDR-SA-4SEC-V1.0", "VG2-N-PWS-4-SUMM-SA-48SEC-V1.0", "VG2-N-PWS-1-EDR-WFRM-60MS-V1.0"}
OBJECT	= DATA_PRODUCER
INSTITUTION_NAME	= "UNIVERSITY OF CALIFORNIA, LOS ANGELES"
FACILITY_NAME	= "PDS PLANETARY PLASMA INTERACTIONS NODE"

```

FULL_NAME           = "DR. RAYMOND WALKER"
DISCIPLINE_NAME     = "PLASMA INTERACTIONS"
ADDRESS_TEXT        = "UCLA
                      IGPP
                      LOS ANGELES, CA 90024 USA"
END_OBJECT          = DATA_PRODUCER

OBJECT              = DATA_SUPPLIER
INSTITUTION_NAME    = "NATIONAL SPACE SCIENCE DATA CENTER"
FACILITY_NAME       = "NATIONAL SPACE SCIENCE DATA CENTER"
FULL_NAME           = "NATIONAL SPACE SCIENCE DATA CENTER"
DISCIPLINE_NAME     = "NATIONAL SPACE SCIENCE DATA CENTER"
ADDRESS_TEXT        = "Code 633 \n
                      Goddard Space Flight Center \n
                      Greenbelt, Maryland, 20771, USA"
TELEPHONE_NUMBER    = "3012866695"
ELECTRONIC_MAIL_TYPE = "NSI/DECNET"
ELECTRONIC_MAIL_ID  = "NSSDCA::REQUEST"
END_OBJECT          = DATA_SUPPLIER

OBJECT              = CATALOG
^MISSION_CATALOG    = "MISSION.CAT"
^INSTRUMENT_HOST_CATALOG = "INSTHOST.CAT"
^INSTRUMENT_CATALOG = {"CRS_INST.CAT",
                      "LECPINST.CAT",
                      "MAG_INST.CAT",
                      "PLS_INST.CAT",
                      "PRA_INST.CAT",
                      "PWS_INST.CAT"}
^DATA_SET_CATALOG   = {"CRS_DS.CAT",
                      "LECP_DS.CAT",
                      "MAG_DS.CAT",
                      "PLS_DS.CAT",
                      "POS_DS.CAT",
                      "PRA_DS.CAT",
                      "PWS_DS.CAT"}
^TARGET_CATALOG     = TARGET.CAT
^PERSONNEL_CATALOG  = PERSON.CAT
^REFERENCE_CATALOG  = REF.CAT
END_OBJECT          = CATALOG

END_OBJECT          = VOLUME
END

```

## A.6 COLLECTION (Primitive Data Object)

The COLLECTION object allows the ordered grouping of heterogeneous objects into a structure. The COLLECTION object may contain a mixture of different object types, including other COLLECTIONs. The optional START\_BYTE data element provides the starting location relative to an enclosing object. If a START\_BYTE is not specified, a value of 1 is assumed.

### A.6.1 Required Keywords

1. BYTES
2. NAME

### A.6.2 Optional Keywords

1. DESCRIPTION
2. CHECKSUM
3. INTERCHANGE\_FORMAT
4. START\_BYTE

### A.6.3 Required Objects

None

Note that although a specific sub-object is not required, the COLLECTION must contain at least one of the optional objects listed following. That is, a null COLLECTION may not be defined.

### A.6.4 Optional Objects

1. ELEMENT
2. BIT\_ELEMENT
3. ARRAY
4. COLLECTION

### A.6.5 Example

Please refer to Section A.2.6, *Example 2* under the ARRAY object for an illustration of the COLLECTION object used in conjunction with other primitive objects.

## A.7 COLUMN

The COLUMN object identifies a single column in a data object.

Notes:

- (1) Current PDS data objects that include COLUMN objects are the TABLE, CONTAINER, SPECTRUM and SERIES objects.
- (2) COLUMNS must not themselves contain embedded COLUMN objects.
- (3) COLUMNS of the same format and size which constitute a vector may be specified as a single COLUMN by using the ITEMS, ITEM\_BYTES, and ITEM\_OFFSET elements. The ITEMS data element indicates the number of occurrences of the field (i.e., elements in the vector).
- (4) BYTES and ITEM\_BYTES counts do not include leading or trailing delimiters or line terminators.
- (5) For a COLUMN containing ITEMS, the value of BYTES should represent the total size of the column including delimiters between the items. (See examples 1 and 2 below.)

### A.7.1 Required Keywords

1. NAME
2. DATA\_TYPE
3. START\_BYTE
4. BYTES (required for COLUMNS without ITEMS)

### A.7.2 Optional Keywords

1. BIT\_MASK
2. BYTES (optional for COLUMNS with ITEMS)
3. COLUMN\_NUMBER
4. DERIVED\_MAXIMUM
5. DERIVED\_MINIMUM
6. DESCRIPTION
7. FORMAT
8. INVALID\_CONSTANT
9. ITEM\_BYTES
10. ITEM\_OFFSET
11. ITEMS
12. MAXIMUM
13. MAXIMUM\_SAMPLING\_PARAMETER
14. MINIMUM
15. MINIMUM\_SAMPLING\_PARAMETER

- 16. MISSING\_CONSTANT
- 17. OFFSET
- 18. SAMPLING\_PARAMETER\_INTERVAL
- 19. SAMPLING\_PARAMETER\_NAME
- 20. SAMPLING\_PARAMETER\_UNIT
- 21. SCALING\_FACTOR
- 22. UNIT
- 23. VALID\_MAXIMUM
- 24. VALID\_MINIMUM

### A.7.3 Required Objects

None

### A.7.4 Optional Objects

- 1. BIT\_COLUMN
- 2. ALIAS

### A.7.5 Example 1

The label fragment below shows a simple COLUMN object, in this case from an ASCII TABLE.

```

OBJECT          = COLUMN
  NAME          = "DETECTOR TEMPERATURE"
  START_BYTE   = 27
  BYTES        = 5
  DATA_TYPE   = ASCII_REAL
  FORMAT       = "F5.1"
  UNIT         = "KELVIN"
  MISSING_CONSTANT = 999.9
END_OBJECT     = COLUMN

```

### A.7.6 Example 2

The fragment below shows two COLUMNS containing multiple items. The first COLUMN is a vector containing three ASCII\_INTEGER items: xx, yy, zz. The second COLUMN contains three character items: "xx", "yy" and "zz". Note that the value of BYTES includes the comma delimiters between items, but the ITEM\_BYTES value does not. The ITEM\_OFFSET is the number of bytes from the beginning of one item to the beginning of the next.

```

OBJECT          = COLUMN
  NAME          = COLUMN1XYZ
  DATA_TYPE   = ASCII_INTEGER

```



```

START_BYTE           = 1
BYTES                = 8 /*includes delimiters*/
ITEMS                = 3
ITEM_BYTES           = 2
ITEM_OFFSET          = 3
END_OBJECT           = COLUMN

OBJECT               = COLUMN
  NAME                = COLUMN2XYZ
  DATA_TYPE          = CHARACTER
  START_BYTE          = 2 /* value does not include leading quote */
  BYTES                = 12 /* value does not include leading and */
                       /* trailing quotes */
  ITEMS                = 3
  ITEM_BYTES           = 2 /* value does not include leading and */
                       /* trailing quotes */
  ITEM_OFFSET          = 5 /* value does not include leading quote */
END_OBJECT           = COLUMN

```

### A.7.7 Example 3

The fragment below was extracted from a larger example which can be found under the CONTAINER object. It illustrates a single COLUMN object subdivided into several BIT\_COLUMN fields.

```

OBJECT               = COLUMN
  NAME                = PACKET_ID
  DATA_TYPE          = LSB_BIT_STRING
  START_BYTE          = 1
  BYTES                = 2
  VALID_MINIMUM       = 0
  VALID_MAXIMUM       = 7
  DESCRIPTION         = "Packet_id constitutes one of three
                        parts in the primary source
                        information header applied by the
                        Payload Data System (PDS) to the MOLA
                        telemetry packet at the time of
                        creation of the packet prior to
                        transfer frame creation. "

OBJECT               = BIT_COLUMN
  NAME                = VERSION_NUMBER
  BIT_DATA_TYPE       = MSB_UNSIGNED_INTEGER
  START_BIT           = 1
  BITS                = 3
  MINIMUM              = 0
  MAXIMUM              = 7
  DESCRIPTION         = "These bits identify Version 1 as the
                        Source Packet structure. These bits
                        shall be set to '000'."

END_OBJECT           = BIT_COLUMN

OBJECT               = BIT_COLUMN

```

```

NAME = SPARE
BIT_DATA_TYPE = MSB_UNSIGNED_INTEGER
START_BIT = 4
BITS = 1
MINIMUM = 0
MAXIMUM = 0
DESCRIPTION = "Reserved spare. This bit shall be set
to '0'"
END_OBJECT = BIT_COLUMN

OBJECT = BIT_COLUMN
NAME = FLAG
BIT_DATA_TYPE = BOOLEAN
START_BIT = 5
BITS = 1
MINIMUM = 0
MAXIMUM = 0
DESCRIPTION = "This flag signals the presence or
absence of a Secondary Header data
structure within the Source Packet.
This bit shall be set to '0' since no
Secondary Header formatting standards
currently exist for Mars Observer."
END_OBJECT = BIT_COLUMN

OBJECT = BIT_COLUMN
NAME = ERROR_STATUS
BIT_DATA_TYPE = MSB_UNSIGNED_INTEGER
START_BIT = 6
BITS = 3
MINIMUM = 0
MAXIMUM = 7
DESCRIPTION = "This field identifies in part the
individual application process within
the spacecraft that created the Source
Packet data."
END_OBJECT = BIT_COLUMN

OBJECT = BIT_COLUMN
NAME = INSTRUMENT_ID
BIT_DATA_TYPE = MSB_UNSIGNED_INTEGER
START_BIT = 9
BITS = 8
MINIMUM = "N/A"
MAXIMUM = "N/A"
DESCRIPTION = "This field identifies in part the
individual application process within
the spacecraft that created the Source
Packet data. 00100011 is the bit
pattern for MOLA."
END_OBJECT = BIT_COLUMN
END_OBJECT = COLUMN

```

## A.8 CONTAINER

The CONTAINER object is used to group a set of sub-objects (such as COLUMNS) that repeat within a data object (such as a TABLE). Use of the CONTAINER object allows repeating groups to be defined within a data structure.

### A.8.1 Required Keywords

1. NAME
2. START\_BYTE
3. BYTES
4. REPETITIONS
5. DESCRIPTION

### A.8.2 Optional Keywords

Any

### A.8.3 Required Objects

None

### A.8.4 Optional Objects

1. COLUMN
2. CONTAINER

### A.8.5 Example

The set of labels and format fragments below illustrates a data product layout in which the CONTAINER object is used. The primary data product is a TABLE of data records. Each record within the TABLE begins with 48 columns (143 bytes) of engineering data. The data product acquires science data from seven different frames. Since the data from each frame are formatted identically, one CONTAINER description suffices for all seven frames.

In this example there are two CONTAINER objects. The first CONTAINER object describes the repeating frame information. Within this CONTAINER there is a second CONTAINER object in which a 4-byte set of three COLUMN objects repeats 20 times. The use of the second CONTAINER object permits the data supplier to describe the three COLUMNS (4 bytes) once, instead of specifying sixty column definitions.

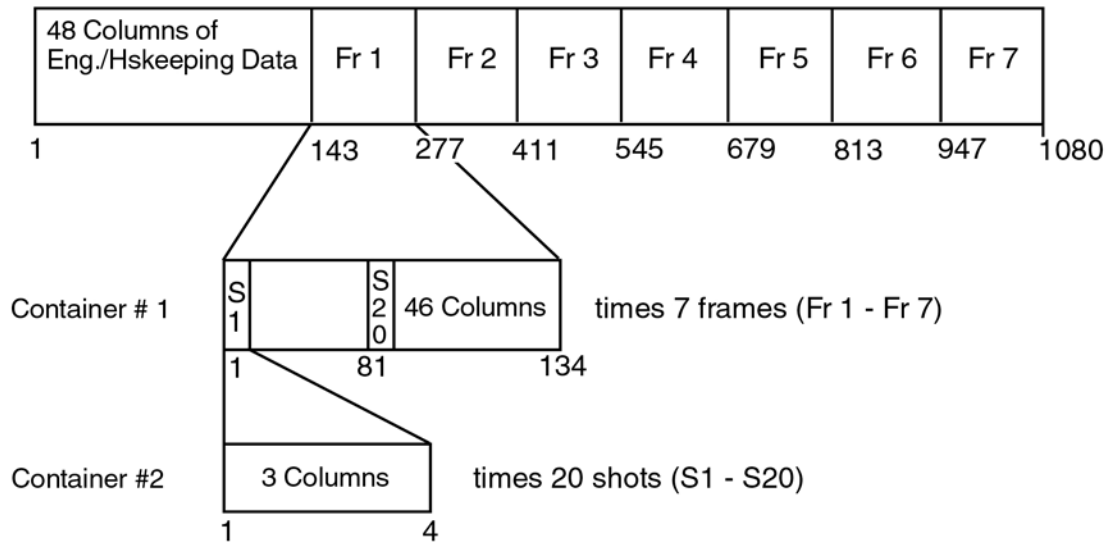

In the first CONTAINER, the keyword REPETITIONS is equal to 7. In the second CONTAINER, REPETITIONS equals 20. Both CONTAINER objects contain a collection of COLUMN objects. In most cases it is preferable to save space in the product label by placing COLUMN objects in a separate file and pointing to that file from within the CONTAINER object.

This attached label example describes the above TABLE structure using CONTAINER objects.

```

PDS_VERSION_ID          = PDS3
RECORD_TYPE             = FIXED_LENGTH
FILE_RECORDS            = 467
RECORD_BYTES            = 1080
LABEL_RECORDS           = 4
FILE_NAME                = "AEDR.A01"

^MOLA_SCIENCE_MODE_TABLE = 5
DATA_SET_ID              = "MO-M-MOLA-1-AEDR-L0-V1.0"
PRODUCT_ID               = "MOLA-AEDR-10010-0001"
SPACECRAFT_NAME          = MARS_OBSERVER
INSTRUMENT_ID            = MOLA
INSTRUMENT_NAME          = MARS_OBSERVER_LASER_ALTIMETER
TARGET_NAME              = MARS
SOFTWARE_NAME             = "BROWSER 17.1"
UPLOAD_ID                 = "5.3"
PRODUCT_RELEASE_DATE     = 1994-12-29T02:10:09.321
START_TIME                = 1994-09-29T04:12:43.983
STOP_TIME                 = 1994-09-29T06:09:54.221
SPACECRAFT_CLOCK_START_COUNT = "12345"
SPACECRAFT_CLOCK_STOP_COUNT = "12447"
PRODUCT_CREATION_TIME    = 1994-01-29T07:30:333
MISSION_PHASE_NAME       = MAPPING

```

```

ORBIT_NUMBER           = 0001
PRODUCER_ID           = MO_MOLA_TEAM
PRODUCER_FULL_NAME    = "DAVID E. SMITH"
PRODUCER_INSTITUTION_NAME = "GODDARD SPACE FLIGHT CENTER"
DESCRIPTION            = "This data product contains the
                        aggregation of MOLA telemetry packets by Orbit. All Experiment
                        Data Record Packets retrieved from the PDB are collected in this
                        data product. The AEDR data product is put together with the
                        Project-provided software tool Browser."

OBJECT                 = MOLA_SCIENCE_MODE_TABLE
INTERCHANGE_FORMAT    = BINARY
ROWS                  = 463
COLUMNS              = 97
ROW_BYTES             = 1080
^STRUCTURE            = "MOLASCI.FMT"
DESCRIPTION            = "This table is one of two that describe
                        the arrangement of information on the Mars Observer Laser
                        Altimeter (MOLA) Aggregated Engineering Data Record (AEDR). ..."

END_OBJECT            = MOLA_SCIENCE_MODE_TABLE
...
END

```

#### Contents of the MOLASCI.FMT file:

```

OBJECT                 = COLUMN
NAME                   = PACKET_ID
DATA_TYPE              = LSB_BIT_STRING
START_BYTE            = 1
BYTES                  = 2
VALID_MINIMUM         = 0
VALID_MAXIMUM         = 7
DESCRIPTION            = "Packet_id constitutes one of three
                        parts in the primary source information header applied by the
                        Payload Data System (PDS) to the MOLA telemetry packet at the time
                        of creation of the packet prior to transfer frame creation."

OBJECT                 = BIT_COLUMN
NAME                   = VERSION_NUMBER
BIT_DATA_TYPE         = UNSIGNED_INTEGER
START_BIT             = 1
BITS                   = 3
MINIMUM                = 0
MAXIMUM                = 7
DESCRIPTION            = "These bits identify Version 1 as the
                        Source Packet structure. These bits shall be set to '000'."
END_OBJECT            = BIT_COLUMN

OBJECT                 = BIT_COLUMN
NAME                   = SPARE
BIT_DATA_TYPE         = UNSIGNED_INTEGER

```

```

START_BIT           = 4
BITS                = 1
MINIMUM             = 0
MAXIMUM             = 0
DESCRIPTION         = "Reserved spare.  This bit shall be set
                      to '0'"
END_OBJECT          = BIT_COLUMN

OBJECT              = BIT_COLUMN
NAME                = SECONDARY_HEADER_FLAG
BIT_DATA_TYPE       = BOOLEAN
START_BIT           = 5
BITS                = 1
MINIMUM             = 0
MAXIMUM             = 0
DESCRIPTION         = "This flag signals the presence or
                      absence of a Secondary Header data structure within the Source
                      Packet.  This bit shall be set to '0' since no Secondary Header
                      formatting standards currently exist for Mars Observer."
END_OBJECT          = BIT_COLUMN

OBJECT              = BIT_COLUMN
NAME                = ERROR_STATUS
BIT_DATA_TYPE       = UNSIGNED_INTEGER
START_BIT           = 6
BITS                = 3
MINIMUM             = 0
MAXIMUM             = 7
DESCRIPTION         = "This field identifies in part the
                      individual application process within the spacecraft that created
                      the Source Packet data."
END_OBJECT          = BIT_COLUMN

OBJECT              = BIT_COLUMN
NAME                = INSTRUMENT_ID
BIT_DATA_TYPE       = UNSIGNED_INTEGER
START_BIT           = 9
BITS                = 8
MINIMUM             = 2#0100011#
MAXIMUM             = 2#0100011#
DESCRIPTION         = "This field identifies in part the
                      individual application process within the spacecraft that created
                      the Source Packet data.  00100011 is the bit pattern for MOLA."
END_OBJECT          = BIT_COLUMN
END_OBJECT          = COLUMN

...

OBJECT              = COLUMN
NAME                = COMMAND_ECHO
DATA_TYPE           = INTEGER
START_BYTE          = 125
BYTES               = 16
ITEMS               = 8

```

```

ITEM_BYTES           = 2
MINIMUM              = 0
MAXIMUM              = 65535
DESCRIPTION          = "First 8 command words received during
                        current packet, only complete commands are stored, MOLA specific
                        commands only. The software attempts to echo all valid commands.
                        If the command will fit in the room remaining in the..."
END_OBJECT           = COLUMN

OBJECT               = COLUMN
NAME                 = PACKET_VALIDITY_CHECKSUM
DATA TYPE           = INTEGER
START_BYTE          = 141
BYTES               = 2
MINIMUM              = 0
MAXIMUM              = 65535
DESCRIPTION          = "Simple 16 bit addition of entire packet
                        contents upon completion. This location is zeroed for addition.
                        This word is zeroed, then words 0-539 are added without carry to a
                        variable that is initially zero. The resulting lower 16 bits
                        are..."
END_OBJECT           = COLUMN

OBJECT               = CONTAINER
NAME                 = FRAME_STRUCTURE
^STRUCTURE           = "MOLASCFR.FMT" /*points to the columns*/
                        /*that make up the frame descriptors */
START_BYTE          = 143
BYTES               = 134
REPETITIONS         = 7
DESCRIPTION          = "The frame_structure container
                        represents the format of seven repeating groups of attributes in
                        this data product. The data product reflects science data
                        acquisition from seven different frames. Since the data from each
                        frame are ..."
END_OBJECT           = CONTAINER

```

#### Contents of the MOLASCFR.FMT FILE:

```

OBJECT               = CONTAINER
NAME                 = COUNTS
START_BYTE          = 1
BYTES               = 4
REPETITIONS         = 20
^STRUCTURE           = "MOLASCCT.FMT"
DESCRIPTION          = "This container has three sub-elements
                        (range to surface counts, 1st channel received pulse energy, and
                        2nd channel received pulse energy). The three sub-elements repeat
                        for each of 20 shots."
END_OBJECT           = CONTAINER

OBJECT               = COLUMN
NAME                 = SHOT_2_LASER_TRANSMITTER_POWR

```

```

DATA_TYPE           = UNSIGNED_INTEGER
START_BYTE         = 81
BYTES              = 1
MINIMUM            = 0
MAXIMUM            = 65535
DESCRIPTION        = "... "
END_OBJECT         = COLUMN

OBJECT              = COLUMN
NAME                = SHOT_1_LASER_TRANSMITTER_POWR
DATA_TYPE           = UNSIGNED_INTEGER
START_BYTE         = 82
BYTES              = 1
MINIMUM            = 0
MAXIMUM            = 65535
DESCRIPTION        = "... "
END_OBJECT         = COLUMN

OBJECT              = COLUMN
NAME                = SHOT_4_LASER_TRANSMITTER_POWR
DATA_TYPE           = UNSIGNED_INTEGER
START_BYTE         = 83
BYTES              = 1
MINIMUM            = 0
MAXIMUM            = 65535
DESCRIPTION        = "... "
END_OBJECT         = COLUMN

...

OBJECT              = COLUMN
NAME                = CH_3_2ND_HALF_FRAME_BKGRND_CN
DATA_TYPE           = UNSIGNED_INTEGER
START_BYTE         = 133
BYTES              = 1
MINIMUM            = 0
MAXIMUM            = 255
DESCRIPTION        = "The background energy or noise count
                      levels in channels 1, 2, 3, and 4 respectively by half-frame.
                      Pseudo log value of NOISE(1, 2, 3, 4) at the end of a half-frame
                      of current frame, 5.3 bit format. Plog base 2 of background count
                      sum..."
END_OBJECT         = COLUMN

OBJECT              = COLUMN
NAME                = CH_4_2ND_HALF_FRAME_BKGRND_CN
DATA_TYPE           = UNSIGNED_INTEGER
START_BYTE         = 134
BYTES              = 1
MINIMUM            = 0
MAXIMUM            = 255
DESCRIPTION        = "The background energy or noise count
                      levels in channels 1, 2, 3, and 4 respectively by half-frame.
                      Pseudo log value of NOISE(1, 2, 3, 4) at the end of a half-frame

```



```

of current frame, 5.3 bit format.  Plog base 2 of background count
sum..."
END_OBJECT = COLUMN

```

### Contents of the MOLASCCT.FMT FILE:

```

OBJECT = COLUMN
NAME = RANGE_TO_SURFACE_TIU_CNTRS
DATA_TYPE = MSB_INTEGER
START_BYTE = 1
BYTES = 2
DESCRIPTION = "The possible 20 valid frame laser shots
surface ranging measurements in Timing Interval Unit (TIU) counts.
The least significant 16 bits of TIU (SLTIU), stored for every
shot. B[0] = Bits 15-8 of TIU reading; B[1] = Bits 7-0 of ..."
END_OBJECT = COLUMN

OBJECT = COLUMN
NAME = FIRST_CH_RCVD_PULSE_ENRGY
DATA_TYPE = UNSIGNED_INTEGER
START_BYTE = 3
BYTES = 1
DESCRIPTION = "The level of return, reflected energy
as received by the first channel and matched filter to trigger.
This is a set of values for all possible 20 shots within the
frame.  Lowest numbered non-zero energy reading for each shot."
END_OBJECT = COLUMN

OBJECT = COLUMN
NAME = SECOND_CH_RCVD_PULSE_ENRGY
DATA_TYPE = UNSIGNED_INTEGER
START_BYTE = 4
BYTES = 1
DESCRIPTION = "The level of return, reflected energy
as received by the second channel and matched filter to trigger.
This is a set of values for all possible 20 shots within the
frame.  2nd lowest numbered non-zero energy reading for each
shot..."
END_OBJECT = COLUMN

```



END\_OBJECT

2255 North Gemini Drive  
Flagstaff, Arizona 86001 USA"  
= DATA\_PRODUCER

## A.10 DATA\_SUPPLIER

The DATA\_SUPPLIER object is an optional sub-object of the VOLUME object. The DATA\_SUPPLIER, as opposed to the DATA\_PRODUCER, is an individual or organization responsible for distributing the data sets and associated data to the science community.

### A.10.1 Required Keywords

1. INSTITUTION\_NAME
2. FACILITY\_NAME
3. FULL\_NAME
4. ADDRESS\_TEXT
5. TELEPHONE\_NUMBER
6. ELECTRONIC\_MAIL\_TYPE
7. ELECTRONIC\_MAIL\_ID

### A.10.2 Optional Keywords

1. DISCIPLINE\_NAME
2. NODE\_NAME

### A.10.3 Required Objects

None

### A.10.4 Optional Objects

None

### A.10.5 Example

The fragment below was extracted from the larger example which can be found under the VOLUME object.

```

OBJECT                = DATA_SUPPLIER
  INSTITUTION_NAME    = "NATIONAL SPACE SCIENCE DATA CENTER"
  FACILITY_NAME       = "NATIONAL SPACE SCIENCE DATA CENTER"
  FULL_NAME           = "NATIONAL SPACE SCIENCE DATA CENTER"
  DISCIPLINE_NAME     = "NATIONAL SPACE SCIENCE DATA CENTER"
  ADDRESS_TEXT        = "Code 633
                        Goddard Space Flight Center
                        Greenbelt, Maryland, 20771, USA"
  TELEPHONE_NUMBER    = "3012866695"
  ELECTRONIC_MAIL_TYPE = "NSI/DECNET"

```

```
ELECTRONIC_MAIL_ID      = "NSSDCA::REQUEST"  
END_OBJECT               = DATA_SUPPLIER
```

## **A.11 DIRECTORY**

The DIRECTORY object is used to define a hierarchical file organization on a linear (i.e., sequential) medium such as tape. The DIRECTORY object identifies all directories and subdirectories below the root level. It is a required sub-object of the VOLUME object for volumes delivered on sequential media.

Note: The root directory on a volume does not need to be explicitly defined with the DIRECTORY object.

Subdirectories are identified by defining DIRECTORY objects as sub-objects of the root DIRECTORY. Files within the directories and subdirectories are sequentially identified by using FILE objects with a SEQUENCE\_NUMBER value corresponding to their position on the medium. The SEQUENCE\_NUMBER value must be unique for each file on the medium.

### **A.11.1 Required Keywords**

1. NAME

### **A.11.2 Optional Keywords**

1. RECORD\_TYPE
2. SEQUENCE\_NUMBER

### **A.11.3 Required Objects**

1. FILE

### **A.11.4 Optional Objects**

1. DIRECTORY

### A.11.5 Example

The fragment below was extracted from the larger example which can be found under the VOLUME object.

```
OBJECT          = DIRECTORY
  NAME          = INDEX

OBJECT          = FILE
  FILE_NAME     = "INDXINFO.TXT"
  RECORD_TYPE   = STREAM
  SEQUENCE_NUMBER = 5
  END_OBJECT    = FILE

OBJECT          = FILE
  FILE_NAME     = "INDEX.LBL"
  RECORD_TYPE   = STREAM
  SEQUENCE_NUMBER = 6
  END_OBJECT    = FILE

OBJECT          = FILE
  FILE_NAME     = "INDEX.TAB"
  RECORD_TYPE   = FIXED_LENGTH
  RECORD_BYTES  = 512
  FILE_RECORDS  = 6822
  SEQUENCE_NUMBER = 7
  END_OBJECT    = FILE
END_OBJECT      = DIRECTORY
```

## A.12 DOCUMENT

*Note: This section is currently undergoing major revision. Please consult a PDS data engineer for the latest available information on document labelling.*

The DOCUMENT object is used to label a particular document that is provided on a volume to support an archived data product. A document can be made up of one or more files in a single format. For instance, a document may be comprised of as many TIFF files as there are pages in the document.

Multiple versions of a document can be supplied on a volume with separate formats, requiring a DOCUMENT object for each document version (i.e., OBJECT = TEX\_DOCUMENT and OBJECT = PS\_DOCUMENT when including both the TEX and Postscript versions of the same document).

PDS requires that at least one version of any document be plain ASCII text in order to allow users the capability to read, browse, or search the text without requiring software or text processing packages. This version can be plain, unmarked text, or ASCII text containing a markup language. (See the *Documentation* chapter of this document for more details.)

The DOCUMENT object contains keywords that identify and describe the document, provide the date of publication of the document, indicate the number of files comprising the document, provide the format of the document files, and identify the software used to compress or encode the document, as applicable.

DOCUMENT labels must be detached files unless the files are plain, unmarked text that will not be read by text or word processing packages. A DOCUMENT object for each format type of a document can be included in the same label file with pointers, such as ^TIFF\_DOCUMENT for a TIFF formatted document. (See example below.)

### A.12.1 Required Keywords

1. DOCUMENT\_NAME
2. DOCUMENT\_TOPIC\_TYPE
3. INTERCHANGE\_FORMAT
4. DOCUMENT\_FORMAT
5. PUBLICATION\_DATE

### A.12.2 Optional Keywords

1. ABSTRACT\_TEXT
2. DESCRIPTION



3. ENCODING\_TYPE
4. FILES

### A.12.3 Required Objects

None

### A.12.4 Optional Objects

None

### A.12.5 Example

The following example detached label, PDSUG.LBL, is for a Document provided in three formats: ASCII text, TIFF, and TEX.

```

PDS_VERSION_ID          = PDS3
RECORD_TYPE             = UNDEFINED

^ASCII_DOCUMENT         = "PDSUG.ASC"
^TIFF_DOCUMENT          = {"PDSUG001.TIF", "PDSUG002.TIF",
                          "PDSUG003.TIF", "PDSUG004.TIF" }
^TEX_DOCUMENT           = "PDSUG.TEX"

OBJECT                  = ASCII_DOCUMENT
  DOCUMENT_NAME         = "Planetary Data System Data Set Catalog
                        User's Guide"
  PUBLICATION_DATE      = 1992-04-13
  DOCUMENT_TOPIC_TYPE   = "USER'S GUIDE"
  INTERCHANGE_FORMAT    = ASCII
  DOCUMENT_FORMAT       = TEXT

DESCRIPTION              = "The Planetary Data System Data Set
  Catalog User's Guide describes the fundamentals of accessing,
  searching, browsing, and ordering data from the PDS Data Set Catalog
  at the Central Node. The text for this 4-page document is provided
  here in this plain, ASCII text file."
ABSTRACT_TEXT           = "The PDS Data Set Catalog is similar in
  function and purpose to a card catalog in a library. Use a Search
  screen to find data items, a List/Order screen to order data items,
  and the More menu option to see more information."
END_OBJECT              = ASCII_DOCUMENT

OBJECT                  = TIFF_DOCUMENT
  DOCUMENT_NAME         = "Planetary Data System Data Set Catalog
                        User's Guide"

```

```

DOCUMENT_TOPIC_TYPE      = "USER'S GUIDE"
INTERCHANGE_FORMAT      = BINARY
DOCUMENT_FORMAT         = TIFF
PUBLICATION_DATE       = 1992-04-13
FILES                   = 4
ENCODING_TYPE          = "CCITT/3"
DESCRIPTION             = "The Planetary Data System Data Set
  Catalog User's Guide describes the fundamentals of accessing,
  searching, browsing, and ordering data from the PDS Data Set Catalog
  at the Central Node.

  The 4-page document is provided here in 4 consecutive files, one
  file per page, in Tagged Image File Format (TIFF) using Group 3
  compression.  It has been successfully imported into WordPerfect
  5.0, FrameMaker, and Photoshop."
ABSTRACT_TEXT          = "The PDS Data Set Catalog is similar in
  function and purpose to a card catalog in a library.  Use a Search
  screen to find data items, a List/Order screen to order data items,
  and the More menu option to see more information."
END_OBJECT             = TIFF_DOCUMENT

OBJECT                 = TEX_DOCUMENT
DOCUMENT_NAME          = "Planetary Data System Data Set Catalog
  User's Guide"
DOCUMENT_TOPIC_TYPE    = "USER'S GUIDE"
INTERCHANGE_FORMAT     = ASCII
DOCUMENT_FORMAT        = TEX
PUBLICATION_DATE      = 1992-04-13
DESCRIPTION            = "The Planetary Data System Data Set
  Catalog User's Guide describes the fundamentals of accessing,
  searching, browsing, and ordering data from the PDS Data Set Catalog
  at the Central Node.

  The 4-page document is provided here in TeX format with all
  necessary macros included."
ABSTRACT_TEXT          = "The PDS Data Set Catalog is similar in
  function and purpose to a card catalog in a library.  Use a Search
  screen to find data items, a List/Order screen to order data items,
  and the More menu option to see more information."
END_OBJECT             = TEX_DOCUMENT
END

```

## A.13 ELEMENT (Primitive Data Object)

The ELEMENT object provides a means of defining a lowest-level component of a data object, and which can be stored in an integral multiple of 8-bit bytes. ELEMENT objects may be embedded in COLLECTION and ARRAY data objects. The optional START\_BYTE element identifies a location relative to the enclosing object. If not explicitly included, a START\_BYTE = 1 is assumed for the ELEMENT.

### A.13.1 Required Keywords

1. BYTES
2. DATA\_TYPE
3. NAME

### A.13.2 Optional Keywords

1. START\_BYTE
2. BIT\_MASK
3. DERIVED\_MAXIMUM
4. DERIVED\_MINIMUM
5. DESCRIPTION
6. FORMAT
7. INVALID\_CONSTANT
8. MINIMUM
9. MAXIMUM
10. MISSING\_CONSTANT
11. OFFSET
12. SCALING\_FACTOR
13. UNIT
14. VALID\_MINIMUM
15. VALID\_MAXIMUM

### A.13.3 Required Objects

None

### A.13.4 Optional Objects

None

### **A.13.5 Example**

Please refer to the example in the ARRAY Primitive object (Section A.2) for an example of the use of the ELEMENT object.

## A.14 FIELD

The FIELD object identifies a single variable-width field in a SPREADSHEET object.

Notes:

1. The only PDS data object that includes FIELD objects is the SPREADSHEET. FIELDS must not themselves contain embedded FIELD objects.
2. The DATA\_TYPE keyword is required to specify the data type of the values that are stored in the field when data are present.
3. A vector with two or more identically formatted components may be specified as a single FIELD by using the ITEM and ITEM\_BYTES elements. The ITEMS data element indicates the number of occurrences within the field (i.e., components in the vector).
4. If a FIELD contains multiple items, then the ITEM\_BYTES keyword is used to specify the maximum number of bytes any item in the set may have. ITEM\_BYTES does not include the quotation marks that enclose string items.
5. The BYTES keyword is used to specify the maximum size of the FIELD object, not including leading or trailing delimiters or line terminators. When a field contains items, the BYTES value is set to the product of the ITEM\_BYTES and ITEMS values plus the number of interior delimiter bytes (e.g., for three ASCII\_INTEGER items of three bytes each ITEMS = 3, ITEM\_BYTES=3, and BYTES= 11, which includes the two delimiters WITHIN the field but not the trailing delimiter).
6. The (optional) FORMAT element may be used to specify the format of FIELD data when they are present. The FORMAT specification applies to the maximum size of the field object, allowing shorter variations. For example, FORMAT = "F5.1" is consistent with each of the following:
  - ... ,127.1, ...
  - ... ,-12.7, ...
  - ... ,3.1, ...
  - ... ,3.01, ... and
  - ... ,, ...
7. Inclusion of data elements VALID\_MINIMUM and VALID\_MAXIMUM within FIELD object definitions is encouraged.
8. If data element MISSING\_CONSTANT is used, its meaning must be clearly stated since absence of a field value is the default indication of 'no data'.

### A.14.1 Required Keywords

1. BYTES
2. DATA\_TYPE
3. NAME

### A.14.2 Optional Keywords

1. DESCRIPTION
2. FIELD\_NUMBER
3. FORMAT
4. ITEM\_BYTES
5. ITEMS
6. UNIT
7. VALID\_MAXIMUM
8. VALID\_MINIMUM
9. PSDD

### A.14.3 Required Objects

None

### A.14.4 Optional Objects

1. ALIAS

### A.14.5 Example 1

The label fragment below shows a simple FIELD object from a SPREADSHEET object (see the SPREADSHEET section of this document).

```

OBJECT                = FIELD
  NAME                = "DETECTOR TEMPERATURE"
  FIELD_NUMBER        = 3
  BYTES               = 5
  DATA_TYPE          = "ASCII_REAL"
  FORMAT              = "F5.1"
  UNIT                = "KELVIN"
END_OBJECT            = FIELD

```

### A.14.6 Example 2

The fragment below shows two FIELDS containing multiple items. The first FIELD is a vector containing three ASCII\_INTEGER items: xx, yy, zz. The second FIELD contains three character items: "xx", "yy" and "zz". Note that the value of BYTES includes the comma delimiters between items, but the ITEM\_BYTES value does not.

```

OBJECT          = FIELD
  NAME          = "FIELD 1 - IX, IY, IZ"
  DATA_TYPE    = "ASCII_INTEGER"
  FIELD_NUMBER  = 1
  BYTES         = 8      /*includes item separating delimiters*/
  ITEMS         = 3      /* i.e. 17,15,27   or   1,2,3   */
  ITEM_BYTES    = 2      /* individual item maximum size in bytes */
  FORMAT        = "I2"
  MISSING_CONSTANT = -1
  DESCRIPTION   = "Raw values of FIELD 1.  IX, IY, and IZ represent
                  independent, non-negative measurements.  A value
                  of -1 denotes a measurement that could not be
                  processed."
END_OBJECT     = FIELD

OBJECT          = FIELD
  NAME          = "FIELD 2 - AX, AY,AZ"
  DATA_TYPE    = "CHARACTER"
  FIELD_NUMBER  = 2      /* One FIELD object precedes this object
*/
  BYTES         = 12     /* Doesn't include first/last quotes */
  ITEMS         = 3      /* i.e. "xx","yy","zz" */
  ITEM_BYTES    = 2
  FORMAT        = "A2"
END_OBJECT     = FIELD

```

## A.15 FILE

The FILE object is used in attached or detached labels to define the attributes or characteristics of a data file. In attached labels, the file object is also used to indicate boundaries between label records and data records in data files which have attached labels. The FILE object may be used in three ways:

1. As an implicit object in attached or detached labels. All detached label files and attached labels contain an implicit FILE object which starts at the top of the label and ends where the label ends. In these cases, the PDS recommends against using the NAME keyword to reference the file name. This label fragment shows the required FILE object elements as they typically appear in labels:

```
RECORD_TYPE      = FIXED_LENGTH
RECORD_BYTES     = 80
FILE_RECORDS     = 522
LABEL_RECORDS   = 10
```

For data products labelled using the implicit file object (e.g., in minimal labels) "DATA\_OBJECT\_TYPE = FILE" should be used in the DATA\_SET catalog object.

2. As an explicit object which is used when a file reference is needed in a combined detached or minimal label. In this case, the optional FILE\_NAME element is used to identify the file being referenced.

```
OBJECT           = FILE
FILE_NAME       = "IM10347.DAT"
RECORD_TYPE     = STREAM
FILE_RECORDS    = 1024
. . .
END_OBJECT      = FILE
```

For data products labelled using the explicit FILE object (e.g., in minimal labels) DATA\_OBJECT\_TYPE = FILE should be used in the DATA\_SET catalog object.

3. As an explicit object to identify specific files as sub-objects of the DIRECTORY in VOLUME objects. In this case, the optional FILE\_NAME element is used to identify the file being referenced on a tape archive volume.

```
OBJECT           = FILE
FILE_NAME       = "VOLDESC.CAT"
RECORD_TYPE     = STREAM
SEQUENCE_NUMBER = 1
END_OBJECT      = FILE
```



The keywords in the FILE object always describe the file being referenced, and not the file in which the keywords are contained (i.e., if the FILE object is used in a detached label file, the FILE object keywords describe the detached data file, not the label file which contains the keywords). For example, if a detached label for a data file is being created and the label will be in STREAM format, but the data will be stored in a file having FIXED\_LENGTH records, then the RECORD\_TYPE keyword in the label file must be given the value FIXED\_LENGTH.

The following table identifies data elements that are required (Req), optional (Opt), and not applicable (-) for various types of files

Labeling Method	Att	Det	Att	Det	Att	Det	Att	Det
RECORD_TYPE		FIXED_LENGTH		VARIABLE_LENGTH		STREAM		UNDEFINED
RECORD_BYTES	Req	Req	Rmax	Rmax	Omax	-	-	-
FILE_RECORDS	Req	Req	Req	Req	Opt	Opt	-	-
LABEL_RECORDS	Req	-	Req	-	Opt	-	-	-

### A.15.1 Required Keywords

#### 1. RECORD\_TYPE

(See above table for the conditions of use of additional required keywords)

### A.15.2 Optional Keywords

1. DESCRIPTION
2. ENCODING\_TYPE
3. FILE\_NAME (required only in minimal detached labels and tape archives)
4. FILE\_RECORDS (required only in minimal detached labels and tape archives)
5. INTERCHANGE\_FORMAT
6. LABEL\_RECORDS
7. RECORD\_BYTES
8. REQUIRED\_STORAGE\_BYTES
9. SEQUENCE\_NUMBER
10. UNCOMPRESSED\_FILE\_NAME

### A.15.3 Required Objects

None

## A.15.4 Optional Objects

None

## A.15.5 Example

Following is an example of a set of explicit FILE objects in a combined detached label. An additional example of the use of explicit FILE object can be found under the VOLUME object (Section A.29).

```

PDS_VERSION_ID           = PDS3
HARDWARE_MODEL_ID       = "SUN SPARC STATION"
OPERATING_SYSTEM_ID     = "SUN OS 4.1.1"
SPACECRAFT_NAME         = "VOYAGER 2"
INSTRUMENT_NAME         = "PLASMA WAVE RECEIVER"
MISSION_PHASE_NAME      = "URANUS ENCOUNTER"
TARGET_NAME             = URANUS
DATA_SET_ID             = "VG2-U-PWS-4-RDR-SA-48.0SEC-V1.0"
PRODUCT_ID              = "T860123-T860125"

OBJECT                   = FILE
  FILE_NAME              = "T860123.DAT"
  FILE_RECORDS           = 1800
  RECORD_TYPE            = FIXED_LENGTH
  RECORD_BYTES           = 105
  START_TIME             = 1986-01-23T00:00:00.000
  STOP_TIME              = 1986-01-24T00:00:00.000
  ^TIME_SERIES           = "T860123.DAT"

OBJECT                   = TIME_SERIES
  INTERCHANGE_FORMAT     = BINARY
  ROWS                   = 1800
  ROW_BYTES              = 105
  COLUMNS               = 19
  ^STRUCTURE             = "PWS_DATA.FMT"
  SAMPLING_PARAMETER_NAME = TIME
  SAMPLING_PARAMETER_UNIT = SECOND
  SAMPLING_PARAMETER_INTERVAL = 48.0
END_OBJECT              = TIME_SERIES
END_OBJECT              = FILE

OBJECT                   = FILE
  FILE_NAME              = "T860124.DAT"
  FILE_RECORDS           = 1800
  RECORD_TYPE            = FIXED_LENGTH
  RECORD_BYTES           = 105
  START_TIME             = 1986-01-24T00:00:00.000
  STOP_TIME              = 1986-01-25T00:00:00.000

```

```

^TIME_SERIES                = "T860124.DAT"

OBJECT                      = TIME_SERIES
  INTERCHANGE_FORMAT       = BINARY
  ROWS                     = 1800
  ROW_BYTES                = 105
  COLUMNS                 = 19
  ^STRUCTURE               = "PWS_DATA.FMT"
  SAMPLING_PARAMETER_NAME  = TIME
  SAMPLING_PARAMETER_UNIT  = SECOND
  SAMPLING_PARAMETER_INTERVAL = 48.0
END_OBJECT                 = TIME_SERIES
END_OBJECT                 = FILE

OBJECT                      = FILE
  FILE_NAME                = "T860125.DAT"
  FILE_RECORDS             = 1799
  RECORD_TYPE              = FIXED_LENGTH
  RECORD_BYTES             = 105
  START_TIME               = 1986-01-30T00:00:00.000
  STOP_TIME                = 1986-01-30T23:59:12.000
  ^TIME_SERIES             = "T860125.DAT"

OBJECT                      = TIME_SERIES
  INTERCHANGE_FORMAT       = BINARY
  ROWS                     = 1799
  ROW_BYTES                = 105
  COLUMNS                 = 19
  ^STRUCTURE               = "PWS_DATA.FMT"
  SAMPLING_PARAMETER_NAME  = TIME
  SAMPLING_PARAMETER_UNIT  = SECOND
  SAMPLING_PARAMETER_INTERVAL = 48.0
END_OBJECT                 = TIME_SERIES
END_OBJECT                 = FILE
END

```

## A.16 GAZETTEER\_TABLE

The GAZETTEER\_TABLE object is a specific type of TABLE object that provides information about the geographical features of a planet or satellite. It contains information about named features such as location, size, origin of feature name, and so on. The GAZETTEER\_TABLE contains one row for each named feature on the target body. The table is formatted so that it may be read directly by many data management systems on various host computers. All fields (columns) are separated by commas, and character fields are enclosed by double quotation marks. Each record consist of 480 bytes, with a carriage return/line feed sequence in bytes 479 and 480. This allows the table to be treated as a fixed length record file on hosts that support this file type and as a normal text file on other hosts.

Currently the PDS Imaging Node at the USGS is the data producer for all GAZETTEER\_TABLEs.

### A.16.1 Required Keywords

1. NAME
2. INTERCHANGE\_FORMAT
3. ROWS
4. COLUMNS
5. ROW\_BYTES
6. DESCRIPTION

### A.16.2 Optional Keywords

Any

### A.16.3 Required Objects

1. COLUMN

#### A.16.3.1 Required COLUMN Objects (NAME =)

TARGET\_NAME  
SEARCH\_FEATURE\_NAME  
DIACRITIC\_FEATURE\_NAME  
MINIMUM\_LATITUDE  
MAXIMUM\_LATITUDE  
CENTER\_LATITUDE

MINIMUM\_LONGITUDE  
 MAXIMUM\_LONGITUDE  
 CENTER\_LONGITUDE  
 LABEL\_POSITION\_ID  
 FEATURE\_LENGTH  
 PRIMARY\_PARENTAGE\_ID  
 SECONDARY\_PARENTAGE\_ID  
 MAP\_SERIAL\_ID  
 FEATURE\_STATUS\_TYPE  
 APPROVAL\_DATE  
 FEATURE\_TYPE  
 REFERENCE\_NUMBER  
 MAP\_CHART\_ID  
 FEATURE\_DESCRIPTION

### A.16.3.2 Required Keywords (for Required COLUMN Objects)

NAME  
 DATA\_TYPE  
 START\_BYTE  
 BYTES  
 FORMAT  
 UNIT  
 DESCRIPTION

### A.16.4 Optional Objects

None

### A.16.5 Example

PDS_VERSION_ID	=	PDS3
RECORD_TYPE	=	FIXED_LENGTH
RECORD_BYTES	=	480
FILE_RECORDS	=	1181
PRODUCT_ID	=	XYZ
TARGET_NAME	=	MARS
^GAZETTEER_TABLE	=	"GAZETTER.TAB"
OBJECT	=	GAZETTEER_TABLE
NAME	=	"PLANETARY NOMENCLATURE GAZETTEER"
INTERCHANGE_FORMAT	=	ASCII
ROWS	=	1181
COLUMNS	=	20
ROW_BYTES	=	480

DESCRIPTION = "The gazetteer (file: GAZETTER.TAB) is a table of geographical features for a planet or satellite. It contains information about a named feature such as location, size, origin of feature name, etc. The Gazetteer Table contains one row for each feature named on the target body. The table is formatted so that it may be read directly into many data management systems on various host computers. All fields (columns) are separated by commas, and character fields are preceded by double quotation marks. Each record consist of 480 bytes, with a carriage return/line feed sequence in bytes 479 and 480. This allows the table to be treated as a fixed length record file on hosts that support this file type and as a normal text file on other hosts."

OBJECT = COLUMN  
 NAME = TARGET\_NAME  
 DATA\_TYPE = CHARACTER  
 START\_BYTE = 2  
 BYTES = 20  
 FORMAT = "A20"  
 UNIT = "N/A"  
 DESCRIPTION = "The planet or satellite on which the feature is located."  
 END\_OBJECT = COLUMN

OBJECT = COLUMN  
 NAME = SEARCH\_FEATURE\_NAME  
 DATA\_TYPE = CHARACTER  
 START\_BYTE = 25  
 BYTES = 50  
 FORMAT = "A50"  
 UNIT = "N/A"  
 DESCRIPTION = "The geographical feature name with all diacritical marks stripped off. This name is stored in upper case only so that it can be used for sorting and search purposes. This field should not be used to designate the name of the feature because it does not contain the diacritical marks. Feature names not containing diacritical marks can often take on a completely different meaning and in some cases the meaning can be deeply offensive."  
 END\_OBJECT = COLUMN

OBJECT = COLUMN  
 NAME = DIACRITIC\_FEATURE\_NAME  
 DATA\_TYPE = CHARACTER  
 START\_BYTE = 78  
 BYTES = 100  
 FORMAT = "A100"  
 UNIT = "N/A"  
 DESCRIPTION = "The geographical feature name containing standard diacritical information. A detailed description of the diacritical mark formats are described in the gazetteer documentation."

## DIACRITICALS USED IN THE TABLE

The word diacritic comes from a Greek word meaning to separate. It refers to the accent marks employed to separate, or distinguish, one form of pronunciation of a vowel or consonant from another.

This note is included to familiarize the user with the codes used to represent diacriticals found in the table, and the values usually associated with them. In the table, the code for a diacritical is preceded by a backslash and is followed, without a space, by the letter it is modifying.

This note is organized as follows: the code is listed first, followed by the name of the accent mark, if applicable, a brief description of the appearance of the diacritical and a short narrative on its usage.

acute accent; a straight diagonal line extending from upper right to lower left. The acute accent is used in most languages to lengthen a vowel; in some, such as Oscan, to denote an open vowel. The acute is also often used to indicate the stressed syllable; in some transcriptions it indicates a palatalized consonant.

diaeresis or umlaut; two dots surmounting the letter. In Romance languages and English, the diaeresis is used to indicate that consecutive vowels do not form a diphthong (see below); in modern German and Scandinavian languages, it denotes palatalization of vowels.

circumflex; a chevron or inverted 'v' shape, with the apex at the top. Used most often in modern languages to indicate lengthening of a vowel.

tilde; a curving or waving line above the letter. The tilde is a form of circumflex. The tilde is used most often in Spanish to form a palatalized n as in the word 'ano', pronounced 'anyo'. It is also used occasionally to indicate nasalized vowels.

macron; a straight line above the letter. The macron is used almost universally to lengthen a vowel.

breve; a concave semicircle or 'u' shape surmounting the letter. Originally used in Greek, the breve indicates a short vowel.

a small circle or 'o' above the letter. Frequently used in Scandinavian languages to indicate a broad 'o'.

e diphthong or ligature; transcribed as two letters in contact with each other. The diphthong is a combination of vowels that are pronounced together.

cedilla; a curved line surmounted by a vertical line, placed at the bottom of the letter. The cedilla is used in Spanish and French to denote a dental, or soft, 'c'. In the new Turkish transcription,

'c' cedilla has the value of English 'ch'. In Semitic languages, the cedilla under a consonant indicates that it is emphatic.

check or inverted circumflex; a 'v' shape above the letter. This accent is used widely in Slavic languages to indicate a palatal articulation, like the consonant sounds in the English words chapter and shoe and the 'zh' sound in pleasure.

a single dot above the letter. This diacritical denotes various things; in Lithuanian, it indicates a close long vowel. In Sanskrit, when used with 'n', it is a velar sound, as in the English 'sink'; in Irish orthography, it indicates a fricative consonant (see below).

accent grave; a diagonal line (above the letter) extending from upper left to lower right. The grave accent is used in French, Spanish and Italian to denote open vowels.

fricative; a horizontal line through a consonant. A fricative consonant is characterized by a frictional rustling of the breath as it is emitted."

```

END_OBJECT                = COLUMN

OBJECT                    = COLUMN
  NAME                    = MINIMUM_LATITUDE
  DATA_TYPE              = REAL
  START_BYTE              = 180
  BYTES                   = 7
  FORMAT                  = "F7.2"
  UNIT                    = DEGREE
  DESCRIPTION             = "The minimum_latitude element specifies
the southernmost latitude of a spatial area, such as a map, mosaic,
bin, feature, or region."
END_OBJECT                = COLUMN

OBJECT                    = COLUMN
  NAME                    = MAXIMUM_LATITUDE
  DATA_TYPE              = REAL
  START_BYTE              = 188
  BYTES                   = 7
  FORMAT                  = "F7.2"
  UNIT                    = DEGREE
  DESCRIPTION             = "The maximum_latitude element specifies
the northernmost latitude of a spatial area, such as a map, mosaic,
bin, feature, or region."
END_OBJECT                = COLUMN

OBJECT                    = COLUMN
  NAME                    = CENTER_LATITUDE
  DATA_TYPE              = REAL
  START_BYTE              = 196
  BYTES                   = 7
  FORMAT                  = "F7.2"

```



```

UNIT = DEGREE
DESCRIPTION = "The center latitude of the feature."
END_OBJECT = COLUMN

OBJECT = COLUMN
NAME = MINIMUM_LONGITUDE
DATA_TYPE = REAL
START_BYTE = 204
BYTES = 7
FORMAT = "F7.2"
UNIT = DEGREE
DESCRIPTION = "The minimum_longitude element specifies the easternmost latitude of a spatial area, such as a map, mosaic, bin, feature, or region. "
END_OBJECT = COLUMN

OBJECT = COLUMN
NAME = MAXIMUM_LONGITUDE
DATA_TYPE = REAL
START_BYTE = 212
BYTES = 7
FORMAT = "F7.2"
UNIT = DEGREE
DESCRIPTION = "The maximum_longitude element specifies the westernmost longitude of a spatial area, such as a map, mosaic, bin, feature, or region. "
END_OBJECT = COLUMN

OBJECT = COLUMN
NAME = CENTER_LONGITUDE
DATA_TYPE = REAL
START_BYTE = 220
BYTES = 7
FORMAT = "F7.2"
UNIT = DEGREE
DESCRIPTION = "The center longitude of the feature."
END_OBJECT = COLUMN

OBJECT = COLUMN
NAME = LABEL_POSITION_ID
DATA_TYPE = CHARACTER
START_BYTE = 229
BYTES = 2
FORMAT = "A2"
UNIT = "N/A"
DESCRIPTION = "The suggested plotting position of the feature name (UL=Upper left, UC=Upper center, UR=Upper right, CL=Center left, CR=Center right, LL=Lower left, LC=Lower center, LR=Lower right). This field is used to instruct the plotter where to place the typographical label with respect to the center of the feature. This code is used to avoid crowding of names in areas where there is a high density of named features."
END_OBJECT = COLUMN

```

```

OBJECT                = COLUMN
  NAME                = FEATURE_LENGTH
  DATA_TYPE          = REAL
  START_BYTE          = 233
  BYTES               = 8
  FORMAT              = "F8.2"
  UNIT                = KILOMETER
  DESCRIPTION         = "The longer or longest dimension of an
object. For the Gazetteer usage, this field refers to the length of
the named feature."
END_OBJECT            = COLUMN

OBJECT                = COLUMN
  NAME                = PRIMARY_PARENTAGE_ID
  DATA_TYPE          = CHARACTER
  START_BYTE          = 243
  BYTES               = 2
  FORMAT              = "A2"
  UNIT                = "N/A"
  DESCRIPTION         = "This field contains the primary origin
of the feature name (i.e. where the name originated). It contains
a code for the continent or country origin of the name. Please see
Appendix 5 of the gazetteer documentation (GAZETTER.TXT) for a
definition of the codes used to define the continent or country."
END_OBJECT            = COLUMN

OBJECT                = COLUMN
  NAME                = SECONDARY_PARENTAGE_ID
  DATA_TYPE          = CHARACTER
  START_BYTE          = 248
  BYTES               = 2
  FORMAT              = "A2"
  UNIT                = "N/A"
  DESCRIPTION         = "This field contains the secondary
origin of the feature name. It contains a code for a country, state,
territory, or ethnic group. Please see Appendix 5 of the gazetteer
documentation (GAZETTER.TXT) for a defintion of the codes in this
field."

END_OBJECT            = COLUMN

OBJECT                = COLUMN
  NAME                = MAP_SERIAL_ID
  DATA_TYPE          = CHARACTER
  START_BYTE          = 253
  BYTES               = 6
  FORMAT              = "A6"
  UNIT                = "N/A"
  DESCRIPTION         = "The identification of the map that
contains the named feature. This field represents the map serial
number of the map publication used for ordering maps from the U.S.
Geological Survey. The map identified in this field best portrays
the named feature."
END_OBJECT            = COLUMN

```

```

OBJECT                = COLUMN
  NAME                = FEATURE_STATUS_TYPE
  DATA_TYPE          = CHARACTER
  START_BYTE          = 262
  BYTES                = 12
  FORMAT              = "A12"
  UNIT                = "N/A"
  DESCRIPTION          = "The IAU approval status of the named
feature. Permitted values are 'PROPOSED', 'PROVISIONAL', 'IAU-
APPROVED', and 'DROPPED'. Dropped names have been disallowed by the
IAU. However, these features have been included in the gazetteer for
historical purposes. Some named features that are disallowed by the
IAU may commonly be used on some maps."
END_OBJECT            = COLUMN

```

```

OBJECT                = COLUMN
  NAME                = APPROVAL_DATE
  DATA_TYPE          = INTEGER
  START_BYTE          = 276
  BYTES                = 4
  FORMAT              = "I4"
  UNIT                = "N/A"
  DESCRIPTION          = "Date at which an object has been
approved by the officially sanctioned organization. This field
contains the year the IAU approved the feature name."
END_OBJECT            = COLUMN

```

```

OBJECT                = COLUMN
  NAME                = FEATURE_TYPE
  DATA_TYPE          = CHARACTER
  START_BYTE          = 282
  BYTES                = 20
  FORMAT              = "A20"
  UNIT                = "N/A"
  DESCRIPTION          = "The feature type identifies the type of
a particular feature, according to IAU standards. Examples are
'CRATER', 'TESSERA', 'TERRA', etc. See Appendix 7 of the gazetteer
documentation (GAZETTER.TXT).

```

#### DESCRIPTOR TERMS (FEATURE TYPES)

FEATURE	DESCRIPTION
ALBEDO FEATURE	Albedo feature
CATENA	Chain of craters
CAVUS	Hollows, irregular depressions
CHAOS	Distinctive area of broken terrain
CHASMA	Canyon
COLLES	Small hill or knob
CORONA	Ovoid-shaped feature
CRATER	Crater
DORSUM	Ridge
ERUPTIVE CENTER	Eruptive center
FACULA	Bright spot

FLEXUS	Cusped linear feature
FLUCTUS	Flow terrain
FOSSA	Long, narrow, shallow depression
LABES	Landslide
LABYRINTHUS	Intersecting valley complex
LACUS	Lake
LARGE RINGED FEATURE	Large ringed feature
LINEA	Elongate marking
MACULA	Dark spot
MARE	Sea
MENSA	Mesa, flat-topped elevation
MONS	Mountain
OCEANUS	Ocean
PALUS	Swamp
PATERA	Shallow crater; scalloped, complex edge
PLANITIA	Low plain
PLANUM	Plateau or high plain
PROMONTORIUM	Cape
REGIO	Region
RIMA	Fissure
RUPES	Scarp
SCOPULUS	Lobate or irregular scarp
SINUS	Bay
SULCUS	Subparallel furrows and ridges
TERRA	Extensive land mass
TESSERA	Tile; polygonal ground
THOLUS	Small domical mountain or hill
UNDAE	Dunes
VALLIS	Sinuuous valley
VASTITAS	Widespread lowlands
VARIABLE FEATURE	Variable feature "
END_OBJECT	= COLUMN
OBJECT	= COLUMN
NAME	= REFERENCE_NUMBER
DATA_TYPE	= INTEGER
START_BYTE	= 304
BYTES	= 4
FORMAT	= "I4"
UNIT	= "N/A"
DESCRIPTION	= "Literature reference from which the spelling and description of the feature name was derived. See Appendix 6 of the gazetteer documentation (GAZETTER.TXT)."
END_OBJECT	= COLUMN
OBJECT	= COLUMN
NAME	= MAP_CHART_ID
DATA_TYPE	= CHARACTER
START_BYTE	= 310
BYTES	= 6
FORMAT	= "A6"
UNIT	= "N/A"

```
DESCRIPTION          = "This field contains the abbreviation of
the map designator or chart identification (example MC-19, MC-18,
etc.)."
END_OBJECT           = COLUMN

OBJECT               = COLUMN
  NAME                = FEATURE_DESCRIPTION
  DATA_TYPE          = CHARACTER
  START_BYTE         = 319
  BYTES              = 159
  FORMAT              = "A159"
  UNIT                = "N/A"
  DESCRIPTION         = "Short description of the feature name."
END_OBJECT           = COLUMN
END_OBJECT           = GAZETTEER_TABLE
END
```

## A.17 HEADER

The HEADER object is used to identify and define the attributes of commonly used header data structures such as VICAR or FITS. These structures are usually system or software specific and are described in detail in a referenced description text file. The use of BYTES within the header object refers to the number of bytes for the entire header, not a single record.

### A.17.1 Required Keywords

1. BYTES
2. HEADER\_TYPE

### A.17.2 Optional Keywords

1. DESCRIPTION
2. INTERCHANGE\_FORMAT
3. RECORDS

### A.17.3 Required Objects

None

### A.17.4 Optional Objects

None

### A.17.5 Example

The following example shows the detached label file “TIMTC02A.LBL”. The label describes the data product file “TIMTC02A.IMG” which contains a HEADER object followed by an IMAGE object.

```
PDS_VERSION_ID          = PDS3

/* PDS label for a TIMS image */

RECORD_TYPE              = FIXED_LENGTH
RECORD_BYTES             = 638
FILE_RECORDS             = 39277

/* Pointers to objects */
```

```

^IMAGE_HEADER      = ("TIMTC02A.IMG",1)
^IMAGE             = ("TIMTC02A.IMG",2)

/* Image description */

DATA_SET_ID       = "C130-E-TIMS-2-EDR-IMAGE-V1.0"
PRODUCT_ID        = "TIMTC02A"
INSTRUMENT_HOST_NAME = "NASA C-130 AIRCRAFT"
INSTRUMENT_NAME    = "THERMAL INFRARED MULTISPECTRAL SCANNER"
TARGET_NAME       = EARTH
FEATURE_NAME       = "TRAIL CANYON FAN"
START_TIME        = 1989-09-29T21:47:35
STOP_TIME         = 1989-09-29T21:47:35
CENTER_LATITUDE   = 36.38
CENTER_LONGITUDE  = 116.96
INCIDENCE_ANGLE   = 0.0
EMISSION_ANGLE    = 0.0

/* Description of objects */

OBJECT            = IMAGE_HEADER
  BYTES           = 638
  RECORDS         = 1
  HEADER_TYPE     = VICAR2
  INTERCHANGE_FORMAT = BINARY
  ^DESCRIPTION    = "VICAR2.TXT"
END_OBJECT       = IMAGE_HEADER

OBJECT            = IMAGE
  LINES           = 6546
  LINE_SAMPLES    = 638
  SAMPLE_TYPE     = UNSIGNED_INTEGER
  SAMPLE_BITS     = 8
  SAMPLE_BIT_MASK = 2#11111111#
  BANDS           = 6
  BAND_STORAGE_TYPE = LINE_INTERLEAVED
END_OBJECT       = IMAGE
END

```

## A.18 HISTOGRAM

The HISTOGRAM object is a sequence of numeric values that provides the number of occurrences of a data value or a range of data values in a data object. The number of items in a histogram will normally be equal to the number of distinct values allowed in a field of the data object. For example, an 8-bit integer field can have a maximum of 256 values, and would result in a 256 item histogram. HISTOGRAMs may be used to bin data, in which case an offset and scaling factor indicate the dynamic range of the data represented.

The following equation allows the calculation of the range of each bin in the histogram:

$$\text{bin\_lower\_boundary} = \text{bin\_element} * \text{SCALING\_FACTOR} + \text{OFFSET}$$

### A.18.1 Required Keywords

1. ITEMS
2. DATA\_TYPE
3. ITEM\_BYTES

### A.18.2 Optional Keywords

1. BYTES
2. INTERCHANGE\_FORMAT
3. OFFSET
4. SCALING\_FACTOR

### A.18.3 Required Objects

None

### A.18.4 Optional Objects

None



### A.18.5 Example

```

PDS_VERSION_ID                = PDS3

/*          FILE FORMAT AND LENGTH */

RECORD_TYPE                   = FIXED_LENGTH
RECORD_BYTES                  = 956
FILE_RECORDS                  = 965
LABEL_RECORDS                 = 3

/*          POINTERS TO START RECORDS OF OBJECTS IN FILE */

^IMAGE_HISTOGRAM              = 4
^IMAGE                        = 6

/*          IMAGE DESCRIPTION */

DATA_SET_ID                   = "VO1/VO2-M-VIS-5-DIM-V1.0"
PRODUCT_ID                    = "MG15N022-GRN-666A"
SPACECRAFT_NAME               = VIKING_ORBITER_1
TARGET_NAME                   = MARS
START_TIME                    = 1978-01-14T02:00:00
STOP_TIME                     = 1978-01-14T02:00:00
SPACECRAFT_CLOCK_START_TIME   = UNK
SPACECRAFT_CLOCK_STOP_TIME    = UNK
PRODUCT_CREATION_TIME         = 1995-01-01T00:00:00
ORBIT_NUMBER                   = 666
FILTER_NAME                   = GREEN
IMAGE_ID                      = "MG15N022-GRN-666A"
INSTRUMENT_NAME               = {VISUAL_IMAGING_SUBSYSTEM_CAMERA_A,
                                VISUAL_IMAGING_SUBSYSTEM_CAMERA_B}
NOTE                          = "MARS MULTI-SPECTRAL MDIM SERIES"

/* SUN RAYS EMISSION, INCIDENCE, AND PHASE ANGLES OF IMAGE CENTER*/

SOURCE_PRODUCT_ID             = "666A36"
EMISSION_ANGLE                = 21.794
INCIDENCE_ANGLE               = 66.443
PHASE_ANGLE                   = 46.111

/*          DESCRIPTION OF OBJECTS CONTAINED IN FILE */

OBJECT                        = IMAGE_HISTOGRAM
  ITEMS                       = 256
  DATA_TYPE                  = VAX_INTEGER
  ITEM_BYTES                  = 4
END_OBJECT                    = IMAGE_HISTOGRAM

OBJECT                        = IMAGE
  LINES                       = 960
  LINE_SAMPLES                = 956
  SAMPLE_TYPE                 = UNSIGNED_INTEGER
  SAMPLE_BITS                 = 8
  SAMPLE_BIT_MASK             = 2#11111111#
  CHECKSUM                    = 65718982

/*  I/F = SCALING_FACTOR*DN + OFFSET, CONVERT TO INTENSITY/FLUX */

```

```
SCALING_FACTOR          = 0.001000
OFFSET                  = 0.0

/* OPTIMUM COLOR STRETCH FOR DISPLAY OF COLOR IMAGES */

STRETCHED_FLAG          = FALSE
STRETCH_MINIMUM         = ( 53, 0)
STRETCH_MAXIMUM         = (133,255)
END_OBJECT              = IMAGE

END
```

## A.19 HISTORY

A HISTORY object is a dynamic description of the history of one or more associated data objects in a file. It supplements the essentially static description contained in the PDS label.

The HISTORY object contains text in a format similar to that of the ODL statements used in the label. It identifies previous computer manipulation of the principal data object(s) in the file. It includes an identification of the source data, processes performed, processing parameters, as well as dates and times of processing. It is intended that the history be available for display, be dynamically extended by any process operating on the data, and be automatically propagated to the resulting data file. Eventually, it might be extracted for loading in detailed level catalogs of data set contents.

The HISTORY object is structured as a series of History Entries, one for each process which has operated on the data. Each entry contains a standard set of ODL element assignment statements, delimited by “GROUP = *program\_name*” and “END\_GROUP = *program\_name*” statements. A subgroup in each entry, delimited by “GROUP = PARAMETERS” and “END\_GROUP = PARAMETERS”, contains statements specifying the values of all parameters of the program.

### A.19.1 HISTORY ENTRY ELEMENTS

Attribute	Description
VERSION_DATE	Program version date, ISO standard format.
DATE_TIME	Run date and time, ISO standard format.
NODE_NAME	Network name of computer.
USER_NAME	Username.
SOFTWARE_DESC	Program-generated (brief) description.
USER_NOTE	User-supplied (brief) description.

Unlike the above elements, the names of the parameters defined in the PARAMETERS subgroup are uncontrolled, and must only conform to the program.

The last entry in a HISTORY object is followed by an END statement. The HISTORY object, by convention, follows the PDS label of the file, beginning on a record boundary, and is located by a pointer statement in the label. There are no required elements for the PDS label description of the object; it is represented in the label only by the pointer statement, and OBJECT = HISTORY and END\_OBJECT = HISTORY statements.

The HISTORY capability has been implemented as part of the Integrated Software for Imaging Spectrometers (ISIS) system (see QUBE object definition). ISIS QUBE applications add their own entries to the QUBE file’s cumulative HISTORY object. ISIS programs run under NASA’s TAE (Transportable Applications Executive) system, and are able to automatically insert all

parameters of their TAE procedure into the HISTORY entry created by the program. Consult the ISIS System Design document for details and limitations imposed by that system. (See the QUBE object description for further references.)

### **A.19.2 Required Keywords**

None

### **A.19.3 Optional Keywords**

None

### **A.19.4 Required Objects**

None

### **A.19.5 Optional Objects**

None

### **A.19.6 Example**

The following single-entry HISTORY object is from a Vicar-generated PDS-labeled QUBE file. (See the QUBE object example.) There is only one entry because the QUBE (or rather its label) was generated by a single program, VISIS. A QUBE generated by multiple ISIS programs would have multiple history entries, represented by multiple GROUPs in the HISTORY object.

The diagram following illustrates the placement of the example HISTORY object within a QUBE data product with an attached PDS label.

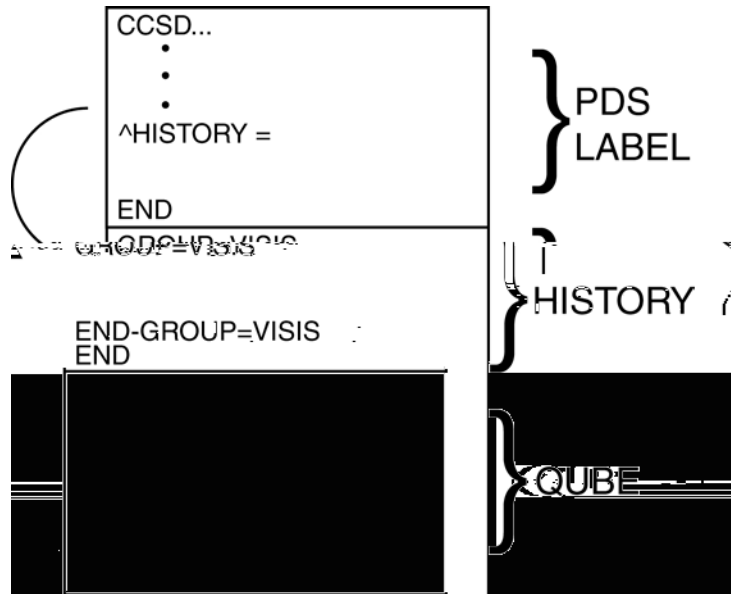

```

OBJECT                = HISTORY
GROUP                 = VISIS

VERSION_DATE          = 1990-11-08
DATE_TIME             = 1991-07-25T10:12:52
SOFTWARE_DESC         = "ISIS cube file with PDS label has
                        been generated as systematic product by MIPL using the following
                        programs:

                        NIMSMERGE to create EDR's;
                        NIMSCMM to create the merged mosaic & geometry cube;
                        HIST2D to create a two-dimensional histogram;
                        SPECPLOT to create the spectral plots;
                        TRAN, F2, and INSERT3D to create the SII cube;
                        VISIS to create the ISIS cube."
USER_NOTE              = "VPDIN1/ Footprint, Limbfit,
                        Height=50"

GROUP                 = PARAMETERS
  EDR_FILE_NAME        = " "
                        /*EDR accessed through MIPL Catalog*/
  IMAGE_ID             = NULL
  SPICE_FILE_NAME      = "N/A"
  SPIKE_FILE_NAME      = "MIPL: [MIPL.GLL] BOOM_OBSCURATION.NIM"
  DARK_VALUE_FILE_NAME = "N/A"
  CALIBRATION_FILE_NAME = "NDAT:NIMSGS2.CAL"
  MERGED_MOSAIC_FILE_NAME = "NDAT:VPDIN1_DN_FP_LF_H50.CUB"
  DARK_INTERPOLATION_TYPE = NOUPDAT
  PHOTOMETRIC_CORRECTION_TYPE = NONE
  CUBE_NIMSEL_TYPE     = NOCAL
  BINNING_TYPE         = FOOTPRNT
  FILL_BOX_SIZE        = 0
  FILL_MIN_VALID_PIXELS = 0
  SUMMARY_IMAGE_RED_ID = 0

```

```
SUMMARY_IMAGE_GREEN_ID      = 0
SUMMARY_IMAGE_BLUE_ID       = 0
ADAPT_STRETCH_SAT_FRAC      = 0.000000
ADAPT_STRETCH_SAMP_FRAC     = 0.000000
RED_STRETCH_RANGE           = ( 0, 0)
GREEN_STRETCH_RANGE         = ( 0, 0)
BLUE_STRETCH_RANGE          = ( 0, 0)
END_GROUP                   = PARAMETERS
END_GROUP                    = VISIS
END_OBJECT                   = HISTORY
END
```

## A.20 IMAGE

An IMAGE object is a two-dimensional array of values, all of the same type, each of which is referred to as a *sample*. IMAGE objects are normally processed with special display tools to produce a visual representation of the samples by assigning brightness levels or display colors to the values. An IMAGE consists of a series of lines, each containing the same number of samples.

The required IMAGE keywords define the parameters for simple IMAGE objects:

- LINES is the number of lines in the image.
- LINE\_SAMPLES is the number of samples in each line.
- SAMPLE\_BITS is the number of bits in each individual sample.
- SAMPLE\_TYPE defines the sample data type.

In more complex images, each individual line may have some attached data which are not part of the image itself (engineering data, checksums, time tags, etc.). In this case the additional, non-image parameters are accounted for as either LINE\_PREFIX\_BYTES or LINE\_SUFFIX\_BYTES, depending on whether they occur before or after the image samples in the line. These keywords indicate the total number of bytes used for the additional data, so that software processing the image can clip these bytes before attempting to display or manipulate the image. The structure of the prefix or suffix bytes is most often defined by a TABLE object (in the same label), which will itself have ROW\_SUFFIX\_BYTES or ROW\_PREFIX\_BYTES, to allow table-processing software to skip over the image data. Figure A.1 illustrates the layout of prefix and suffix bytes around an image.

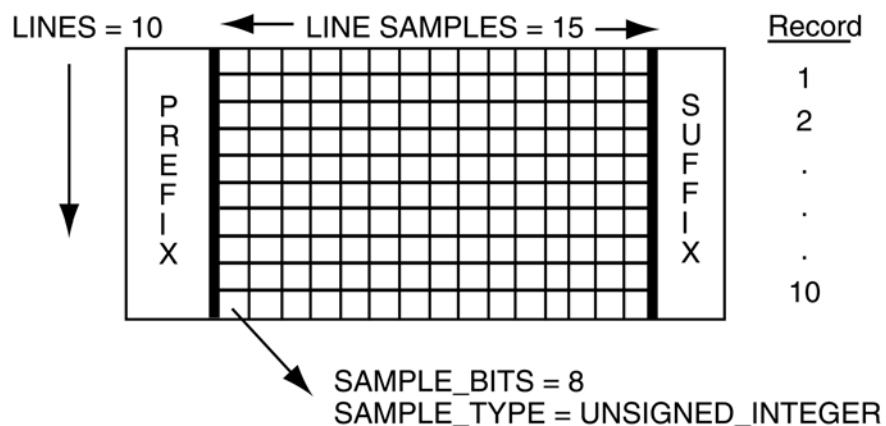

*Figure A.1 – Prefix and Suffix Bytes Attached to an Image*

Sometimes a single image is composed of several bands of data. For example, a color image for video display may actually consist of three copies of the image: one in red, one in green and one in blue. Each logical sample corresponds to one value for each of the bands. In this case, the keyword BANDS is used to indicate the presence of multiple bands of data.

BAND\_STORAGE\_TYPE indicates how the banded values are organized:

- SAMPLE\_INTERLEAVED means that in each line, all band values for each sample are adjacent in the line. So in the above example of an RGB image, each line would look like this (numbers are sample numbers, RGB = red, green, blue):

```
1R 1G 1B  2R 2G 2B  3R 3G 3B  ...
```

- LINE\_INTERLEAVED means that successive lines contain the band values for corresponding samples. Continuing with the RGB example, the first physical lines in the image data would represent the first display line of the image, first in red, then green, then blue:

```
1R 2R 3R 4R  ...
1G 2G 3G 4G  ...
1B 2B 3B 4B  ...
```

By default, IMAGE objects should be displayed so that the lines are drawn from left to right and top to bottom. Other organizations can be indicated by using the LINE\_DISPLAY\_DIRECTION and SAMPLE\_DISPLAY\_DIRECTION keywords. Figure A.2 illustrates band storage schemes and the related keyword values.



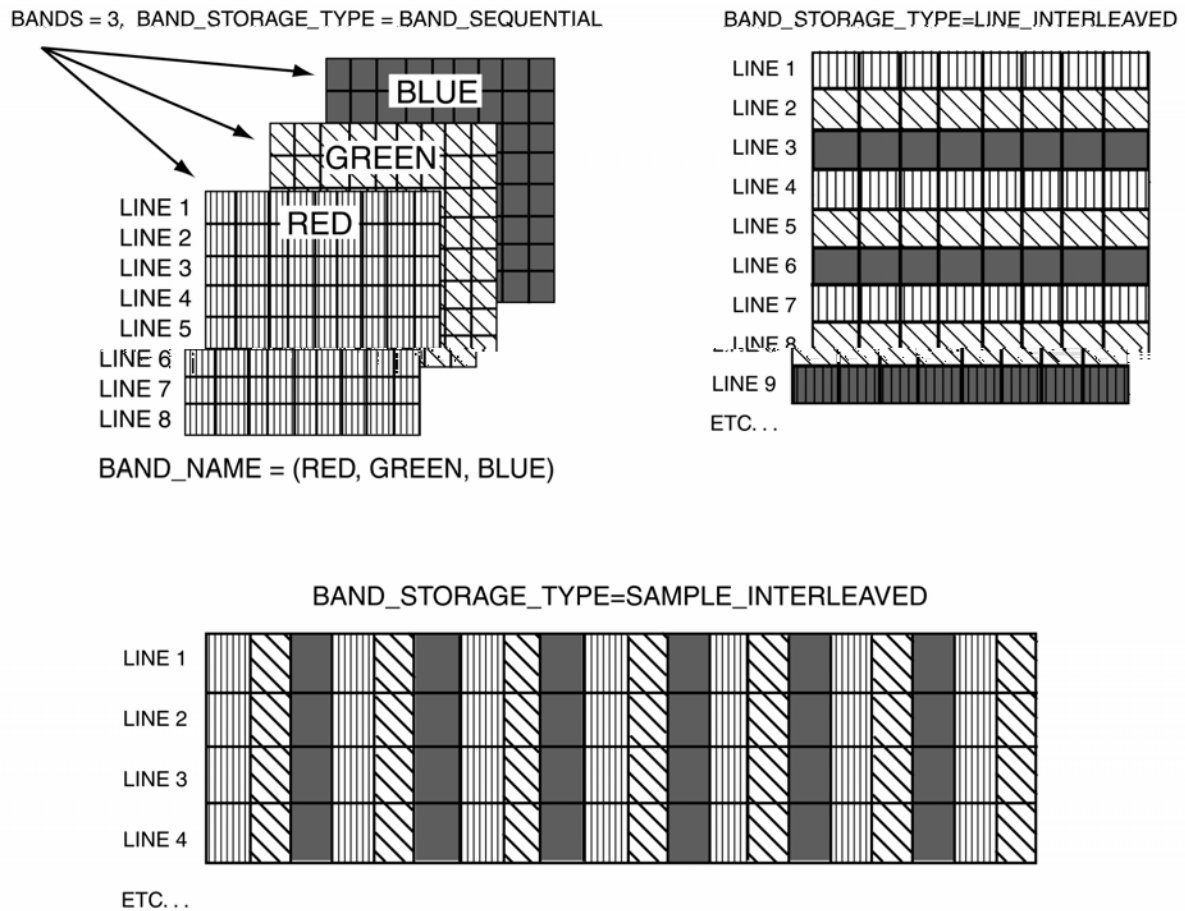

*Figure A.2 – Keywords for a Multi-Band Image*

### A.20.1 Required Keywords

1. LINES
2. LINE\_SAMPLES
3. SAMPLE\_TYPE
4. SAMPLE\_BITS

### A.20.2 Optional Keywords

1. BAND\_SEQUENCE
2. BAND\_STORAGE\_TYPE
3. BANDS
4. CHECKSUM
5. DERIVED\_MAXIMUM

6. DERIVED\_MINIMUM
7. DESCRIPTION
8. ENCODING\_TYPE
9. FIRST\_LINE
10. FIRST\_LINE\_SAMPLE
11. INVALID\_CONSTANT
12. LINE\_PREFIX\_BYTES
13. LINE\_SUFFIX\_BYTES
14. MISSING\_CONSTANT
15. OFFSET
16. SAMPLE\_BIT\_MASK
17. SAMPLING\_FACTOR
18. SCALING\_FACTOR
19. SOURCE\_FILE\_NAME
20. SOURCE\_LINES
21. SOURCE\_LINE\_SAMPLES
22. SOURCE\_SAMPLE\_BITS
23. STRETCHED\_FLAG
24. STRETCH\_MINIMUM
25. STRETCH\_MAXIMUM

### A.20.3 Required Objects

None

### A.20.4 Optional Objects

None

### A.20.5 Example

This is an example of an (attached) IMAGE label for a color digital mosaic image from the Mars Digital Image Map CD-ROMs. It includes a CHECKSUM to support automated volume production and validation, a SCALING\_FACTOR to indicate the relationship between sample values and geophysical parameters and stretch keywords to indicate optimal values for image display.

```

PDS_VERSION_ID          = PDS3

RECORD_TYPE              = FIXED_LENGTH
RECORD_BYTES             = 956
FILE_RECORDS             = 965
LABEL_RECORDS           = 3

```

```

^IMAGE_HISTOGRAM      = 4
^IMAGE                = 6

DATA_SET_ID          = "VO1/VO2-M-VIS-5-DIM-V1.0"
PRODUCT_ID           = "MG15N022-GRN-666A"
SPACECRAFT_NAME      = VIKING_ORBITER_1
TARGET_NAME          = MARS
IMAGE_TIME           = 1978-01-14T02:00:00
START_TIME           = UNK
STOP_TIME            = UNK
SPACECRAFT_CLOCK_START_COUNT = UNK
SPACECRAFT_CLOCK_STOP_COUNT = UNK
PRODUCT_CREATION_TIME = 1995-01-01T00:00:00
ORBIT_NUMBER         = 666
FILTER_NAME          = GREEN
IMAGE_ID             = "MG15N022-GRN-666A"
INSTRUMENT_NAME      = {VISUAL_IMAGING_SUBSYSTEM_CAMERA_A,
                        VISUAL_IMAGING_SUBSYSTEM_CAMERA_B}
NOTE                 = "MARS MULTI-SPECTRAL MDIM SERIES"
SOURCE_PRODUCT_ID    = "666A36"
EMISSION_ANGLE       = 21.794
INCIDENCE_ANGLE      = 66.443
PHASE_ANGLE          = 46.111

/* DESCRIPTION OF OBJECTS CONTAINED IN FILE */

OBJECT               = IMAGE_HISTOGRAM
  ITEMS              = 256
  DATA_TYPE         = VAX_INTEGER
  ITEM_BYTES         = 4
END_OBJECT          = IMAGE_HISTOGRAM

OBJECT               = IMAGE
  LINES              = 960
  LINE_SAMPLES       = 956
  SAMPLE_TYPE        = UNSIGNED_INTEGER
  SAMPLE_BITS        = 8
  SAMPLE_BIT_MASK    = 2#11111111#
  CHECKSUM           = 65718982
  SCALING_FACTOR     = 0.001000
                    /* I/F = scaling factor*DN+offset, */
                    /* convert to intensity/flux.      */
  OFFSET             = 0.0
  STRETCHED_FLAG     = FALSE
                    /* Optimum color stretch for display */
                    /* of color images.                  */
  STRETCH_MINIMUM    = ( 53, 0)
  STRETCH_MAXIMUM    = (133,255)
END_OBJECT          = IMAGE

END

```

## A.21 INDEX\_TABLE

The INDEX\_TABLE object is a specific type of a TABLE object that provides information about the data stored on an archive volume. The INDEX\_TABLE contains one row for each data file (or data product label file, in the case where detached labels are used) on the volume. The table is formatted so that it may be read directly by many data management systems on various host computers: all fields (columns) are separated by commas; character fields are enclosed in double quotation marks; and each record ends in a carriage return/line feed sequence.

The columns of an INDEX\_TABLE contain path information for each file, plus values extracted from keywords in the PDS labels. Columns are selected to allow users to a) search the table for specific files of interest; and b) identify the exact location of the file both on the volume and in the PDS catalog. In general, the columns listed in Section A.20.5.1 as *optional* are used for searching the table; the *required* columns listed in Section A.20.4.1 provide the identification information for each file. Where possible the PDS keyword name should be used as the NAME value in the corresponding COLUMN definition.

**Note:** See Section 17.2 for information about the use of the constants “N/A”, “UNK” and “NULL” in an INDEX\_TABLE.

### A.21.1 INDEX\_TABLEs Under Previous Version of the Standards

Prior to version 3.2 of the Standards, the INDEX\_TYPE keyword was optional. Cumulative indices were identified by their filenames, which were (and still are) of the form “CUMINDEX.TAB” or “*axx*CMIDX.TAB” (with *axx* representing up to three alphanumeric characters). So, when INDEX\_TYPE is not present, it defaults to “CUMULATIVE” in cumulative index files (that is, file with filenames as above) and “SINGLE” in all other index files.

### A.21.2 Required Keywords

1. INTERCHANGE\_FORMAT
2. ROWS
3. COLUMNS
4. ROW\_BYTES
5. INDEX\_TYPE

### A.21.3 Optional Keywords

1. NAME
2. DESCRIPTION

3. INDEXED\_FILE\_NAME
4. UNKNOWN\_CONSTANT
5. NOT\_APPLICABLE\_CONSTANT

### A.21.4 Required Objects

1. COLUMN

#### A.21.4.1 Required COLUMN Objects

The following COLUMN objects (as identified by the COLUMN\_NAME keyword) are required to be included in the INDEX\_TABLE object:

##### COLUMN\_NAME

---

1. FILE\_SPECIFICATION\_NAME, or PATH\_NAME and FILE\_NAME
2. PRODUCT\_ID \*\*
3. VOLUME\_ID \*
4. DATA\_SET\_ID \*
5. PRODUCT\_CREATION\_TIME \*
6. LOGICAL\_VOLUME\_PATH\_NAME \* (must be used with PATH\_NAME and FILE\_NAME for a logical volume)

\* If the value is constant across the data in the index table, this keyword can appear in the index table's label. If the value is not constant, then a column of the given name must be used.

\*\* PRODUCT\_ID is not required if it has the same value as FILE\_NAME or FILE\_SPECIFICATION\_NAME.

#### A.21.4.2 Required Keywords (for Required COLUMN Objects)

1. NAME
2. DATA\_TYPE
3. START\_BYTE
4. BYTES
5. DESCRIPTION

### A.21.5 Optional Objects

None

### A.21.5.1 Optional COLUMN Objects (NAME=)

The following COLUMN objects (as identified by the COLUMN\_NAME keyword) may be optionally included in the INDEX\_TABLE object:

#### COLUMN\_NAME

---

1. MISSION\_NAME
2. INSTRUMENT\_NAME (or ID)
3. INSTRUMENT\_HOST\_NAME (or ID), or SPACECRAFT\_NAME (or ID)
4. TARGET\_NAME
5. PRODUCT\_TYPE
6. MISSION\_PHASE\_NAME
7. VOLUME\_SET\_ID
8. START\_TIME
9. STOP\_TIME
10. SPACECRAFT\_CLOCK\_START\_COUNT
11. SPACECRAFT\_CLOCK\_STOP\_COUNT
12. any other search columns

### A.21.6 Example

```

PDS_VERSION_ID          = PDS3

RECORD_TYPE             = FIXED_LENGTH
RECORD_BYTES            = 180
FILE_RECORDS            = 220
DESCRIPTION              = "INDEX.TAB lists all data files on this
                           volume"
^INDEX_TABLE            = "INDEX.TAB"

OBJECT                  = INDEX_TABLE
  INTERCHANGE_FORMAT    = ASCII
  ROW_BYTES             = 180
  ROWS                  = 220
  COLUMNS              = 9
  INDEX_TYPE            = SINGLE
  INDEXED_FILE_NAME    = {"*.AMD", "*.ION", "*.TIM", "*.TRO",
                          "*.WEA", "*.LIT", "*.MIF", "*.MPD",
                          "*.ODF", "*.ODR", "*.ODS", "*.SFO",
                          "*.SOE", "*.TDF"}

OBJECT                  = COLUMN
  NAME                  = VOLUME_ID
  DESCRIPTION           = "Identifies the volume containing the
                           named file"
  DATA_TYPE            = CHARACTER
  START_BYTE           = 2
  BYTES                 = 9

```

```

END_OBJECT          = COLUMN

OBJECT              = COLUMN
  NAME              = DATA_SET_ID
  DESCRIPTION       = "The data set identifier. Acceptable
                    values include 'MO-M-RSS-1-OIDR-V1.0'"
  DATA_TYPE        = CHARACTER
  START_BYTE        = 14
  BYTES             = 25
END_OBJECT          = COLUMN

OBJECT              = COLUMN
  NAME              = PATH_NAME
  DESCRIPTION       = "Path to directory containing file.
                    Acceptable values include:
                    'AMD',
                    'ION',
                    'TIM',
                    'TRO',
                    'WEA',
                    'LIT',
                    'MIF',
                    'MPD',
                    'ODF',
                    'ODR',
                    'ODS',
                    'SFO',
                    'SOE', and
                    'TDF'."
  DATA_TYPE        = CHARACTER
  START_BYTE        = 42
  BYTES             = 9
END_OBJECT          = COLUMN

OBJECT              = COLUMN
  NAME              = FILE_NAME
  DESCRIPTION       = "Name of file in archive"
  DATA_TYPE        = CHARACTER
  START_BYTE        = 54
  BYTES             = 12
END_OBJECT          = COLUMN

OBJECT              = COLUMN
  NAME              = PRODUCT_ID
  DESCRIPTION       = "Original file name on MO PDB or SOPC"
  DATA_TYPE        = CHARACTER
  START_BYTE        = 69
  BYTES             = 33
END_OBJECT          = COLUMN

OBJECT              = COLUMN
  NAME              = START_TIME
  DESCRIPTION       = "Time at which data in the file begin
                    given in the format 'YYYY-MM-DDThh:mm:ss'."

```

```

    DATA_TYPE           = CHARACTER
    START_BYTE           = 105
    BYTES                 = 19
END_OBJECT              = COLUMN

OBJECT                  = COLUMN
  NAME                   = STOP_TIME
  DESCRIPTION             = "Time at which data in the file end
given in the format 'YYYY-MM-DDThh:mm:ss'."
  DATA_TYPE             = CHARACTER
  START_BYTE             = 127
  BYTES                   = 19
END_OBJECT              = COLUMN

OBJECT                  = COLUMN
  NAME                   = PRODUCT_CREATION_TIME
  DESCRIPTION             = "Date and time that file was created."
  DATA_TYPE             = CHARACTER
  START_BYTE             = 149
  BYTES                   = 19
END_OBJECT              = COLUMN

OBJECT                  = COLUMN
  NAME                   = FILE_SIZE
  DESCRIPTION             = "Number of bytes in file, not including
label."
  DATA_TYPE             = "ASCII INTEGER"
  START_BYTE             = 170
  BYTES                   = 9
END_OBJECT              = COLUMN

END_OBJECT              = INDEX_TABLE
END

```



## A.22 PALETTE

The PALETTE object, a sub-class of the TABLE object, contains entries which represent color table assignments for values (i.e., SAMPLEs) contained in an IMAGE.

If the PALETTE is stored in a separate file from the IMAGE object, then it should be stored in ASCII format as 256 rows, each with 4 columns. The first column contains the SAMPLE value (running from 0–255 for an 8-bit SAMPLE, for example), and the remaining three columns contain the relative amount (a value from 0 to 255) of each primary color to be assigned for that SAMPLE value.

If the PALETTE is stored in the same file as the IMAGE object, then the PALETTE should be stored in BINARY format as 256 consecutive 8-bit values for each primary color (RED, GREEN, BLUE) resulting in a 768-byte record.

### A.22.1 Required Keywords

1. INTERCHANGE\_FORMAT
2. ROWS
3. ROW\_BYTES
4. COLUMNS

### A.22.2 Optional Keywords

1. DESCRIPTION
2. NAME

### A.22.3 Required Objects

1. COLUMN

### A.22.4 Optional Objects

None

### A.22.5 Example

The examples below illustrate both types of PALETTE objects (ASCII and BINARY). The first example is a complete label for an ASCII PALETTE object:

```

PDS_VERSION_ID          = PDS3
RECORD_TYPE             = FIXED_LENGTH
RECORD_BYTES           = 80
FILE_RECORDS           = 256
^PALETTE               = "PALETTE.TAB"

/* Image Palette description */
SPACECRAFT_NAME        = MAGELLAN
MISSION_PHASE_NAME     = PRIMARY_MISSION
TARGET_NAME            = VENUS
PRODUCT_ID             = "GEDR-MERC.1;2"
IMAGE_ID               = "GEDR-MERC.1;2"
INSTRUMENT_NAME        = "RADAR SYSTEM"
PRODUCT_CREATION_TIME  = 1995-01-01T00:00:00
NOTE                   = "Palette for browse image"

/* Description of an ASCII PALETTE object */

OBJECT                  = PALETTE
  INTERCHANGE_FORMAT    = ASCII
  ROWS                  = 256
  ROW_BYTES            = 80
  COLUMNS              = 4

  OBJECT                = COLUMN
    NAME                 = SAMPLE
    DESCRIPTION          = "DN value for red, green, blue
                          intensities"
    DATA_TYPE           = ASCII_INTEGER
    START_BYTE          = 1
    BYTES                = 3
  END_OBJECT

  OBJECT                = COLUMN
    NAME                 = RED
    DESCRIPTION          = "Red intensity (0 - 255)"
    DATA_TYPE           = ASCII_INTEGER
    START_BYTE          = 6
    BYTES                = 3
  END_OBJECT

  OBJECT                = COLUMN
    NAME                 = GREEN
    DESCRIPTION          = "Green intensity (0 - 255)"
    DATA_TYPE           = ASCII_INTEGER
    START_BYTE          = 11
    BYTES                = 3
  END_OBJECT

  OBJECT                = COLUMN
    NAME                 = BLUE
    DESCRIPTION          = "Blue intensity (0 - 255)"
    DATA_TYPE           = ASCII_INTEGER
    START_BYTE          = 16

```

```

        BYTES                = 3
    END_OBJECT
END_OBJECT
END

```

This label fragment illustrates the definition of a binary PALETTE object:

```

/* Description of a BINARY PALETTE object */

OBJECT                = PALETTE
  INTERCHANGE_FORMAT = BINARY
  ROWS                = 1
  ROW_BYTES           = 768
  COLUMNS            = 3

OBJECT                = COLUMN
  NAME                = RED
  DATA_TYPE          = UNSIGNED_INTEGER
  START_BYTE          = 1
  ITEMS               = 256
  ITEM_BYTES          = 1
END_OBJECT            = COLUMN

OBJECT                = COLUMN
  NAME                = GREEN
  DATA_TYPE          = UNSIGNED_INTEGER
  START_BYTE          = 257
  ITEMS               = 256
  ITEM_BYTES          = 1
END_OBJECT            = COLUMN

OBJECT                = COLUMN
  NAME                = BLUE
  DATA_TYPE          = UNSIGNED_INTEGER
  START_BYTE          = 513
  ITEMS               = 256
  ITEM_BYTES          = 1
END_OBJECT            = COLUMN
END_OBJECT            = PALETTE

```

## A.23 QUBE

A generalized QUBE object is a multidimensional array (called the core) of sample values in multiple dimensions. The core is homogeneous, and consists of unsigned byte, signed halfword or floating point fullword elements. QUBEs of one to three dimensions may have optional suffix areas in each axis. The suffix areas may be heterogeneous, with elements of different types, but each suffix pixel is always allocated a full word. Special values may be defined for the core and the suffix areas to designate missing values and several kinds of invalid values, such as instrument and representation saturation.

The QUBE is the principal data structure of the ISIS (Integrated Software for Imaging Spectrometers) system. A frequently used specialization of the QUBE object is the ISIS Standard Qube, which is a three-dimensional QUBE with two spatial dimensions and one spectral dimension. Its axes have the interpretations 'sample', 'line' and 'band'. Three physical storage orders are allowed: band-sequential, line\_interleaved (band-interleaved-by-line) and sample\_interleaved (band-interleaved-by-pixel).

An example of a Standard ISIS Qube is a spectral image qube containing data from an imaging spectrometer. Such a qube is simultaneously a set of images (at different wavelengths) of the same target area, and a set of spectra at each point of the target area. Typically, suffix areas in such a qube are confined to 'backplanes' containing geometric or quality information about individual spectra, i.e. about the set of corresponding values at the same pixel location in each band.

The following diagram illustrates the general structure of a Standard ISIS Qube. Note that this is a conceptual or "logical" view of the qube.

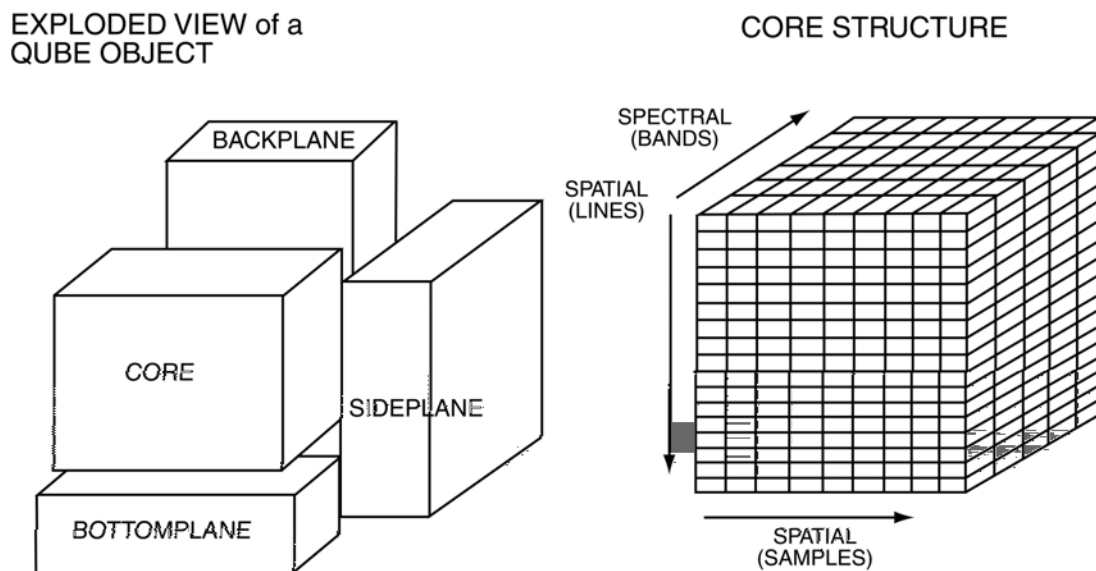

*Figure A.3 – Exploded View of a Qube Object*

Some special requirements are imposed by the ISIS system. A QUBE object must be associated with a HISTORY object. (Other objects, such as HISTOGRAMs, IMAGEs, PALETTEs and TABLEs which contain statistics, display parameters, engineering values or other ancillary data, are optional.) A special element, FILE\_STATE, is required in the implicit FILE object. Some label information is organized into GROUPs, such as BAND\_BIN and IMAGE\_MAP\_PROJECTION. The BAND\_BIN group contains essential wavelength information, and is required for Standard ISIS Qubes.

The ISIS system includes routines for reading and writing files containing QUBE objects. Both 'logical' access, independent of actual storage order, and direct 'physical' access are provided for Standard ISIS Qubes. Only physical access is provided for generalized QUBEs. Most ISIS application programs operate on Standard ISIS Qubes. Arbitrary subqubes ('virtual' qubes) of existing qubes may be specified for most of these programs. In addition, ISIS includes software for handling Tables (an ISIS variant of the PDS Table object) and Instrument Spectral Libraries.

For a complete description, refer to the most recent version of "ISD: ISIS System Design, Build 2", obtainable from the PDS Operator.

NOTE: The following required and optional elements of the QUBE object are ISIS-specific. Since the ISIS system was designed before the current version of the Planetary Science Data Dictionary, some of the element names conflict with current PDS nomenclature standards.

### A.23.1 Required Keywords (Generalized Qube and Standard ISIS Qube)

AXES	Number of axes or dimensions of qube [integer]
AXIS_NAME	Names of axes [sequence of 1-6 literals] (BAND, LINE, SAMPLE) for Standard Qube
CORE_ITEMS	Core dimensions of axes [seq of 1-6 integers]
CORE_ITEM_BYTES	Core element size [integer bytes: {1, 2, 4}]
CORE_ITEM_TYPE	Core element type [literal: {UNSIGNED_INTEGER, INTEGER, REAL}]
CORE_BASE	Base value of core item scaling [real]
CORE_MULTIPLIER	Multiplier for core item scaling [real] 'true' value = base + multiplier * 'stored' value (base = 0.0 and multiplier = 1.0 for REALs)
SUFFIX_BYTES	Storage allocation of suffix elements [integer: always 4]
SUFFIX_ITEMS	Suffix dimensions of axes [seq of 1-6 integers]

CORE_VALID_MINIMUM	Minimum valid core value -- values below this value are reserved for 'special' values, of which 5 are currently assigned [integer or non-decimal integer: these values are fixed by ISIS convention for each allowable item type and size -- see ISD for details]
CORE_NULL	Special value indicating 'invalid' data
CORE_LOW_INSTR_SATURATION	Special value indicating instrument saturation at the low end
CORE_HIGH_INSTR_SATURATION	Special value indicating instrument saturation at the high end
CORE_LOW_REPR_SATURATION	Special value indicating representation saturation at the low end
CORE_HIGH_REPR_SATURATION	Special value indicating representation saturation at the high end

### **A.23.2 Required Keywords (Standard ISIS Qube) and Optional Keywords (Generalized Qube)**

CORE_NAME	Name of value stored in core of qube [literal, e.g. SPECTRAL_RADIANCE]
CORE_UNIT	Unit of value stored in core of qube [literal]
BAND_BIN_CENTER	Wavelengths of bands in a Standard Qube [sequence of reals]
BAND_BIN_UNIT	Unit of wavelength [literal, e.g. MICROMETER]
BAND_BIN_ORIGINAL_BAND	Original band numbers, referring to a Qube of which the current qube is a subqube. In the original qube, these are sequential integers.[sequence of integers]

### **A.23.3 Optional Keywords (Generalized Qube and Standard ISIS Qube)**

BAND_BIN_WIDTH	Width (at half height) of spectral response of bands [sequence of reals]
BAND_BIN_STANDARD_DEVIATION	Standard deviation of spectrometer values at each band [sequence of reals]
BAND_BIN_DETECTOR	Instrument detector number of band, where relevant [sequence of integers]

BAND\_BIN\_GRATING\_POSITION      Instrument grating position of band, where relevant  
[sequence of integers]

### A.23.3.1      **Required Keywords (for each suffix present in a 1-3 dimensional qube):**

Note: These must be prefixed by the specific AXIS\_NAME. These are SAMPLE, LINE and BAND for Standard ISIS Qubes. Only the commonly used BAND variants are shown:

BAND_SUFFIX_NAME	Names of suffix items [sequence of literals]
BAND_SUFFIX_UNIT	Units of suffix items [sequence of literals]
BAND_SUFFIX_ITEM_BYTES	Suffix item sizes [sequence of integer bytes {1, 2, 4}]
BAND_SUFFIX_ITEM_TYPE	Suffix item types [sequence of literals: {UNSIGNED_INTEGER, INTEGER, REAL, ...}]
BAND_SUFFIX_BASE	Base values of suffix item scaling [sequence of reals] (see corresponding core element)
BAND_SUFFIX_MULTIPLIER	Multipliers for suffix item scaling [sequence of reals] (see corresponding core element)
BAND_SUFFIX_VALID_MINIMUM	Minimum valid suffix values
BAND_SUFFIX_NULL	...and assigned special values
BAND_SUFFIX_LOW_INSTR_SAT	[sequences of integers or reals]
BAND_SUFFIX_HIGH_INSTR_SAT	(see corresponding core
BAND_SUFFIX_LOW_REPR_SAT	element definitions for
BAND_SUFFIX_HIGH_REPR_SAT	details)

### A.23.4      **Example**

The following label describes ISIS QUBE data from the Galileo NIMS experiment. The QUBE contains 17 bands of NIMS fixed-map mode raw data numbers and 9 backplanes of ancillary information. In other modes, NIMS can produce data qubes of 34, 102, 204 and 408 bands.

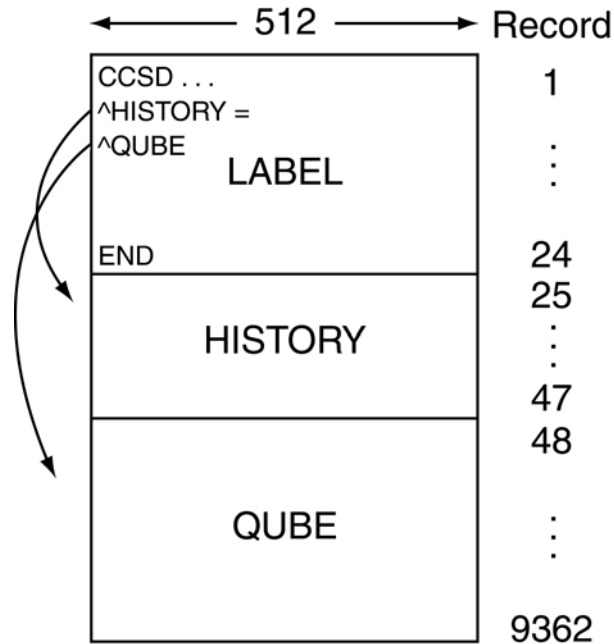

```
PDS_VERSION_ID = PDS3
/* File Structure */
```

```
RECORD_TYPE           = FIXED_LENGTH
RECORD_BYTES          = 512
FILE_RECORDS          = 9158
LABEL_RECORDS         = 24
FILE_STATE            = CLEAN
```

```
^HISTORY              = 25
OBJECT                = HISTORY
END_OBJECT            = HISTORY
```

```
^QUBE                 = 48
OBJECT                = QUBE
```

```
/* Qube structure: Standard ISIS QUBE of NIMS Data */
```

```
AXES                  = 3
AXIS_NAME             = (SAMPLE, LINE, BAND)
```

```
/* Core description */
```

```
CORE_ITEMS           = (229, 291, 17)
CORE_ITEM_BYTES      = 2
CORE_ITEM_TYPE       = VAX_INTEGER
CORE_BASE            = 0.0
CORE_MULTIPLIER      = 1.0
CORE_VALID_MINIMUM   = -32752
CORE_NULL            = -32768
CORE_LOW_REPR_SATUR = -32767
CORE_LOW_INSTR_SATUR = -32766
```



```

CORE_HIGH_INSTR_SATURATION = -32765
CORE_HIGH_REPR_SATURATION = -32764
CORE_NAME                  = RAW_DATA_NUMBER
CORE_UNIT                  = DIMENSIONLESS
PHOTOMETRIC_CORRECTION_TYPE = NONE

/* Suffix description */

SUFFIX_BYTES                = 4
SUFFIX_ITEMS                = (0,0,9)
BAND_SUFFIX_NAME            = (LATITUDE, LONGITUDE, INCIDENCE_ANGLE,
    EMISSION_ANGLE, PHASE_ANGLE, SLANT_DISTANCE, INTERCEPT_ALTITUDE,
    PHASE_ANGLE_STD_DEV, RAW_DATA_NUMBER_STD_DEV)
BAND_SUFFIX_UNIT            = (DEGREE, DEGREE, DEGREE, DEGREE, DEGREE,
    KILOMETER, KILOMETER, DEGREE, DIMENSIONLESS)
BAND_SUFFIX_ITEM_BYTES     = (4,4,4,4,4,4,4,4,4,4)
BAND_SUFFIX_ITEM_TYPE       = (VAX_REAL, VAX_REAL, VAX_REAL, VAX_REAL,
    VAX_REAL, VAX_REAL, VAX_REAL, VAX_REAL, VAX_REAL)
BAND_SUFFIX_BASE           = (0.000000, 0.000000, 0.000000, 0.000000,
    0.000000, 0.000000, 0.000000, 0.000000, 0.000000)
BAND_SUFFIX_MULTIPLIER     = (1.000000, 1.000000, 1.000000, 1.000000,
    1.000000, 1.000000, 1.000000, 1.000000, 1.000000)
BAND_SUFFIX_VALID_MINIMUM  = (16#FFFFFFFF#, 16#FFFFFFFF#,
    16#FFFFFFFF#, 16#FFFFFFFF#, 16#FFFFFFFF#, 16#FFFFFFFF#,
    16#FFFFFFFF#, 16#FFFFFFFF#, 16#FFFFFFFF#)
BAND_SUFFIX_NULL           = (16#FFFFFFFF#, 16#FFFFFFFF#,
    16#FFFFFFFF#, 16#FFFFFFFF#, 16#FFFFFFFF#, 16#FFFFFFFF#,
    16#FFFFFFFF#, 16#FFFFFFFF#, 16#FFFFFFFF#)
BAND_SUFFIX_LOW_REPR_SAT   = (16#FFFFFFFF#, 16#FFFFFFFF#,
    16#FFFFFFFF#, 16#FFFFFFFF#, 16#FFFFFFFF#, 16#FFFFFFFF#,
    16#FFFFFFFF#, 16#FFFFFFFF#, 16#FFFFFFFF#)
BAND_SUFFIX_LOW_INSTR_SAT  = (16#FFFDFFFF#, 16#FFFDFFFF#,
    16#FFFDFFFF#, 16#FFFDFFFF#, 16#FFFDFFFF#, 16#FFFDFFFF#,
    16#FFFDFFFF#, 16#FFFDFFFF#, 16#FFFDFFFF#)
BAND_SUFFIX_HIGH_INSTR_SAT = (16#FFFCFFFF#, 16#FFFCFFFF#,
    16#FFFCFFFF#, 16#FFFCFFFF#, 16#FFFCFFFF#, 16#FFFCFFFF#,
    16#FFFCFFFF#, 16#FFFCFFFF#, 16#FFFCFFFF#)
BAND_SUFFIX_HIGH_REPR_SAT  = (16#FFFBFFFF#, 16#FFFBFFFF#,
    16#FFFBFFFF#, 16#FFFBFFFF#, 16#FFFBFFFF#, 16#FFFBFFFF#,
    16#FFFBFFFF#, 16#FFFBFFFF#, 16#FFFBFFFF#)
BAND_SUFFIX_NOTE           = "The backplanes contain 7 geometric
    parameters, the standard deviation of one of them, the standard
    deviation of a selected data band, and 0 to 10 'spectral index'
    bands, each a user-specified function of the data bands. (See
    the BAND_SUFFIX_NAME values.)

```

Longitude ranges from 0 to 360 degrees, with positive direction specified by POSITIVE\_LONGITUDE\_DIRECTION in the IMAGE\_MAP\_PROJECTION group.

INTERCEPT\_ALTITUDE contains values for the DIFFERENCE between the length of the normal from the center of the target body to the line of sight AND the radius of the target body. On-target points have zero values. Points beyond the maximum expanded radius have

null values. This plane thus also serves as a set of 'off-limb' flags. It is meaningful only for the ORTHOGRAPHIC and POINT\_PERSPECTIVE projections; otherwise all values are zero. The geometric standard deviation backplane contains the standard deviation of the geometry backplane indicated in its NAME, except that the special value 16#FFF9FFFF# replaces the standard deviation where the corresponding core pixels have been 'filled'.

The data band standard deviation plane is computed for the NIMS data band specified by STD\_DEV\_SELECTED\_BAND\_NUMBER. This may be either a raw data number, or spectral radiance, whichever is indicated by CORE\_NAME.

The (optional) spectral index bands were generated by the Vicar F2 program. The corresponding BAND\_SUFFIX\_NAME is an abbreviated formula for the function used, where Bn should be read 'NIMS data band n'. For example: B4/B8 represents the ratio of bands 4 and 8."

```

STD_DEV_SELECTED_BAND_NUMBER = 9

/* Data description: general */

DATA_SET_ID           = "GO-V-NIMS-4-MOSAIC-V1.0"
PRODUCT_ID            = "XYZ"
SPACECRAFT_NAME       = GALILEO_ORBITER
MISSION_PHASE_NAME    = VENUS_ENCOUNTER
INSTRUMENT_NAME       = NEAR_INFRARED_MAPPING_SPECTROMETER
INSTRUMENT_ID         = NIMS
^INSTRUMENT_DESCRIPTION = "NIMSINST.TXT"

TARGET_NAME           = VENUS
START_TIME            = 1990-02-10T01:49:58
STOP_TIME             = 1990-02-10T02:31:52
NATIVE_START_TIME     = 180425.85
NATIVE_STOP_TIME      = 180467.34
OBSERVATION_NAME      = 'VPDIN1'
OBSERVATION_NOTE      = "VPDIN1 / Footprint, Limbfit,
                        Height=50"

INCIDENCE_ANGLE       = 160.48
EMISSION_ANGLE        = 14.01
PHASE_ANGLE           = 147.39
SUB_SOLAR_AZIMUTH     = -174.74
SUB_SPACECRAFT_AZIMUTH = -0.80
MINIMUM_SLANT_DISTANCE = 85684.10
MAXIMUM_SLANT_DISTANCE = 103175.00
MIN_SPACECRAFT_SOLAR_DISTANCE = 1.076102e+08
MAX_SPACECRAFT_SOLAR_DISTANCE = 1.076250e+08

/* Data description: instrument status */

INSTRUMENT_MODE_ID    = FIXED_MAP
GAIN_MODE_ID          = 2

```

```

CHOPPER_MODE_ID           = REFERENCE
START_GRATING_POSITION    = 16
OFFSET_GRATING_POSITION   = 04

MEAN_FOCAL_PLANE_TEMPERATURE = 85.569702
MEAN_RAD_SHIELD_TEMPERATURE = 123.636002
MEAN_TELESCOPE_TEMPERATURE = 139.604996
MEAN_GRATING_TEMPERATURE   = 142.580002
MEAN_CHOPPER_TEMPERATURE   = 142.449997
MEAN_ELECTRONICS_TEMPERATURE = 287.049988

GROUP                      = BAND_BIN

  BAND_BIN_CENTER          = (0.798777, 0.937873, 1.179840,
    1.458040, 1.736630, 2.017250, 2.298800, 2.579060, 2.864540,
    3.144230, 3.427810, 3.710640, 3.993880, 4.277290, 4.561400,
    4.843560, 5.126080)
  BAND_BIN_UNIT            = MICROMETER
  BAND_BIN_ORIGINAL_BAND   = (1, 2, 3, 4, 5, 6, 7, 8, 9, 10, 11,
    12, 13, 14, 15, 16, 17)
  BAND_BIN_GRATING_POSITION = (16, 16, 16, 16, 16, 16, 16, 16, 16, 16,
    16, 16, 16, 16, 16, 16)
  BAND_BIN_DETECTOR        = (1, 2, 3, 4, 5, 6, 7, 8, 9, 10, 11,
    12, 13, 14, 15, 16, 17)
END_GROUP                  = BAND_BIN

GROUP                      = IMAGE_MAP_PROJECTION
  /* Projection description */
  MAP_PROJECTION_TYPE      = OBLIQUE_ORTHOGRAPHIC
  MAP_SCALE                 = 45.000
  MAP_RESOLUTION           = 2.366
  CENTER_LATITUDE          = 12.00
  CENTER_LONGITUDE         = 350.00
  LINE_PROJECTION_OFFSET   = 149.10
  SAMPLE_PROJECTION_OFFSET = 85.10
  MINIMUM_LATITUDE         = 11.71
  MAXIMUM_LATITUDE         = 13.62
  MINIMUM_LONGITUDE        = 349.62
  MAXIMUM_LONGITUDE        = 351.72
  POSITIVE_LONGITUDE_DIRECTION = EAST
  A_AXIS_RADIUS            = 6101.000000
  B_AXIS_RADIUS            = 6101.000000
  C_AXIS_RADIUS            = 6101.000000
  REFERENCE_LATITUDE       = 0.000000
  REFERENCE_LONGITUDE      = 0.000000
  MAP_PROJECTION_ROTATION  = 0.00
  LINE_FIRST_PIXEL         = 1
  LINE_LAST_PIXEL          = 229
  SAMPLE_FIRST_PIXEL       = 1
  SAMPLE_LAST_PIXEL        = 291
END_GROUP                  = IMAGE_MAP_PROJECTION

END_OBJECT                 = QUBE
END

```

## A.24 SERIES

The SERIES object is a sub-class of the TABLE object. It is used for storing a sequence of measurements organized in a specific way (e.g., chronologically, by radial distance, etc.). The SERIES uses the same physical format specification as the TABLE object with additional sampling parameter information describing the variation between elements in the series. The sampling parameter keywords are required for the SERIES object itself, but are optional for the COLUMN sub-objects, depending on the data organization.

The sampling parameter keywords in the SERIES object represent the variation between the ROWS of data. For data with regularly-spaced rows, the SAMPLING\_PARAMETER\_INTERVAL keyword defines the row-to-row variation. For data in which rows are irregularly spaced, the SAMPLING\_PARAMETER\_INTERVAL keyword is “N/A” and the actual sampling parameter is included as a COLUMN in the SERIES.

When the data vary regularly across items of a single column, sampling parameter keywords appear as part of the COLUMN sub-object. Data sampled at irregular intervals described as separate columns may also provide sampling parameter information specific to each column.

Optional MINIMUM\_SAMPLING\_PARAMETER and MAXIMUM\_SAMPLING\_PARAMETER keywords should be added whenever possible to indicate the range in which the data were sampled. For data sampled at a single point rather than over a range, both the MINIMUM\_SAMPLING\_PARAMETER and MAXIMUM\_SAMPLING\_PARAMETER are set to the specific value.

The object name “TIME\_SERIES” is used when the series is chronological. In this case the label keywords START\_TIME and STOP\_TIME are assumed to indicate the minimum and maximum times in the file. If this is not the case, the MINIMUM\_SAMPLING\_PARAMETER and MAXIMUM\_SAMPLING\_PARAMETER keywords should be used to specify the corresponding time values for the series.

### A.24.1 Required Keywords

1. INTERCHANGE\_FORMAT
2. ROWS
3. COLUMNS
4. ROW\_BYTES
5. SAMPLING\_PARAMETER\_NAME
6. SAMPLING\_PARAMETER\_UNIT
7. SAMPLING\_PARAMETER\_INTERVAL

### **A.24.2 Optional Keywords**

1. NAME
2. ROW\_PREFIX\_BYTES
3. ROW\_SUFFIX\_BYTES
4. MINIMUM\_SAMPLING\_PARAMETER
5. MAXIMUM\_SAMPLING\_PARAMETER
6. DERIVED\_MINIMUM
7. DERIVED\_MAXIMUM
8. DESCRIPTION

### **A.24.3 Required Objects**

1. COLUMN

### **A.24.4 Optional Objects**

1. CONTAINER

### **A.24.5 Example**

This example illustrates the use of the SERIES object for data that vary regularly in two ways: rows of data in the SERIES occur at 60 millisecond intervals, while the column values occur at .03472222 millisecond intervals. Note that, as with other forms of the TABLE object, each row in a SERIES may contain prefix or suffix bytes, indicated in this case by the ROW\_PREFIX\_BYTES in the TIME\_SERIES definition. The structure of the prefix is defined by the ROW\_PREFIX\_TABLE object, for which the COLUMN definitions are stored in a separate file ("ROWPRX.FMT").

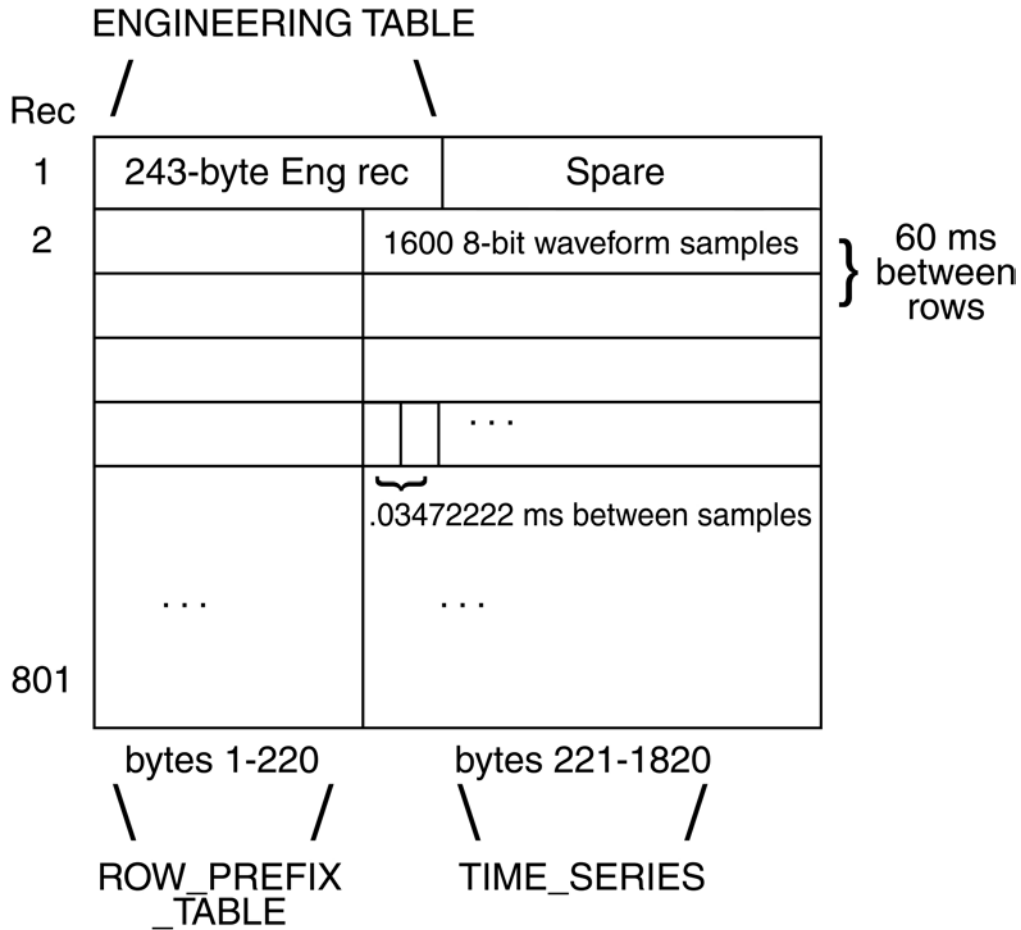

```

PDS_VERSION_ID           = PDS3
RECORD_TYPE              = FIXED_LENGTH
RECORD_BYTES             = 1820
FILE_RECORDS             = 801
^ENGINEERING_TABLE      = ("C0900313.DAT", 1)
^ROW_PREFIX_TABLE       = ("C0900313.DAT", 2)
^TIME_SERIES             = ("C0900313.DAT", 2)

/* Observation description */
DATA_SET_ID              = "VG2-N-PWS-2-EDR-WFRM-60MS-V1.0"
PRODUCT_ID               = "C0900313.DAT"
PRODUCT_CREATION_TIME    = "UNK"
SPACECRAFT_NAME          = VOYAGER_2
SPACECRAFT_CLOCK_START_COUNT = "09003.13.002"
SPACECRAFT_CLOCK_STOP_COUNT = "09003.13.002"
EARTH_RECEIVED_TIME      = 1989-159T13:35:00.121
START_TIME               = 1989-157T14:16:56.979
STOP_TIME                = "N/A"
MISSION_PHASE_NAME       = NEPTUNE_ENCOUNTER
TARGET_NAME              = NEPTUNE
    
```

```

/* Instrument description */
INSTRUMENT_NAME          = PLASMA_WAVE_RECEIVER
INSTRUMENT_ID           = PWS
SECTION_ID              = WFRM

/* Object descriptions */
OBJECT                   = ENGINEERING_TABLE
  INTERCHANGE_FORMAT     = BINARY
  ROWS                   = 1
  COLUMNS               = 106
  ROW_BYTES              = 243
  ROW_SUFFIX_BYTES       = 1577
  DESCRIPTION            = "This table describes the format of
    the engineering record which is included as the first record in
    each PWS high rate waveform file. This record contains the first
    242 bytes of data extracted from the Mission and Test Imaging System
    (MTIS) header record on each file of an imaging EDR tape. A 243rd
    byte containing some flag fields has been added to the table for all
    data collected during the Neptune encounter."
  ^STRUCTURE             = "ENGTAB.FMT"
END_OBJECT               = ENGINEERING_TABLE

OBJECT                   = ROW_PREFIX_TABLE
  INTERCHANGE_FORMAT     = BINARY
  ROWS                   = 800
  COLUMNS               = 47
  ROW_BYTES              = 220
  ROW_SUFFIX_BYTES       = 1600
  DESCRIPTION            = "This table describes the format of
    the engineering data associated with the collection of each row of
    waveform data (1600 waveform samples)."
  ^STRUCTURE             = "ROWPRX.FMT"
END_OBJECT               = ROW_PREFIX_TABLE

OBJECT                   = TIME_SERIES
  NAME                   = WAVEFORM_FRAME
  INTERCHANGE_FORMAT     = BINARY
  ROWS                   = 799
  COLUMNS               = 1
  ROW_BYTES              = 1600
  ROW_PREFIX_BYTES       = 220
  SAMPLING_PARAMETER_NAME = TIME
  SAMPLING_PARAMETER_UNIT = SECOND
  SAMPLING_PARAMETER_INTERVAL = .06 /* 60 MS between rows */
  DESCRIPTION            = "This time_series consists of up to
    800 records (or rows, lines) of PWS waveform sample data. Each
    record 2-801 of the file (or frame) contains 1600 waveform samples,
    prefaced by 220 bytes of MTIS information. The 1600 samples are
    collected in 55.56 msec followed by a 4.44 msec gap. Each 60 msec
    interval constitutes a line of waveform samples. Each file contains
    up to 800 lines of waveform samples for a 48 sec frame."

OBJECT                   = COLUMN
  NAME                   = WAVEFORM_SAMPLES

```

```

DATA_TYPE                = MSB_UNSIGNED_INTEGER
START_BYTE               = 221
BYTES                    = 1600
ITEMS                    = 1600
ITEM_BYTES               = 1
SAMPLING_PARAMETER_NAME = TIME
SAMPLING_PARAMETER_UNIT = SECOND
SAMPLING_PARAMETER_INTERVAL = 0.00003472222 /*time between samples*/

OFFSET                   = -7.5
VALID_MINIMUM           = 0
VALID_MAXIMUM           = 15
DESCRIPTION              = "The 1-byte waveform samples
constitute an array of waveform measurements which are encoded into
binary values from 0 to 15 and may be re-mapped to reduce the
artificial zero-frequency component. For example, stored values can
be mapped to the following floating point values. The original 4-
bit data samples have been repackaged into 8-bit (1 byte) items
without modification for archival purposes.\n

                                0 = -7.5  1 = -6.5  2 = -5.5    3 = -4.5
                                4 = -3.5  5 = -2.5  6 = -1.5    7 = -0.5
                                8 =  0.5  9 =  1.5 10 =  2.5    11 =  3.5
                                12 =  4.5 13 =  5.5 14 =  6.5    15 =  7.5

"
END_OBJECT               = COLUMN
END_OBJECT               = TIME_SERIES

END

```



## A.25 SPECTRUM

The SPECTRUM object is a form of TABLE used for storing spectral measurements. The SPECTRUM object is assumed to have a number of measurements of the observation target taken in different spectral bands. The SPECTRUM object uses the same physical format specification as the TABLE object, but includes sampling parameter definitions which indicate the spectral region measured in successive COLUMNS or ROWS. The common sampling parameters for SPECTRUM objects are wavelength, frequency, or velocity.

A regularly sampled SPECTRUM can be stored either horizontally as a one-row table with a single column containing  $n$  samples (indicated in the COLUMN definition by “ITEMS =  $n$ ”), or vertically as a one-column table with  $n$  rows where each row contains a sample of the spectrum. The vertical format allows additional columns to be defined for related parameters for each sample value (e.g., error bars). These related columns may also be described in a separate PREFIX or SUFFIX table.

In the horizontal format, the sampling parameter specifications are included in the COLUMN definition. For a vertically defined SPECTRUM, the sampling parameter information is provided in the SPECTRUM object, since it is describing the spectral variation between the rows of the data. An irregularly sampled SPECTRUM must be stored horizontally, with each specific spectral range identified as a separate column.

### A.25.1 Required Keywords

1. INTERCHANGE\_FORMAT
2. ROWS
3. COLUMNS
4. ROW\_BYTES

### A.25.2 Optional Keywords

1. NAME
2. SAMPLING\_PARAMETER\_NAME
3. SAMPLING\_PARAMETER\_UNIT
4. SAMPLING\_PARAMETER\_INTERVAL
5. ROW\_PREFIX\_BYTES
6. ROW\_SUFFIX\_BYTES
7. MINIMUM\_SAMPLING\_PARAMETER
8. MAXIMUM\_SAMPLING\_PARAMETER
9. DERIVED\_MINIMUM
10. DERIVED\_MAXIMUM
11. DESCRIPTION

### A.25.3 Required Objects

1. COLUMN

### A.25.4 Optional Objects

1. CONTAINER

### A.25.5 Example

This example illustrates a SPECTRUM data object stored in a vertical format. The data are regularly sampled at intervals of 99.09618 meters/second and data samples are stored in successive ROWS.

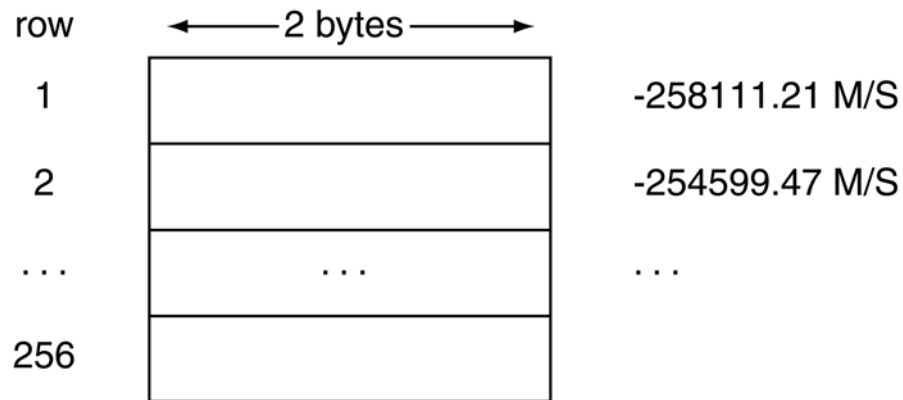

```

PDS_VERSION_ID          = PDS3
RECORD_TYPE              = FIXED_LENGTH
RECORD_BYTES             = 2
FILE_RECORDS             = 256
PRODUCT_ID               = "RSSL007.DAT"
DATA_SET_ID              = "IHW-C-RSSL-3-EDR-HALLEY-V1.0"
TARGET_NAME              = "HALLEY"
INSTRUMENT_HOST_NAME     = "IHW RADIO STUDIES NETWORK"
INSTRUMENT_NAME          = "RADIO SPECTRAL LINE DATA"
OBSERVATION_ID           = "621270"
START_TIME               = 1985-11-10T00:43:12.000
STOP_TIME                 = 1985-11-10T00:43:12.000
PRODUCT_CREATION_TIME    = "UNK"

```

```

/* Record Pointer to Major Object */
^TOTAL_INTENSITY_SPECTRUM = "RSSL0007.DAT"

```

```

/* Object Description */

```

```

OBJECT                   = SPECTRUM
INTERCHANGE_FORMAT       = BINARY

```

```

ROWS = 256
ROW_BYTES = 2
COLUMNS = 1
SAMPLING_PARAMETER_NAME = "VELO_COM"
MINIMUM_SAMPLING_PARAMETER = -1.268431E+04
SAMPLING_PARAMETER_INTERVAL = 9.909618E+01
SAMPLING_PARAMETER_UNIT = "METERS/SECOND"
DESCRIPTION = "Radio Studies; Spectral Line intensity
               spectrum. Spectrum is organized as 1
               column with 256 rows. Each row
               contains a spectral value for the
               velocity derived from the sampling
               parameter information associated with
               each row."

OBJECT = COLUMN
  NAME = FLUX_DENSITY
  DATA_TYPE = MSB_INTEGER
  START_BYTE = 1
  BYTES = 2
  SCALING_FACTOR = 7.251200E-04
  OFFSET = 0.000000E+01
  DERIVED_MINIMUM = 2.380000E+01
  DERIVED_MAXIMUM = 3.490000E+01
END_OBJECT = COLUMN
END_OBJECT = SPECTRUM

END
```

## A.26 SPICE KERNEL

The SPICE\_KERNEL object describes a single kernel file in a collection of SPICE kernels. SPICE kernels provide ancillary data needed to support the planning and subsequent analysis of space science observations. The SPICE system includes the software and documentation required to read the SPICE Kernels and use the data contained therein to help plan observations or interpret space science data. This software and associated documentation are collectively called the NAIF Toolkit.

Kernel files are the major components of the SPICE system. Each type of kernel, indicated by the KERNEL\_TYPE keyword, corresponds to one of these components and has a specific abbreviation. The major kernel types, their abbreviations, and the associated file extension(s) are listed in the following table. (For a complete list of file extensions, see Section 10.2.3.)

<b>KERNEL_TYPE</b>	<b>Abbreviation</b>	<b>File Extension</b>	<b>Contents</b>
EPHEMERIS	SPK	.BSP – <i>binary</i> .XSP – <i>transfer</i>	Spacecraft, planet, satellite, or other target body ephemeris data to provide position and velocity of a target as a function of time
TARGET_CONSTANTS	PCK	.TPC	Cartographic constants for a planet, satellite, comet, or asteroid
INSTRUMENT	IK	.TI	Collected science instrument information, including specification of the mounting alignment, internal timing, and other information needed to interpret measurements made with a particular instrument
POINTING	CK	.BC – <i>binary</i> .XC – <i>transfer</i>	Pointing data, e.g., the inertially referenced attitude for a spacecraft structure upon which instruments are mounted, given as a function of time
EVENTS	EK	.XES	Event information, e.g., spacecraft and instrument commands, ground data system event logs, and experimenter's notebook comments
LEAPSECONDS	LSK	.TLS	An account of the leapseconds needed to correlate civil time (UTC) to ephemeris time (TDB), the measure of time used in the SP kernel files
SPACECRAFT_CLOCK - COEFFICIENTS	SCLK	.TSC	Data needed to correlate a spacecraft clock to ephemeris time

Data products referencing a particular SPICE kernel do so by including the SOURCE\_PRODUCT\_ID keyword in their label with a value corresponding to that of the PRODUCT\_ID keyword in the SPICE\_KERNEL label. (The PRODUCT\_ID keyword is unique to a data product.)

### A.26.1 Required Keywords

1. DESCRIPTION
2. INTERCHANGE\_FORMAT
3. KERNEL\_TYPE

### A.26.2 Optional Keywords

Any

### A.26.3 Required Objects

None

### A.26.4 Optional Objects

None

### A.26.5 Example

Following is an example of a SPICE CK (pointing) kernel label. This label would be attached to the CK file, and thus would be immediately followed by the internal CK file header. (This example was fabricated for use here based on existing examples.)

```

PDS_VERSION_ID          = PDS3
RECORD_TYPE             = STREAM
MISSION_NAME            = MARS_OBSERVER
SPACECRAFT_NAME         = MARS_OBSERVER
DATA_SET_ID             = "MO-M-SPICE-6-CK-V1.0"
FILE_NAME               = "NAF0000D.TC"
PRODUCT_ID              = "NAF0000D-CK"
PRODUCT_CREATION_TIME   = 1992-04-14T12:00:00
PRODUCER_ID             = "NAIF"
MISSION_PHASE_TYPE      = "ORBIT"
PRODUCT_VERSION_TYPE    = "TEST"
START_TIME              = 1994-01-06T00:00:00
STOP_TIME               = 1994-02-04T23:55:00
SPACECRAFT_CLOCK_START_COUNT = "3/76681108.213"
SPACECRAFT_CLOCK_STOP_COUNT = "4/79373491.118"
TARGET_NAME             = MARS
INSTRUMENT_NAME         = "MARS OBSERVER SPACECRAFT"
INSTRUMENT_ID           = MO
SOURCE_PRODUCT_ID       =
    {"NAF0000C.BSP", "NAF0000C.TLS", "NAF0000C.TSC"}
NOTE                    = "BASED ON EPHEMERIS IN NAF0000C.BSP. FOR
    SOFTWARE TESTING ONLY."

```

```
OBJECT = SPICE_KERNEL
INTERCHANGE_FORMAT = ASCII
KERNEL_TYPE = POINTING
DESCRIPTION = "This is a SPICE kernel file, designed
to be accessed using NAIF Toolkit software. Contact your flight
project representative or the NAIF node of the Planetary Data System
if you wish to obtain a copy of the NAIF Toolkit. The Toolkit
consists of portable FORTRAN 77 code and extensive user
documentation."
END_OBJECT = SPICE_KERNEL
END
```

## A.27 SPREADSHEET

The SPREADSHEET is a natural storage format for data products in which the data rows are sparsely populated or field values have variable lengths.

A SPREADSHEET definition describes a collection of logically uniform rows containing ASCII values stored in variable-width fields separated by field delimiters. Each row within a SPREADSHEET has the same number of fields, in the same field order; and each field contains the same logical content. By definition, the SPREADSHEET object is used only to describe ASCII data objects. Therefore, it is not necessary to include the INTERCHANGE\_FORMAT keyword within the object keyword list. The rows and fields of the SPREADSHEET object provide a natural correspondence to the rows and columns of fixed-width tables. Each field is defined by a variable width FIELD object (see section A.14); the value of the FIELDS keyword is the total number of FIELD objects defined in the SPREADSHEET. All SPREADSHEET objects have variable-length records and have rows delimited by carriage-return line-feed (<CR><LF>) ASCII line termination characters.

### A.27.1 Required Keywords

4. ROWS
5. ROW\_BYTES
6. FIELDS
7. FIELD\_DELIMITER

### A.27.2 Optional Keywords

10. NAME
11. DESCRIPTION
12. PSDD

### A.27.3 Required Objects

1. FIELD

### A.27.4 Optional Objects

None

Notes:

1. The RECORD\_BYTES keyword in the implied file object definition of the PDS label containing a SPREADSHEET object definition should specify the actual number of bytes in the longest record within the file being described. If the file contains several components, this longest record may not necessarily be in the SPREADSHEET.
2. The ROW\_BYTES keyword within the SPREADSHEET object definition is used to specify the maximum number of bytes that could be contained in a row in the SPREADSHEET object (i.e. the sum of all the FIELD object BYTES values, plus the number of delimiters and quotation marks, plus the 2 bytes for the <CR><LF> line termination).

### **A.27.5 Required SPREADSHEET Formats**

The SPREADSHEET is an ASCII data object. Its records contain fixed numbers of variable-length fields and are delimited by carriage-return line-feed pairs. The FIELD delimiter can be COMMA, SEMICOLON, TAB, or VERTICAL\_BAR; subfields (if any) are delimited by the same character.

The ASCII format makes the SPREADSHEET readable by both machines and humans. The relative loss in human readability (compared to the TABLE object) is mitigated by more efficient storage, especially for sparsely populated fields.

Several keywords take on special meanings in the SPREADSHEET context. BYTES (and ITEM\_BYTES, if used) gives the maximum allowable number of bytes in the FIELD (ITEM). ROW\_BYTES is the maximum allowable number of bytes in the row, including delimiters, quotation marks, and the carriage-return line-feed pair. RECORD\_TYPE within the implied parent file object is always STREAM. RECORD\_BYTES within the implied file is the actual number of bytes in the longest record, including the carriage-return line-feed pair. If the file contains more than the SPREADSHEET, however, the longest record may not be a SPREADSHEET record.

### **A.27.6 Recommended SPREADSHEET Formats**

The recommended format for SPREADSHEET objects is a comma-separated value format in which string fields are enclosed in double quotes. This format can be imported directly into many commercial data management systems and spreadsheet applications.

The recommended file name extension for files containing SPREADSHEET objects is CSV (e.g., MYDATA.CSV), but the CSV extension does not necessarily imply that the field delimiter is COMMA.

Example - Recommended SPREADSHEET



The following example shows a sparse matrix described as a SPREADSHEET object. The longest record is 85-bytes. Note that delimiters (double quotes and commas) and line terminators (<CR><LF>) are included in the byte count for each record (RECORD\_BYTES) and row (ROW\_BYTES).

Contents of file "MYDATA.CSV":

```
2004-03-04T00:00:00.012,0.45,"MODE 1",0,,,1,,,,-1,12,5,1,2,1,1,0,1,3,1,0<CR><LF>
2004-03-04T00:00:01.012,0.45,"MODE 1",1,,,1,,,6,9,15,8,7,2,1,1,0,0,1,0<CR><LF>
2004-03-04T00:00:02.012,0.45,"MODE 1",2,,,5,,,25,15,10,4,2,1,1,1,1,0,1,1<CR><LF>
2004-03-04T00:00:03.012,0.45,"MODE 1",1,,,1,,,2,4,8,3,1,1,1,1,1,1,0,0<CR><LF>
2004-03-04T00:00:04.012,0.45,"MODE 5",1,1,3,1,1,2,3,1,1,2,2,1,4,3,1,1,4,1,1,0<CR><LF>
2004-03-04T00:00:05.012,0.45,"MODE 5",1,5,4,2,1,1,1,1,2,0,0,1,0,1,1,0,0,0,0<CR><LF>
2004-03-04T00:00:06.012,0.45,"MODE 5",1,6,3,5,4,3,1,,0,1,1,1,1,2,1,1,1,3,1,0<CR><LF>
2004-03-04T00:00:07.012,0.45,"MODE 6",,,,,,3,,,5,1,,1,3,2,3,,,,,<CR><LF>
2004-03-04T00:00:08.012,0.45,"MODE 6",,,,,,1,,,2,,1,,1,4,,1,2,,,,,<CR><LF>
2004-03-04T00:00:09.012,0.45,"MODE 6",,,,,,1,,,,,1,1,1,,1,,,,,<CR><LF>
2004-03-04T00:00:10.017,4.00,"MODE 11",,,,,,8,15,14,21,24,18,15,10,8,9,11,6,-1,9,8,6<CR><LF>
2004-03-04T00:00:15.017,4.00,"MODE 11",,,,,,8,12,17,35,20,12,5,1,2,1,1,8,11,7,8,6<CR><LF>
2004-03-04T00:00:20.017,4.00,"MODE 11",,,,,,4,8,12,32,24,12,15,4,3,1,1,6,7,3,5,2<CR><LF>
2004-03-04T00:00:25.017,4.00,"MODE 13",,,,,,1,5,12,12,14,12,5,1,1,7,2,4,,,,,<CR><LF>
2004-03-04T00:00:30.017,4.00,"MODE 13",,,,,,1,5,5,14,16,10,8,3,1,5,3,2,,,,,<CR><LF>
2004-03-04T00:00:35.017,4.00,"MODE 13",,,,,,1,2,3,2,19,43,21,17,4,8,3,1,,,,,<CR><LF>
2004-03-04T00:00:40.017,4.00,"MODE 13",,,,,,1,2,1,2,4,12,9,3,1,1,1,1,,,,,<CR><LF>
2004-03-04T00:00:45.017,4.00,"MODE 13",,,,,,1,3,1,-1,9,16,7,1,1,1,1,2,,,,,<CR><LF>
2004-03-04T00:00:50.017,4.00,"MODE 13",,,,,,1,2,1,2,4,12,5,1,1,1,1,1,,,,,<CR><LF>
2004-03-04T00:00:55.017,4.00,"MODE 13",,,,,,1,2,1,2,4,10,5,1,1,1,1,1,,,,,<CR><LF>
```

MYDATA.CSV is an example data file described by a SPREADSHEET object definition within a PDS label. The longest record in this file is 85 bytes (record 11) and this value is assigned to the RECORD\_BYTES keyword. However, records described by this SPREADSHEET definition could be as long as 163 bytes (see example label below). The value assigned to the ROW\_BYTES keyword (163) is the maximum possible row size (bytes) described by the SPREADSHEET object definition.

Bytes	Field
23	- Time (23)
8	- delimiter + duration (7)
10	- delimiter + quotes(2) + mode string (7)
60	- delimiter + electrons (59)
60	- delimiter + ions (59)
+ 2	- CR + LF
-----	
= 163	= ROW_BYTES

Contents of file "MYDATA.LBL":

```
PDS_VERSION_ID          = PDS3
RECORD_TYPE             = STREAM
RECORD_BYTES            = 85      /* Largest actual record in the file */
FILE_RECORDS            = 20
^SPREADSHEET            = "MYDATA.CSV"
DATA_SET_ID             = "CO-S-INST-2-DUMMY-DATA-V1.0"
SPACECRAFT_NAME         = "CASSINI ORBITER"
INSTRUMENT_NAME         = "MY INSTRUMENT"
TARGET_NAME              = {"SATURN", "SOLAR_WIND"}
PRODUCT_ID              = "MYDATA.CSV"
PRODUCT_CREATION_TIME   = 2004-08-04T11:15:00
START_TIME              = 2004-03-04T00:00:00.012
STOP_TIME               = 2004-03-04T00:00:55.017
```

```

DESCRIPTION          = "This file contains an example
                        sparse matrix data object (SPREADSHEET)."
```

```

OBJECT              = SPREADSHEET
  ROWS              = 20
  ROW_BYTES        = 163      /* Size of longest possible row*/
  FIELDS           = 5
  FIELD_DELIMITER  = "COMMA"
```

```

  OBJECT           = FIELD
    NAME           = "TIME"
    DATA_TYPE     = TIME
    FIELD_NUMBER   = 1
    BYTES         = 23
    DESCRIPTION    = "Spacecraft event time (UT) for this data record."
  END_OBJECT      = FIELD
```

```

  OBJECT           = FIELD
    NAME           = "DURATION"
    FIELD_NUMBER   = 2
    BYTES         = 7
    FORMAT        = "F7.2"
    DATA_TYPE    = "ASCII_REAL"
    UNITS         = "SECOND"
    DESCRIPTION    = "Time interval over which counting was performed
(second)."
```

```

  END_OBJECT      = FIELD
```

```

  OBJECT           = FIELD
    NAME           = "MODE"
    FIELD_NUMBER   = 3
    BYTES         = 7 /* doesn't count bytes occupied by double quotes*/
    FORMAT        = "A7"
    DATA_TYPE    = "CHARACTER"
    DESCRIPTION    = "Scan mode name. See the instrument description for
a complete list of scan mode names and properties."
  END_OBJECT      = FIELD
```

```

  OBJECT           = FIELD
    NAME           = "ELECTRON COUNTS"
    FIELD_NUMBER   = 4
    BYTES         = 59 /* Maximum bytes including item delimiters */
    ITEMS         = 10
    ITEM_BYTES    = 5 /* Maximum item bytes */
    FORMAT        = "I5"
    DATA_TYPE    = "ASCII_INTEGER"
    UNITS         = "COUNTS"
    MISSING_CONSTANT = -1
    DESCRIPTION    = "This field contains electron counts from channels
E1-E10. Items without values indicate channels not
counted during the interval. Values of zero denote
counted channels in which no electrons were
detected. Values of -1 denote corrupted data,
excluded from the data file (counted, but value
undefined)."
```

```

  END_OBJECT      = FIELD
```

```

  OBJECT           = FIELD
    NAME           = "ION COUNTS"
    FIELD_NUMBER   = 5 /* 5th FIELD object in label */
    BYTES         = 59
    ITEMS         = 10
    ITEM_BYTES    = 5
    FORMAT        = "I5"
```

```
DATA_TYPE      = "ASCII_INTEGER"
UNITS          = "COUNTS"
MISSING_CONSTANT = -1
DESCRIPTION    = "This field contains ion counts from channels D1-
                  D10. Items without values indicate channels not
                  counted during the interval. Values of zero
                  denote counted channels in which no ions were
                  detected. Values of -1 denote corrupted data,
                  excluded from the data file (counted, but value
                  undefined)."
```

END OBJECT = FIELD  
END\_OBJECT = SPREADSHEET  
END

## **A.28 TABLE**

TABLEs are a natural storage format for collections of data from many instruments. They are often the most effective way of storing much of the meta-data used to identify and describe instrument observations.

The TABLE object is a uniform collection of rows containing ASCII or binary values stored in columns. The INTERCHANGE\_FORMAT keyword is used to distinguish between TABLEs containing only ASCII columns and those containing binary data. The rows and columns of the TABLE object provide a natural correspondence to the records and fields often defined in interface specifications for existing data products. Each field is defined as a fixed-width COLUMN object; the value of the COLUMNS keyword is the total number of COLUMN objects defined in the label. All TABLE objects must have fixed-width records.

Many variations on the basic TABLE object are possible with the addition of optional keywords and/or objects. While it is possible to create very complex row structures, these are often not the best choices for archival data products. Recommended ASCII and binary table formats are described and illustrated below.

### **A.28.1 Keywords**

#### **A.28.1.1 Required Keywords**

1. INTERCHANGE\_FORMAT
2. ROWS
3. COLUMNS
4. ROW\_BYTES

#### **A.28.1.2 Optional Keywords**

1. NAME
2. DESCRIPTION
3. ROW\_PREFIX\_BYTES
4. ROW\_SUFFIX\_BYTES
5. TABLE\_STORAGE\_TYPE

#### **A.28.1.3 Required Objects**

1. COLUMN

#### **A.28.1.4 Optional Objects**

# 1. CONTAINER

## A.28.2 ASCII vs. BINARY formats

ASCII tables provide the most portable format for access across a wide variety of computer platforms. They are also easily imported into a number of database management systems and spreadsheet applications. For these reasons, the PDS recommends the use of ASCII table formats whenever possible for archive products.

ASCII formats are generally less efficient for storing large quantities of numeric data. In addition, raw or minimally processed data products and many pre-existing data products undergoing restoration are only available in binary formats. Where conversion to an ASCII format is not cost effective or is otherwise undesirable, BINARY table formats may be used.

## A.28.3 Recommended ASCII TABLE Format

The recommended format for ASCII TABLE files is a comma-separated value format in which the string fields are enclosed in double quotes. ASCII tables must have fixed-length records and should use carriage-return/linefeed (<CR><LF>) delimiters. Numeric fields are right-justified in the allotted space and character fields are left-justified and blank padded on the right. This table format can be imported directly into many commercial data management systems.

The field delimiters and quotation marks must occur between the defined COLUMNS. That is, the START\_BYTE for a string column should not point to the opening quotation mark, but the first character in the field itself. Similarly, the BYTES values for the columns should not include the commas at the end of the values. For example, a twelve character COLUMN called SPACECRAFT\_NAME would be represented in the table as "VOYAGER 1" rather than "VOYAGER 1" or "VOYAGER 1".

The following label fragment illustrates the general characteristics of the recommended ASCII TABLE format for a table with 1000-byte records:

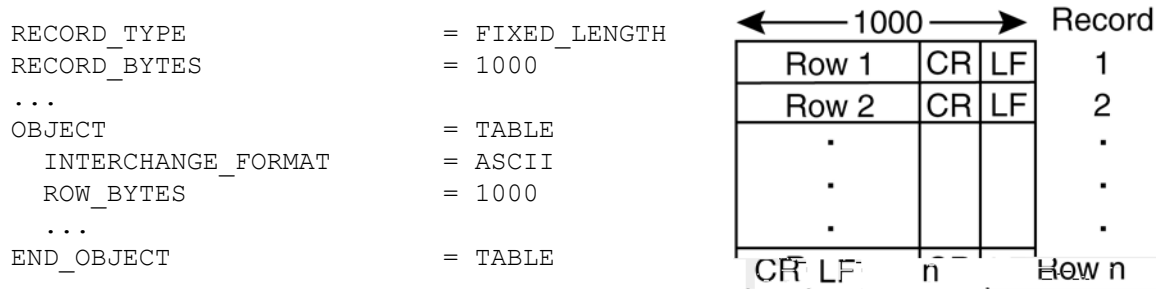

### A.28.3.1 Example - Recommended ASCII TABLE

The following example is an ASCII index table with 71-byte records. Note that for ASCII tables, the delimiters (double quotes and commas) and line terminators (<CR><LF>) *are* included in the byte count for each record (RECORD\_BYTES). In this example, the delimiters are also included in the byte count for each row (ROW\_BYTES). The <CR><LF> characters have been placed in columns 70 and 71.

**Note:** The example following is an INDEX\_TABLE, a specific type of (ASCII) TABLE object. Two rows of numbers indicating the byte count (read vertically) have been added above the data file contents to facilitate comparison with the label. These rows would *not* appear in the actual data file.

Contents of file "INDEX.TAB":

```
0000000001111111111222222222233333333333444444444455555555556666666666 7 7
123456789012345678901234567890123456789012345678901234567890123456789 0 1
"F-MIDR ", "F-MIDR.40N286;1 ", "C", 42, 37,289,282, "F40N286/FRAME.LBL "<CR><LF>
"F-MIDR ", "F-MIDR.20N280;1 ", "C", 22, 17,283,277, "F20N280/FRAME.LBL "<CR><LF>
"F-MIDR ", "F-MIDR.20N286;1 ", "C", 22, 17,289,283, "F20N286/FRAME.LBL "<CR><LF>
"F-MIDR ", "F-MIDR.00N279;1 ", "R", 2, -2,281,275, "F00N279/FRAME.LBL "<CR><LF>
"F-MIDR ", "F-MIDR.05N290;1 ", "C", 7, 2,292,286, "F05N290/FRAME.LBL "<CR><LF>
"F-MIDR ", "F-MIDR.05S279;1 ", "R", -2, -7,281,275, "F05S279/FRAME.LBL "<CR><LF>
"F-MIDR ", "F-MIDR.10S284;1 ", "C", -7,-12,287,281, "F10S284/FRAME.LBL "<CR><LF>
"F-MIDR ", "F-MIDR.10S290;1 ", "R", -7,-12,292,286, "F10S290/FRAME.LBL "<CR><LF>
"F-MIDR ", "F-MIDR.15S283;1 ", "R", -12,-17,286,279, "F15S283/FRAME.LBL "<CR><LF>
"F-MIDR ", "F-MIDR.15S289;1 ", "R", -12,-17,291,285, "F15S289/FRAME.LBL "<CR><LF>
```

Contents of file "INDEX.LBL":

```
PDS_VERSION_ID           = PDS3
RECORD_TYPE              = FIXED_LENGTH
RECORD_BYTES            = 71
FILE_RECORDS            = 10
^INDEX_TABLE            = "INDEX.TAB"

DATA_SET_ID              = "MGN-V-RDRS-5-MIDR-FULL-RES-V1.0"
VOLUME_ID                = MG_7777
PRODUCT_ID              = "FMIDR.XYZ"
SPACECRAFT_NAME         = MAGELLAN
INSTRUMENT_NAME         = "RADAR SYSTEM"
TARGET_NAME             = VENUS
PRODUCT_CREATION_TIME   = 1999-02-23t11:15:07
MISSION_PHASE_NAME      = PRIMARY_MISSION
NOTE                    = "This table lists all MIDRs on this
                           volume. It also includes the latitude and longitude range for each
                           MIDR and the directory in which it is found."
```

OBJECT	= INDEX_TABLE
INTERCHANGE_FORMAT	= ASCII
ROWS	= 10
COLUMNS	= 8
ROW_BYTES	= 71
INDEX_TYPE	= SINGLE
OBJECT	= COLUMN
NAME	= PRODUCT_TYPE
DESCRIPTION	= "Magellan DMAT type code. Possible values are F-MIDR, C1-MIDR, C2-MIDR, C3-MIDR, and P-MIDR."
DATA_TYPE	= CHARACTER
START_BYTE	= 2
BYTES	= 7
END_OBJECT	= COLUMN
OBJECT	= COLUMN
NAME	= PRODUCT_ID
DESCRIPTION	= "Magellan DMAT name of product. Example: F-MIDR.20N334;1"
DATA_TYPE	= CHARACTER
START_BYTE	= 12
BYTES	= 16
END_OBJECT	= COLUMN
OBJECT	= COLUMN
NAME	= SEAM_CORRECTION_TYPE
DESCRIPTION	= "A value of C indicates that cross-track seam correction has been applied. A value of R indicates that the correction has not been applied."
DATA_TYPE	= CHARACTER
START_BYTE	= 31
BYTES	= 1
END_OBJECT	= COLUMN
OBJECT	= COLUMN
NAME	= MAXIMUM_LATITUDE
DESCRIPTION	= "Northernmost frame latitude rounded to the nearest degree."
DATA_TYPE	= INTEGER
UNIT	= DEGREE
START_BYTE	= 34
BYTES	= 3
END_OBJECT	= COLUMN
OBJECT	= COLUMN
NAME	= MINIMUM_LATITUDE
DESCRIPTION	= "Southernmost frame latitude rounded to the nearest degree."
DATA_TYPE	= INTEGER
UNIT	= DEGREE
START_BYTE	= 38

```

        BYTES = 3
    END_OBJECT = COLUMN

    OBJECT = COLUMN
        NAME = EASTERNMOST_LONGITUDE
        DESCRIPTION = "Easternmost frame longitude rounded to
            the nearest degree."
        DATA_TYPE = INTEGER
        UNIT = DEGREE
        START_BYTE = 42
        BYTES = 3
    END_OBJECT = COLUMN

    OBJECT = COLUMN
        NAME = WESTERNMOST_LONGITUDE
        DESCRIPTION = "Westernmost frame longitude rounded to
            the nearest degree."
        DATA_TYPE = INTEGER
        UNIT = DEGREE
        START_BYTE = 46
        BYTES = 3
    END_OBJECT = COLUMN

    OBJECT = COLUMN
        NAME = FILE_SPECIFICATION_NAME
        DESCRIPTION = "Path and file name of frame table
            relative to CD-ROM root directory."
        DATA_TYPE = CHARACTER
        START_BYTE = 51
        BYTES = 18
    END_OBJECT = COLUMN

    END_OBJECT = INDEX_TABLE
END

```

#### A.28.4 Recommended BINARY TABLE Format

In the case of binary data, PDS recommends a format in which one data record corresponds to one row in the TABLE. Unused or spare bytes embedded within the record should be defined as COLUMNS (one for each chunk of contiguous unused bytes) named "SPARE", both for completeness and to facilitate automated validation of the TABLE structure. For reasons of portability, BIT\_COLUMN objects within COLUMNS are discouraged. Whenever possible, bit fields should be unpacked into more portable, byte-oriented COLUMNS.



The following label fragment illustrates the general characteristics of the recommended binary TABLE format for a table with 1000-byte records:

RECORD_TYPE	=	FIXED_LENGTH	← 1000 →		Record
RECORD_BYTES	=	1000			
...					
OBJECT	=	TABLE			
INTERCHANGE_FORMAT	=	BINARY			
ROW_BYTES	=	1000			
...					
END_OBJECT	=	TABLE			

Row 1	1
Row 2	2
.	.
.	.
.	.
Row n	n

### A.28.4.1 Example - Recommended Binary TABLE

Following is an example of a binary table containing three columns of data. The first two columns provide TIME information in both the PDS standard UTC format and an alternate format. The third column provides uncalibrated instrument measurements for the given time. The binary data reside in the file "T890825.DAT". The detached label file, "T890825.LBL" providing the complete description, is presented below.

**Note:** The label makes use of a format file, pointed to by the ^STRUCTURE keyword in the TABLE definition, to include a set of column definitions held in an external file ("CRSDATA.FMT"). The contents of this structure file are also provided below.

This table could also be represented as a TIME\_SERIES by the addition of sampling parameter keywords to describe the row-to-row variation in the table.

Contents of label file "T890825.DAT":

byte	1	8 9	32 33	36		<u>Record</u>
					Row 1	1
					C TIME	.
					PDS TIME	.
					D1 RATE	.
					.	.
					Row 350	350

## Contents of label file "T890825.LBL":

```

PDS_VERSION_ID          = PDS3

/* File Characteristic Keywords */
RECORD_TYPE             = FIXED_LENGTH
RECORD_BYTES            = 36
FILE_RECORDS            = 350
HARDWARE_MODEL_ID       = "SUN SPARC STATION"
OPERATING_SYSTEM_ID     = "SUN OS 4.1.1"

/* Data Object Pointers */
^TABLE                  = "T890825.DAT"

/* Identification Keywords */
DATA_SET_ID             = "VG2-N-CRS-4-SUMM-D1-96SEC-V1.0"
SPACECRAFT_NAME         = "VOYAGER 2"
INSTRUMENT_NAME         = "COSMIC RAY SYSTEM"
TARGET_NAME             = NEPTUNE
START_TIME              = 1989-08-25T00:00:00.000
STOP_TIME               = 1989-08-25T09:58:02.000
MISSION_PHASE_NAME      = "NEPTUNE ENCOUNTER"
PRODUCT_ID              = "T890825.DAT"
PRODUCT_CREATION_TIME   = "UNK"
SPACECRAFT_CLOCK_START_COUNT = "UNK"
SPACECRAFT_CLOCK_STOP_COUNT = "UNK"

/* Data Object Descriptions */
OBJECT                  = TABLE
  INTERCHANGE_FORMAT    = BINARY
  ROWS                  = 350
  COLUMNS              = 3
  ROW_BYTES            = 36
  ^STRUCTURE           = "CRSDATA.FMT"
END_OBJECT              = TABLE
END

```

## Contents of file "CRSDATA.FMT":

```

OBJECT                  = COLUMN
  NAME                  = "C TIME"
  UNIT                  = "SECOND"
  DATA_TYPE            = REAL
  START_BYTE           = 1
  BYTES                 = 8
  MISSING               = 1.0E+32
  DESCRIPTION           = "Time column. This field contains time
                           in seconds after Jan 01, 1966 but is
                           displayed in the default time format
                           selected by the user."
END_OBJECT              = COLUMN

```

```

OBJECT                = COLUMN
  NAME                = "PDS TIME"
  UNIT                = "TIME"
  DATA_TYPE          = TIME
  START_BYTE          = 9
  BYTES               = 24
  DESCRIPTION         = "Date/Time string of the form yyyy-mm-
                        ddThh:mm:ss.sss such that the representation of the date Jan 01,
                        2000 00:00:00.000 would be 2000-01-01T00:00:00.000."
END_OBJECT            = COLUMN

OBJECT                = COLUMN
  NAME                = "D1 RATE"
  UNIT                = "COUNT"
  DATA_TYPE          = "REAL"
  START_BYTE          = 33
  BYTES               = 4
  MISSING             = 1.0E+32
  DESCRIPTION         = "The D1 rate is approximately
                        porportional to the omnidirectional flux of electrons with kinetic
                        energy > ~1MeV. To obtain greater accuracy, the D1 calibration
                        tables (see catalog) should be applied."
END_OBJECT            = COLUMN

```

### A.28.5 TABLE Variations

This section addresses a number of variations on the basic TABLE object that arise when TABLES appear in data files with other objects, or where file attributes may differ from the one row-one record approach recommended above. The variations discussed below are equally applicable to the other TABLE-type objects, SERIES and SPECTRUM.

This section is not intended to be a complete reference for TABLE variations. Within the following examples, some illustrate a recommended data modelling approach, some illustrate alternate approaches, and other examples are included solely to document their existence.

#### A.28.5.1 Record blocking in Fixed Length TABLES

In the PDS recommended TABLE format, ROW\_BYTES = RECORD\_BYTES, but this is not always achievable. TABLES are sometimes packaged with other objects in the same file, or binary data may be blocked into larger records, both resulting in cases where the TABLE row size will not match the file record width.

Rows in either ASCII or binary tables may be either larger or smaller than the physical record size specified by the RECORD\_BYTES keyword. Regardless of the relationship between row size and record size, the RECORD\_BYTES keyword must *always* reflect the actual physical record size, while ROW\_BYTES must *always* be the logical size of one row of the TABLE object.

**A.28.5.1.1 Example: Binary Table with ROW\_BYTES > RECORD\_BYTES**

The following label fragment illustrates a case in which the record size of the file is smaller than the row size of the TABLE. Note that the table rows may straddle record boundaries. Each object, however, must begin on a record boundary, so it is possible that some padding may be required between the end of the TABLE object and the beginning of the IMAGE object, depending on the number of rows in the TABLE:

```

RECORD_TYPE      = FIXED_LENGTH
RECORD_BYTES     = 800
^TABLE           = ("IMAGE.IMG", 1)
^IMAGE           = ("IMAGE.IMG", 7)
...
OBJECT           = TABLE
  INTERCHANGE_FORMAT = BINARY
  ROW_BYTES       = 1200
...
END_OBJECT      = TABLE

OBJECT           = IMAGE
  SAMPLES        = 800
  SAMPLE_BITS    = 8
...
END_OBJECT      = IMAGE
    
```

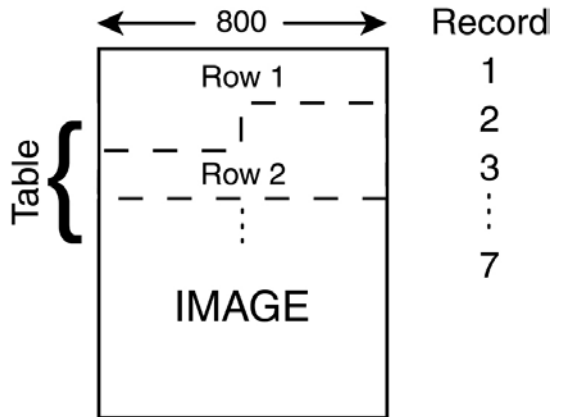

**A.28.5.1.2 Example: ASCII Table with ROW\_BYTES < RECORD\_BYTES**

The label fragment below illustrates a case in which the row size of the TABLE is smaller than the record size of the file. It is not required that the file record size be an integral multiple of the table row size; as illustrated above, table rows may straddle record boundaries. Also as above, it is possible that some padding will be required to ensure that the subsequent SERIES object begins on a record boundary.

```

RECORD_TYPE      = FIXED_LENGTH
RECORD_BYTES     = 800
^TABLE           = ("EXAMPLE.TAB", 1)
^SERIES          = ("EXAMPLE.TAB", 1214)
...
OBJECT           = TABLE
  INTERCHANGE_FORMAT = ASCII
  ROW_BYTES       = 400
...
END_OBJECT      = TABLE

OBJECT           = SERIES
  INTERCHANGE_FORMAT = ASCII
  ROW_BYTES       = 800
    
```

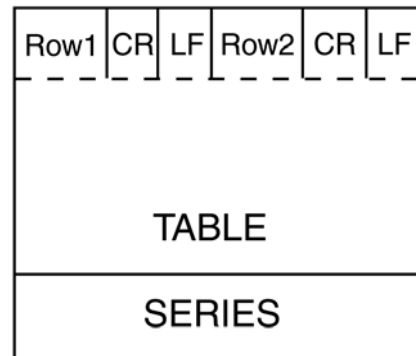

```

...
END_OBJECT          = SERIES

```

### A.28.5.1.3 Example: Binary Table with ROW\_BYTES < RECORD\_BYTES

It is often the case that a data object such as a TABLE is preceded by a header containing observational parameters or, as frequently happens with TABLES, a set of column headings. The label below illustrates a case in which a HEADER object containing a single 500-byte row precedes a TABLE having 1032-byte records. The file is physically blocked into records of 32,500 bytes. Note that in this case the HEADER record is *not* padded out to the full block size. Instead, a byte offset (rather than a record offset) is used to indicate the start of the TABLE object. (This example also includes COLUMN definitions contained in an external format file, a fragment of the contents of which is also shown below, following the label.)

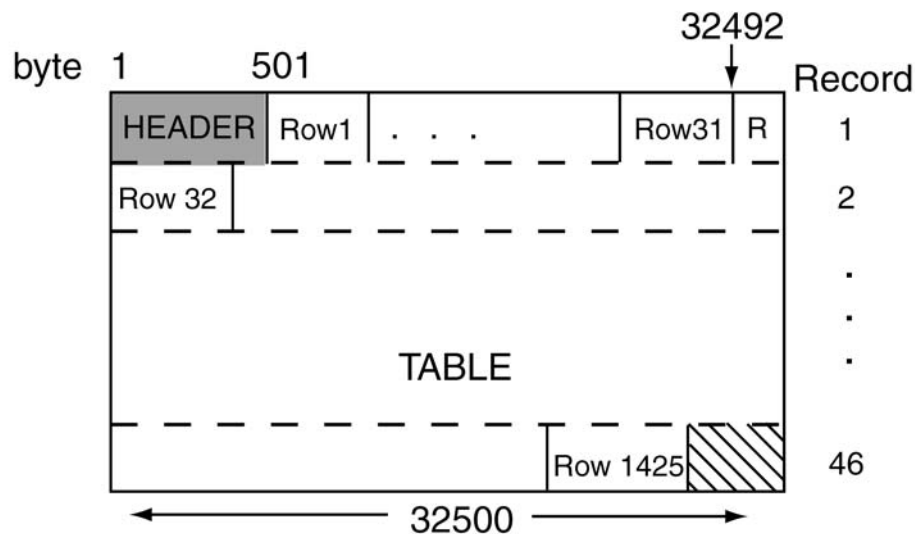

```

PDS_VERSION_ID          = PDS3

/* FILE CHARACTERISTICS */
RECORD_TYPE              = FIXED_LENGTH
RECORD_BYTES             = 32500
FILE_RECORDS             = 46
^HEADER                  = ("ADF01141.3",1)
^TABLE                   = ("ADF01141.3",501<BYTES>)

/* IDENTIFICATION KEYWORDS */
DATA_SET_ID              = "MGN-V-RDRS-5-CDR-ALT/RAD-V1.0"
PRODUCT_ID               = "ADF01141.3"
TARGET_NAME              = VENUS
SPACECRAFT_NAME          = MAGELLAN
INSTRUMENT_NAME          = "RADAR SYSTEM"
MISSION_PHASE_NAME       = PRIMARY_MISSION
PRODUCT_CREATION_TIME    = 1991-07-23T06:16:02.000
ORBIT_NUMBER              = 1141

```

```

START_TIME                = UNK
STOP_TIME                 = UNK
SPACECRAFT_CLOCK_START_COUNT = UNK
SPACECRAFT_CLOCK_STOP_COUNT = UNK
HARDWARE_VERSION_ID      = 01
SOFTWARE_VERSION_ID      = 02
UPLOAD_ID                 = M0356N
NAVIGATION_SOLUTION_ID   = "ID = M0361-12 "
DESCRIPTION                = "This file contains binary records
                             describing, in time order, each altimeter footprint measured
                             during an orbit of the Magellan radar mapper."

/* DATA OBJECT DEFINITION  DESCRIPTIONS */
OBJECT                    = HEADER
  HEADER_TYPE             = SFDU
  BYTES                   = 500
END_OBJECT                = HEADER

OBJECT                    = TABLE
  INTERCHANGE_FORMAT      = BINARY
  ROWS                    = 1425
  COLUMNS                = 40
  ROW_BYTES               = 1032
  ^STRUCTURE              = "ADFTBL.FMT"
END_OBJECT                = TABLE
END

```

#### Contents of format file "ADFTBL.FMT":

```

OBJECT                    = COLUMN
  NAME                    = SFDU_LABEL_AND_LENGTH
  START_BYTE              = 1
  DATA_TYPE              = CHARACTER
  BYTES                   = 20
  UNIT                    = "N/A"
  DESCRIPTION             = "The SFDU_label_and_length element
                             identifies the label and length of the Standard Format Data Unit
                             (SFDU)."
```

```

END_OBJECT                = COLUMN

OBJECT                    = COLUMN
  NAME                    = FOOTPRINT_NUMBER
  START_BYTE              = 21
  DATA_TYPE              = LSB_INTEGER
  BYTES                   = 4
  UNIT                    = "N/A"
  DESCRIPTION             = "The footprint_number element provides a
                             signed integer value. The altimetry and radiometry processing
                             program assigns footprint 0 to that observed at nadir at periapsis.
                             The remaining footprints are located along the spacecraft nadir
                             track, with a separation that depends on the Doppler resolution of
                             the altimeter at the epoch at which that footprint is observed. Pre-
                             periapsis footprints will be assigned negative numbers, post-
```

```

    periapsis footprints will be assigned positive ones. A loss of
    several consecutive burst records from the ALT-EDR will result in
    missing footprint numbers."
END_OBJECT                = COLUMN
...

OBJECT                    = COLUMN
  NAME                    = DERIVED_THRESH_DETECTOR_INDEX
  START_BYTE              = 1001
  DATA_TYPE              = LSB_UNSIGNED_INTEGER
  BYTES                   = 4
  UNIT                    = "N/A"
  DESCRIPTION              = "The derived_thresh_detector_index
    element provides the value of the element in
    range_sharp_echo_profile that satisfies the altimeter threshold
    detection algorithm, representing the distance to the nearest object
    in this radar footprint in units of 33.2 meters, modulus a 10.02
    kilometer altimeter range ambiguity."
END_OBJECT                = COLUMN

```

#### A.28.5.1.4 *Example: PDS Recommended Method for Dealing with Odd-Sized Headers*

The preceding format may be difficult to deal with in some cases because of the odd-sized header preceding the TABLE object. The recommended approach to this situation is pad the HEADER object out to an integral multiple of the TABLE row size, and then let RECORD\_BYTES = ROW\_BYTES. Modifying the above case accordingly would yield the following:

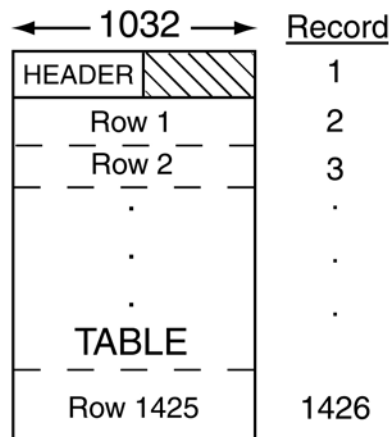

```

RECORD_TYPE              = FIXED_LENGTH
RECORD_BYTES             = 1032
FILE_RECORDS             = 1426
^HEADER                  = ("ADF01141.3",1)
^TABLE                   = ("ADF01141.3",2)
...

```

```

/* DATA OBJECT DEFINITIONS */
OBJECT                = HEADER
  HEADER_TYPE         = SFDU
  BYTES               = 500
END_OBJECT

OBJECT                = TABLE
  INTERCHANGE_FORMAT = BINARY
  ROWS                = 1425
  COLUMNS            = 40
  ROW_BYTES           = 1032
  ^STRUCTURE         = "ADFTBL.FMT"
END_OBJECT
END

```

#### A.28.5.1.5 *Alternate Format – Rows on Record Boundaries*

The following label fragment and illustration provide a second alternate data organization for the preceding example. In this example, a record size of 30,960 is used to hold 30 rows of the TABLE. Again the 500-byte HEADER uses only a portion of the first record.

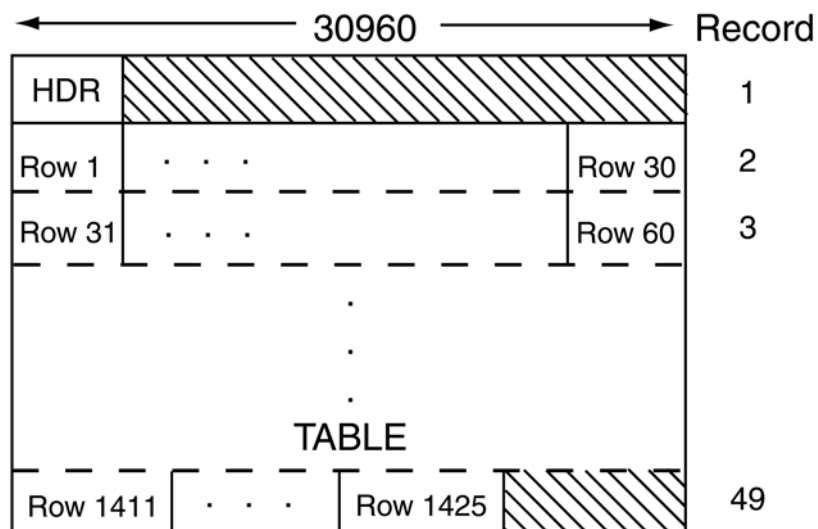

```

...
RECORD_TYPE           = FIXED_LENGTH
RECORD_BYTES         = 30960
FILE_RECORDS         = 49
^HEADER              = ("ADF01141.3",1)
^TABLE               = ("ADF01141.3")
...

```

```

/* DATA OBJECT DEFINITIONS */

```

```

OBJECT                = HEADER

```



```

    HEADER_TYPE           = SFDU
    BYTES                 = 500
    END_OBJECT           = HEADER

    OBJECT                = TABLE
    INTERCHANGE_FORMAT   = BINARY
    ROWS                  = 1425
    COLUMNS              = 40
    ROW_BYTES             = 1032
    ^STRUCTURE           = "ADFTBL.FMT"
    END_OBJECT           = TABLE

```

### A.28.5.2 Multiple TABLEs in a Single Data File

A single data product file may contain several ASCII or binary TABLEs, each with a different logical row size. There are several possible approaches to formatting such a product file, depending on whether the product contains binary or ASCII data. When all the TABLEs in the data file are ASCII tables there are two formatting options: fixed-length file records or stream records. When binary data are involved, even if only in a single TABLE, fixed-length file records are mandatory.

#### A.28.5.2.1 Example: Multiple ASCII tables – Fixed-Length Records

In the case of a series of ASCII TABLE objects with varying ROW\_BYTES values, a fixed-length record file may be generated by padding all rows of all TABLEs out to the length of the longest rows by adding blank characters between the end of the last COLUMN and the <CR><LF> record delimiters.

When this approach is used, RECORD\_TYPE is FIXED\_LENGTH and RECORD\_BYTES = ROW\_BYTES.

```

    RECORD_TYPE           = FIXED_LENGTH
    RECORD_BYTES         = 1000
    ...
    OBJECT              = A_TABLE
    INTERCHANGE_FORMAT  = ASCII
    ROW_BYTES           = 1000
    ...
    END_OBJECT         = A_TABLE

    OBJECT              = B_TABLE
    INTERCHANGE_FORMAT  = ASCII
    ROW_BYTES           = 1000
    ...
    END_OBJECT         = B_TABLE

```

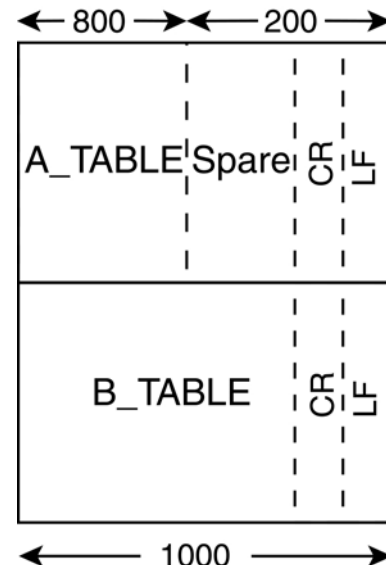

Note that each TABLE object has the same value of ROW\_BYTES, even though in the smaller table the rightmost bytes will be ignored. Alternately, the filler bytes may be documented as ROW\_SUFFIX\_BYTES. Say, for example, that in the above case B\_TABLE only required 780

bytes for its rows. The following definition for B\_TABLE marks the last 220 bytes of each row as suffix bytes:

```

OBJECT                = B_TABLE
INTERCHANGE_FORMAT   = ASCII
ROW_BYTES             = 780
ROW_SUFFIX_BYTES      = 220
...

```

#### A.28.5.2.2 *END\_OBJECT = B\_TABLE*

#### A.28.5.2.2 *Example: Multiple ASCII tables – Stream Records*

Sometimes padding TABLE records out to a common fixed length creates more problems than it solves. When this is true each TABLE should retain its own ROW\_BYTES value, without padding, and the file RECORD\_TYPE is set to STREAM. RECORD\_BYTES should be omitted. The following label fragment illustrates this situation.

```

RECORD_TYPE          = STREAM
...
OBJECT               = A_TABLE
INTERCHANGE_FORMAT   = ASCII
ROW_BYTES            = 802
...
END_OBJECT           = A_TABLE

OBJECT               = B_TABLE
INTERCHANGE_FORMAT   = ASCII
ROW_BYTES            = 1000
...
END_OBJECT           = B_TABLE

```

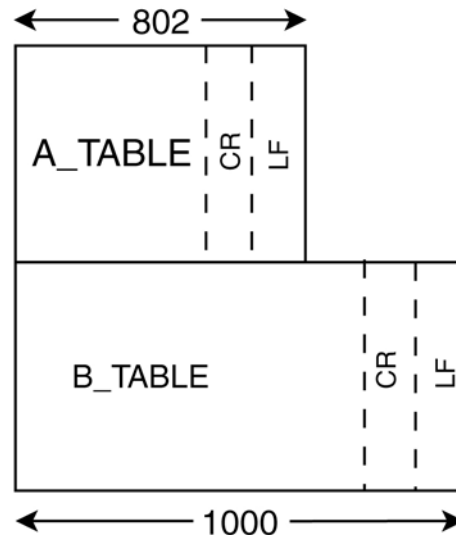

#### A.28.5.2.3 *Example: Multiple Binary Tables – Fixed-Length Records*

When binary data are involved the file records *must* be fixed-length. The records of the smaller TABLE(s) are padded, usually with null characters, out to the maximum ROW\_BYTES value in the file. The padding bytes are accounted for in the TABLE definition using one of two methods: either by defining a COLUMN called “SPARE” to define the number and location of these spare bytes, or by using the ROW\_SUFFIX\_BYTES keyword, as in the case of multiple ASCII tables. In the following example, the first table, A\_TABLE, has a logical row length of 800 bytes. Each row has been padded out to 1000 bytes, the length of the B\_TABLE rows, with a 200-byte SPARE column:

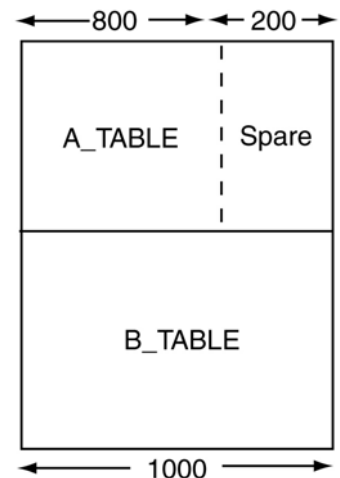

```

RECORD_TYPE           = FIXED_LENGTH
RECORD_BYTES         = 1000
...

OBJECT                = A_TABLE
  INTERCHANGE_FORMAT  = BINARY
  ROW_BYTES           = 1000
  ...

OBJECT                = COLUMN
  NAME                = "TIME TAG"
  DATA_TYPE          = TIME
  START_BYTE          = 1
  BYTES               = 23
  END_OBJECT          = COLUMN
  ...

OBJECT                = COLUMN
  NAME                = "SPARE"
  DATA_TYPE          = "N/A"
  START_BYTE          = 801
  BYTES               = 200
  END_OBJECT          = COLUMN
END_OBJECT            = A_TABLE

OBJECT                = B_TABLE
  INTERCHANGE_FORMAT  = BINARY
  ROW_BYTES           = 1000
  ...
END_OBJECT            = B_TABLE

```

### A.28.5.3 ROW\_PREFIX or ROW\_SUFFIX Use

ROW\_PREFIX\_BYTES and ROW\_SUFFIX\_BYTES are provided for dealing with two situations:

1. When a TABLE object is stored in parallel with another data object, frequently an IMAGE. In this case, each physical record of the file contains a TABLE row as one part of the record and an IMAGE line as the other part.
2. When a TABLE has had each of its rows padded out to a fixed length larger than the logical row size of the table.

Each method is illustrated below.

#### A.28.5.3.1 *Example: Parallel TABLE and IMAGE objects*

The following label fragment illustrates a file with fixed-length records, each of which contains one row of a TABLE data object and one line of an IMAGE object. This is a common format for providing ancillary information applicable to each IMAGE line. In the TABLE object the bytes

belonging to the IMAGE are accounted for as ROW\_SUFFIX\_BYTES. In the IMAGE object the bytes belonging to the TABLE row are accounted for as LINE\_PREFIX\_BYTES.

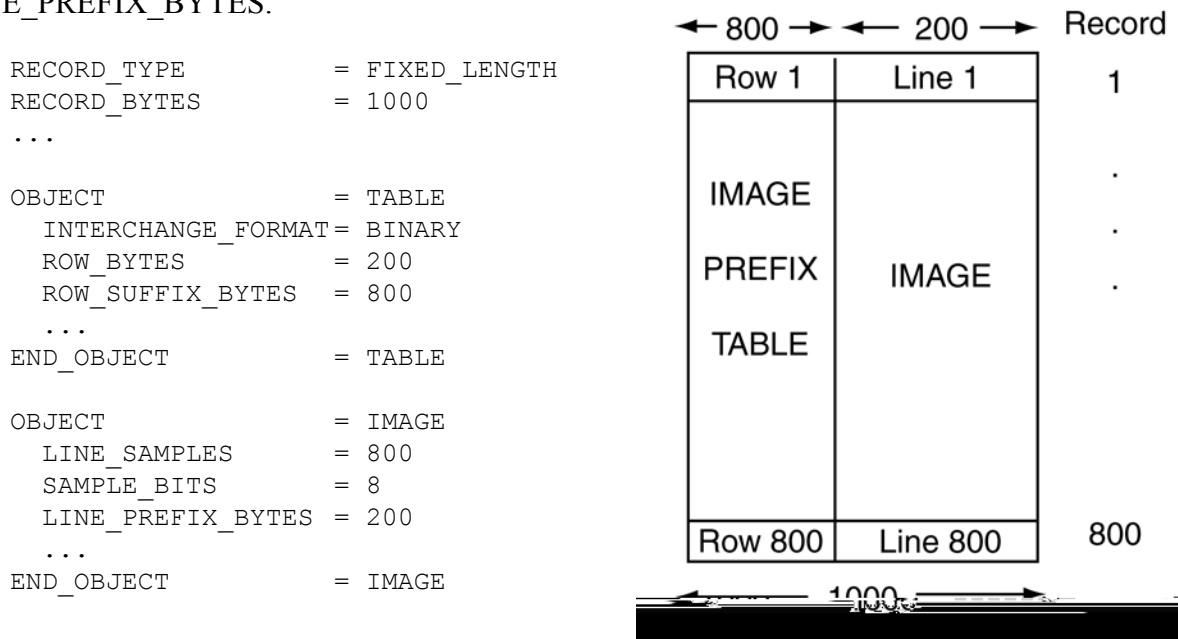

Note that in each object the total size of the logical record plus all prefix and suffix bytes is equal to the file record size. That is:

$$\text{RECORD\_BYTES} = \text{ROW\_BYTES} + \text{ROW\_PREFIX\_BYTES} + \text{ROW\_SUFFIX\_BYTES}$$

and

$$\text{RECORD\_BYTES} = (\text{LINE\_SAMPLES} * \text{SAMPLE\_BITS} / 8) + \text{ROW\_PREFIX\_BYTES} + \text{ROW\_SUFFIX\_BYTES}$$

#### A.28.5.4 CONTAINER Object use

Complex TABLEs may contain a set of columns of different data types which repeat a number of times in the row. In this case a CONTAINER object, which groups a set of inhomogeneous COLUMN objects, may be used to provide a single definition for the repeating group. Section A.8 contains an example of a TABLE object which makes use of a CONTAINER object.

#### A.28.5.5 Guidelines for SPARE fields

Some TABLE objects contain spare bytes embedded in the record but not included in any COLUMN object definition. They may be there for spacing or alignment purposes, or they may have been reserved in the original data record for future use. Regardless of their origin, PDS recommends that all such spare bytes be documented as COLUMNS in the TABLE definition in the interests of documentation and validation. Spare bytes may be included in both binary and ASCII table objects. Guidelines for dealing with spare bytes in both cases follow.

### A.28.5.6 SPARE fields - Binary Tables

The following guidelines apply to spare byte fields in binary table objects:

- Embedded spare fields must be explicitly defined in COLUMN objects, except when the spare field appears at the beginning or end of a row where ROW\_PREFIX\_BYTES or ROW\_SUFFIX\_BYTES is used.
- Spare COLUMNS must have DATA\_TYPE = "N/A".
- Multiple spare COLUMNS may all specify NAME = "SPARE".
- Spare bytes may occur as prefix or suffix bytes in the rows.
- Prefix or suffix spares may be identified either with a spare COLUMN object or by use of ROW\_PREFIX\_BYTES or ROW\_SUFFIX\_BYTES

The following examples illustrate the various situations.

#### A.28.5.6.1 Example: SPARE field embedded in a Binary TABLE

In the following label fragment, a spare column defines a series of bytes reserved for future use in the middle of the data record:

```

RECORD_TYPE          = FIXED_LENGTH
RECORD_BYTES         = 1000
...

OBJECT               = TABLE
  INTERCHANGE_FORMAT = BINARY
  ROW_BYTES           = 1000
  COLUMNS            = 99
  ...

OBJECT               = COLUMN
  NAME                = SPARE
  COLUMN_NUMBER       = 87
  START_BYTE          = 793
  BYTES                = 21
  DATA_TYPE          = "N/A"
  DESCRIPTION         = "Reserved for future user by Mission Ops."
  END_OBJECT          = COLUMN
  ...

OBJECT               = COLUMN
  ...

END_OBJECT            = TABLE

```

### A.28.5.6.2 Example: Spares at end of a Binary TABLE – Explicit 'SPARE' Column

In this label fragment, spare bytes have been included on the end of each record of the table. These bytes are described as an additional COLUMN at the end of the record.

```

RECORD_TYPE           = FIXED_LENGTH
RECORD_BYTES         = 1000
...

OBJECT               = TABLE
INTERCHANGE_FORMAT   = BINARY
ROW_BYTES            = 1000
COLUMNS             = 99
...

OBJECT               = COLUMN
COLUMN_NUMBER        = 1
NAME                 = "TIME TAG"
...
END_OBJECT

OBJECT               = COLUMN
COLUMN_NUMBER        = 99
NAME                 = SPARE
BYTES                = 20
DATA_TYPE            = "N/A"
START_BYTE           = 981
...
END_OBJECT           = COLUMN
END_OBJECT           = TABLE

```

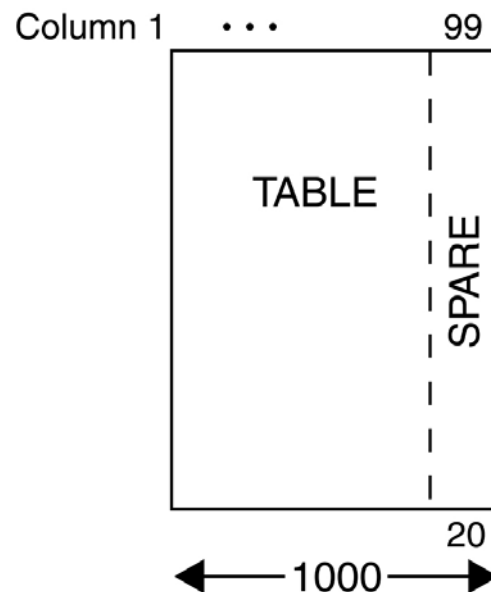

### A.28.5.6.3 Example: Spares at end of a Binary TABLE - ROW\_SUFFIX\_BYTES use

This fragment illustrates the same physical file layout as the previous example, but in this case the spare bytes are defined using the ROW\_SUFFIX\_BYTES keyword, rather than defining an additional spare COLUMN.

```

RECORD_TYPE           = FIXED_LENGTH
RECORD_BYTES         = 1000
...

OBJECT               = TABLE
INTERCHANGE_FORMAT   = BINARY
ROW_BYTES            = 980

```

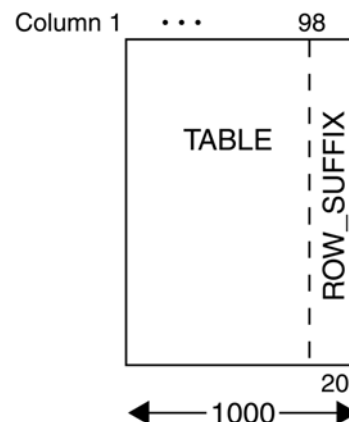

```

ROW_SUFFIX_BYTES    = 20
COLUMNS            = 98
...
END_OBJECT          = TABLE

```

### A.28.5.7 SPARE fields - ASCII Tables with Fixed Length Records

In ASCII tables, field delimiters (") and (,) and the <CR><LF> pair are considered part of the data, even though the COLUMN objects attributes do not include them. Spare bytes in ASCII tables may contain only the blank character (ASCII decimal code 32). The following guidelines apply to spare byte fields in ASCII table objects:

- Embedded spares are not allowed.
- Spares are allowed at the end of each row of data.
- The <CR><LF> follows the spare data.
- There are no delimiters (commas or quotes) surrounding the spares.
- Spares at the end of the data can be ignored (like field delimiters and <CR><LF>) or they can be identified
  - (1) in the Table DESCRIPTION; or
  - (2) by using ROW\_SUFFIX\_BYTES (note that these bytes should not be included in the value of ROW\_BYTES)

#### A.28.5.7.1 Example - SPARE field at end of ASCII TABLE - Table description note

```

RECORD_TYPE          = FIXED_LENGTH
RECORD_BYTES         = 1000
...

OBJECT               = TABLE
  INTERCHANGE_FORMAT = ASCII
  ROW_BYTES           = 1000
...

DESCRIPTION          ="This table contains 980
  bytes of table data followed by 18 bytes of
  blank spares. Bytes 999 and 1000 contain the
  <CR><LF> pair."

```

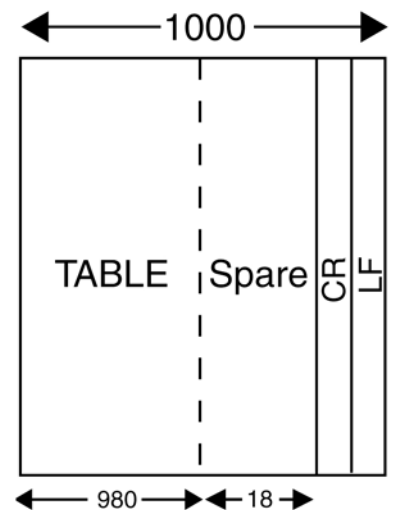

**A.28.5.7.2 Example - Spares at end of a ASCII TABLE - ROW\_SUFFIX use**

```

RECORD_TYPE           = FIXED_LENGTH
RECORD_BYTES         = 1000
...
OBJECT                = TABLE
  INTERCHANGE_FORMAT  = ASCII
  ROW_BYTES           = 980
  ROW_SUFFIX_BYTES    = 20
  ...
DESCRIPTION           ="This table contains
  980 bytes of table data followed by 20
  bytes of spare data of which the last
  two bytes, bytes 999 and 1000, contain
  the <CR><LF> pair."
END_OBJECT            = TABLE

```

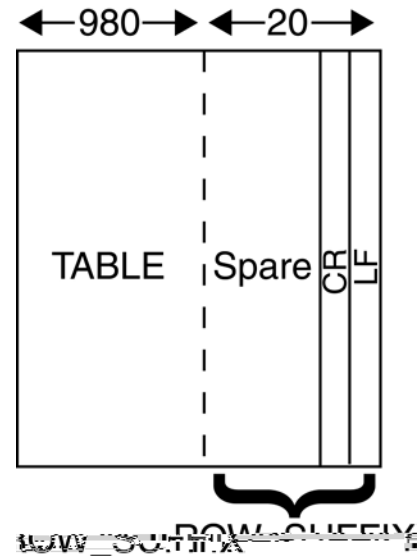
**A.28.5.8 SPARE fields - ASCII Tables with STREAM Records**

Spare fields are not used with ASCII Tables in STREAM record formats. In STREAM files, the last data field explicitly defined with a COLUMN object is followed immediately by the <CR><LF> pair. Since there is no use for spares at the end of the data, and embedded spares are not allowed in ASCII tables, spares are not applicable here.



## A.29 TEXT

The TEXT object describes a file which contains plain text. It is most often used in an attached label, so that the text begins immediately after the END statement of the label. PDS recommends that TEXT objects contain no special formatting characters, with the exception of the carriage return/line feed sequence and the page break. Tab characters are discouraged, since they are interpreted differently by different programs.

Use of the carriage-return/line-feed sequence (<CR><LF>) is required for cross-platform support. PDS further recommends that text lines be limited to 80 characters, with delimiters, to facilitate visual inspection and printing of text files.

NOTE: The TEXT object is most often used for files describing the contents of an archive volume or the contents of a directory, such as AAREADME.TXT, DOCINFO.TXT, VOLINFO.TXT, SOFTINFO.TXT, etc. These files must be in plain, unmarked ASCII text and always have a file extension of “.TXT”. Documentation files that are in plain ASCII text, on the other hand, must be described using the DOCUMENT object. (See the definition of the DOCUMENT Object in Section A.12.)

The required NOTE field should provide a brief introduction to the TEXT.

### A.29.1 Required Keywords

1. NOTE
2. PUBLICATION\_DATE

### A.29.2 Optional Keywords

1. INTERCHANGE\_FORMAT

### A.29.3 Required Objects

None

### A.29.4 Optional Objects

None

### A.29.5 Example

The example below is a portion of an AAREADME.TXT file.

```
PDS_VERSION_ID      = PDS3
RECORD_TYPE        = STREAM

OBJECT              = TEXT
  PUBLICATION_DATE  = 1991-05-28
  NOTE              = "Introduction to this CD-ROM volume."
END_OBJECT          = TEXT
END

                GEOLOGIC REMOTE SENSING FIELD EXPERIMENT
```

This set of compact read-only optical disks (CD-ROMs) contains a data collection acquired by ground-based and airborne instruments during the Geologic Remote Sensing Field Experiment (GRSFE). Extensive documentation is also included. GRSFE took place in July, September, and October, 1989, in the southern Mojave Desert, Death Valley, and the Lunar Crater Volcanic Field, Nevada. The purpose of these CD-ROMs is to make available in a compact form through the Planetary Data System (PDS) a collection of relevant data to conduct analyses in preparation for the Earth Observing System (EOS), Mars Observer (MO), and other missions. The generation of this set of CD-ROMs was sponsored by the NASA Planetary Geology and Geophysics Program, the Planetary Data System (PDS) and the Pilot Land Data System (PLDS).

This AAREADME.TXT file is one of the two nondirectory files located in the top level directory of each CD-ROM volume in this collection. The other file, VOLDESC.CAT, contains an overview of the data sets on these CD-ROMs and is written in a format that is designed for access by computers. These two files appear on every volume in the collection. All other files on the CD-ROMs are located in directories below the top level directory ....

## A.30 VOLUME

The VOLUME object describes a physical or logical unit used to store or distribute data products (e.g., a magnetic tape, CD-ROM disk, or floppy disk) that contain directories and files. The directories and files may include documentation, software, calibration and geometry information as well as the actual science data.

### A.30.1 Required Keywords

8. DATA\_SET\_ID
9. DESCRIPTION
10. MEDIUM\_TYPE
11. PUBLICATION\_DATE
12. VOLUME\_FORMAT
13. VOLUME\_ID
14. VOLUME\_NAME
15. VOLUME\_SERIES\_NAME
16. VOLUME\_SET\_NAME
17. VOLUME\_SET\_ID
18. VOLUME\_VERSION\_ID
19. VOLUMES

### A.30.2 Optional Keywords

13. BLOCK\_BYTES
14. DATA\_SET\_COLLECTION\_ID
15. FILES
16. HARDWARE\_MODEL\_ID
17. LOGICAL\_VOLUMES
18. LOGICAL\_VOLUME\_PATH\_NAME
19. MEDIUM\_FORMAT
20. NOTE
21. OPERATING\_SYSTEM\_ID
22. PRODUCT\_TYPE
23. TRANSFER\_COMMAND\_TEXT
24. VOLUME\_INSERT\_TEXT

### A.30.3 Required Objects

2. CATALOG
3. DATA\_PRODUCER

### A.30.4 Optional Objects

2. DIRECTORY
3. FILE
4. DATA\_SUPPLIER

### A.30.5 Example 1 (Typical CD-ROM Volume)

Please see the example in Section A.5 for the CATALOG object.

### A.30.6 Example 2 (Tape Volume)

The following VOLUME object example shows how directories and files are detailed when a volume is stored on an ANSI tape for transfer. This form of the VOLUME object should be used when transferring volumes of data on media which do not support hierarchical directory structures (for example, when submitting a volume of data on tape for premastering to CDROM). The VOLDESC.CAT file will contain the standard volume keywords, but the values of MEDIUM\_TYPE, MEDIUM\_FORMAT and VOLUME\_FORMAT should indicate that the volume is stored on tape.

In this example two files are defined in the root directory of the volume, VOLDESC.CAT and AAREADME.TXT. The first DIRECTORY object defines the CATALOG directory which contains meta data in the included, individual catalog objects. In this example, all the catalog objects are concatenated into a single file, CATALOG.CAT. The second DIRECTORY object defines an INDEX subdirectory containing three files: INDXINFO.TXT, INDEX.LBL, and INDEX.TAB. Following that directory, the first data directory is defined. Note that the SEQUENCE\_NUMBER keyword indicates the physical sequence of the files on the tape volume.

```

PDS_VERSION_ID          = PDS3
OBJECT                   = VOLUME
  VOLUME_SERIES_NAME     = "MISSION TO MARS"
  VOLUME_SET_NAME        = "MARS DIGITAL IMAGE MOSAIC AND DIGITAL
                          TERRAIN MODEL"
  VOLUME_SET_ID          = USA_NASA_PDS_VO_2001_TO_VO_2007
  VOLUMES                 = 7
  VOLUME_NAME            = "MDIM/DTM VOLUME 7: GLOBAL COVERAGE"
  VOLUME_ID              = VO_2007
  VOLUME_VERSION_ID     = "VERSION 1"
  PUBLICATION_DATE       = 1992-04-01
  DATA_SET_ID           = "VO1/VO2-M-VIS-5-DTM-V1.0"
  MEDIUM_TYPE            = "8-MM HELICAL SCAN TAPE"
  MEDIUM_FORMAT          = "2 GB"
  VOLUME_FORMAT          = ANSI
  HARDWARE_MODEL_ID      = "VAX 11/750"

```

```

OPERATING_SYSTEM_ID      = "VMS 4.6"
DESCRIPTION               = "This volume contains the Mars Digital
Terrain Model and Mosaicked Digital Image Model covering the entire
planet at resolutions of 1/64 and 1/16 degree/pixel.  The volume
also contains Polar Stereographic projection files of the north and
south pole areas from 80 to 90 degrees latitude; Mars Shaded Relief
Airbrush Maps at 1/16 and 1/ 4 degree/pixel; a gazetteer of Mars
features; and a table of updated viewing geometry files of the
Viking EDR images that comprise the MDIM."
MISSION_NAME              = VIKING
SPACECRAFT_NAME           = {VIKING_ORBITER_1,VIKING_ORBITER_2}
SPACECRAFT_ID             = {VO1,VO2}

OBJECT                    = DATA_PRODUCER
  INSTITUTION_NAME        = "U.S.G.S. FLAGSTAFF"
  FACILITY_NAME           = "BRANCH OF ASTROGEOLOGY"
  FULL_NAME               = "Eric M. Eliason"
  DISCIPLINE_NAME         = "IMAGE PROCESSING"
  ADDRESS_TEXT            = "Branch of Astrogeology
United States Geological Survey
2255 North Gemini Drive
Flagstaff, Arizona. 86001 USA"
END_OBJECT                = DATA_PRODUCER

OBJECT                    = CATALOG
  ^CATALOG                = "CATALOG.CAT"
END_OBJECT                = CATALOG

OBJECT                    = FILE
  FILE_NAME               = "VOLDESC.CAT"
  RECORD_TYPE             = STREAM
  SEQUENCE_NUMBER         = 1
END_OBJECT                = FILE

OBJECT                    = FILE
  FILE_NAME               = "AAREADME.TXT"
  RECORD_TYPE             = STREAM
  SEQUENCE_NUMBER         = 2
END_OBJECT                = FILE

OBJECT                    = DIRECTORY
  NAME                    = CATALOG

  OBJECT                  = FILE
    FILE_NAME             = "CATALOG.CAT"
    RECORD_TYPE           = STREAM
    SEQUENCE_NUMBER       = 3
  END_OBJECT              = FILE
END_OBJECT                = DIRECTORY

OBJECT                    = DIRECTORY
  NAME                    = DOCUMENT

```

```

OBJECT                = FILE
  FILE_NAME           = "VOLINFO.TXT"
  RECORD_TYPE         = STREAM
  SEQUENCE_NUMBER     = 4
  END_OBJECT          = FILE

OBJECT                = FILE
  FILE_NAME           = "DOCINFO.TXT"
  RECORD_TYPE         = STREAM
  SEQUENCE_NUMBER     = 5
  END_OBJECT          = FILE
END_OBJECT            = DIRECTORY

OBJECT                = DIRECTORY
  NAME                = INDEX

OBJECT                = FILE
  FILE_NAME           = "INDXINFO.TXT"
  RECORD_TYPE         = STREAM
  SEQUENCE_NUMBER     = 6
  END_OBJECT          = FILE

OBJECT                = FILE
  FILE_NAME           = "INDEX.LBL"
  RECORD_TYPE         = STREAM
  SEQUENCE_NUMBER     = 7
  END_OBJECT          = FILE

OBJECT                = FILE
  FILE_NAME           = "INDEX.TAB"
  RECORD_TYPE         = FIXED_LENGTH
  RECORD_BYTES        = 512
  FILE_RECORDS        = 6822
  SEQUENCE_NUMBER     = 8
  END_OBJECT          = FILE
END_OBJECT            = DIRECTORY

OBJECT                = DIRECTORY
  NAME                = MG00NXXX

OBJECT                = FILE
  FILE_NAME           = "MG00N012.IMG"
  RECORD_TYPE         = FIXED_LENGTH
  RECORD_BYTES        = 964
  FILE_RECORDS        = 965
  SEQUENCE_NUMBER     = 10
  END_OBJECT          = FILE
END_OBJECT            = DIRECTORY

END_OBJECT            = VOLUME
END

```

### A.30.7 Example 3 (Logical Volumes in an Archive Volume)

The following examples illustrate the use of the VOLUME object in the top level and at the logical volume level of an archive volume. Note that the VOLUME object is *required* at both levels.

In these examples, the CD-ROM is structured as three separate logical volumes with root directories named PPS/, UVS/ and RSS/. An additional SOFTWARE directory is supplied at volume root for use with all logical volumes.

#### A.30.7.1 Logical Volumes – Volume Object (root level)

The example below, illustrates the use of the VOLUME object at the top level of a CD-ROM (i.e., a physical volume) containing several logical volumes. Note the values of the keywords DATA\_SET\_ID, LOGICAL\_VOLUMES, and LOGICAL\_VOLUME\_PATH\_NAME, which list the complete set of values relevant to this volume.

```

PDS_VERSION_ID          = PDS3
OBJECT                  = VOLUME
  VOLUME_SERIES_NAME    = "VOYAGERS TO THE OUTER PLANETS"
  VOLUME_SET_NAME       = "PLANETARY RING OCCULTATIONS FROM
                          VOYAGER"
  VOLUME_SET_ID         = "USA_NASA_PDS_VG_3001"
  VOLUMES                = 1
  MEDIUM_TYPE           = "CD-ROM"
  VOLUME_FORMAT         = "ISO-9660"
  VOLUME_NAME           = "VOYAGER PPS/UVS/RSS RING OCCULTATIONS"
  VOLUME_ID             = "VG_3001"
  VOLUME_VERSION_ID     = "VERSION 1"
  PUBLICATION_DATE      = 1994-03-01
  DATA_SET_ID          = {"VG2-SR/UR/NR-PPS-4-OCC-V1.0",
                          "VG1/VG2-SR/UR/NR-UVS-4-OCC-V1.0",
                          "VG1/VG2-SR/UR/NR-RSS-4-OCC-V1.0"}
  LOGICAL_VOLUMES       = 3
  LOGICAL_VOLUME_PATH_NAME = {"PPS/", "UVS/", "RSS/"}
  DESCRIPTION           = "This volume contains the Voyager 1 and
                          Voyager 2 PPS/UVS/RSS ring occultation and ODR data sets. Included
                          are data files at a variety of levels of processing, plus ancillary
                          geometry, calibration and trajectory files plus software and
                          documentation."

```

This CD-ROM is structured as three separate logical volumes with root directories named PPS/, UVS/ and RSS/. An additional SOFTWARE directory is supplied at volume root for use with all logical volumes."

```

OBJECT                  = DATA_PRODUCER
  INSTITUTION_NAME     = "PDS RINGS NODE"
  FACILITY_NAME        = "NASA AMES RESEARCH CENTER"
  FULL_NAME            = "DR. MARK R. SHOWALTER"
  DISCIPLINE_NAME      = "RINGS"
  ADDRESS_TEXT         = "Mail Stop 245-3

```

```

                                NASA Ames Research Center
                                Moffett Field, CA 94035-1000"
END_OBJECT                       = DATA_PRODUCER

OBJECT                           = CATALOG
  DATA_SET_ID                   = "VG2-SR/UR/NR-PPS-4-OCC-V1.0"
  LOGICAL_VOLUME_PATH_NAME      = "PPS/"
  ^MISSION_CATALOG              = "MISSION.CAT"
  ^INSTRUMENT_HOST_CATALOG      = "INSTHOST.CAT"
  ^INSTRUMENT_CATALOG           = "INST.CAT"
  ^DATA_SET_COLLECTION_CATALOG  = "DSCOLL.CAT"
  ^DATA_SET_CATALOG             = "DATASET.CAT"
  ^REFERENCE_CATALOG            = "REF.CAT"
  ^PERSONNEL_CATALOG            = "PERSON.CAT"
END_OBJECT                       = CATALOG

OBJECT                           = CATALOG
  DATA_SET_ID                   = "VG1/VG2-SR/UR/NR-UVS-4-OCC-V1.0"
  LOGICAL_VOLUME_PATH_NAME      = "UVS/"
  ^MISSION_CATALOG              = "MISSION.CAT"
  ^INSTRUMENT_HOST_CATALOG      = "INSTHOST.CAT"
  ^INSTRUMENT_CATALOG           = "INST.CAT"
  ^DATA_SET_COLLECTION_CATALOG  = "DSCOLL.CAT"
  ^DATA_SET_CATALOG             = "DATASET.CAT"
  ^REFERENCE_CATALOG            = "REF.CAT"
  ^PERSONNEL_CATALOG            = "PERSON.CAT"
END_OBJECT                       = CATALOG

OBJECT                           = CATALOG
  DATA_SET_ID                   = "VG1/VG2-SR/UR/NR-RSS-4-OCC-V1.0"
  LOGICAL_VOLUME_PATH_NAME      = "RSS/"
  ^MISSION_CATALOG              = "MISSION.CAT"
  ^INSTRUMENT_HOST_CATALOG      = "INSTHOST.CAT"
  ^INSTRUMENT_CATALOG           = "INST.CAT"
  ^DATA_SET_COLLECTION_CATALOG  = "DSCOLL.CAT"
  ^DATA_SET_CATALOG             = "DATASET.CAT"
  ^REFERENCE_CATALOG            = "REF.CAT"
  ^PERSONNEL_CATALOG            = "PERSON.CAT"
END_OBJECT                       = CATALOG

END_OBJECT                       = VOLUME
END

```

### A.30.7.2 Logical Volumes – Volume Object (logical volume level)

The example below, illustrates the use of the VOLUME object required at the top level of a logical volume. Note that at this level the keywords DATA\_SET\_ID and LOGICAL\_VOLUME\_PATH\_NAME contain only the values relevant to the current logical volume. Also, the keyword LOGICAL\_VOLUMES does not appear here.

```

PDS_VERSION_ID                   = PDS3
OBJECT                           = VOLUME
  VOLUME_SERIES_NAME             = "VOYAGERS TO THE OUTER PLANETS"

```



```

VOLUME_SET_NAME           = "PLANETARY RING OCCULTATIONS
                           FROM VOYAGER"
VOLUME_SET_ID             = "USA_NASA_PDS_VG_3001"
VOLUMES                   = 1
MEDIUM_TYPE              = "CD-ROM"
VOLUME_FORMAT             = "ISO-9660"
VOLUME_NAME               = "VOYAGER PPS/UVS/RSS RING
                           OCCULTATIONS"
VOLUME_ID                 = "VG_3001"
VOLUME_VERSION_ID        = "VERSION 1"
PUBLICATION_DATE         = 1994-03-01
DATA_SET_ID               = "VG2-SR/UR/NR-PPS-4-OCC-V1.0"
LOGICAL_VOLUME_PATH_NAME = "PPS/"
DESCRIPTION               = "This logical volume contains the
                           Voyager 2 PPS ring occultation data sets. Included are data files at
                           a variety of levels of processing, plus ancillary geometry,
                           calibration and trajectory files plus software and documentation."

OBJECT                    = DATA_PRODUCER
  INSTITUTION_NAME        = "PDS RINGS NODE"
  FACILITY_NAME           = "NASA AMES RESEARCH CENTER"
  FULL_NAME               = "DR. MARK R. SHOWALTER"
  DISCIPLINE_NAME        = "RINGS"
  ADDRESS_TEXT            = "Mail Stop 245-3
                           NASA Ames Research Center
                           Moffett Field, CA 94035-1000"

END_OBJECT                = DATA_PRODUCER

OBJECT                    = CATALOG
  DATA_SET_ID            = "VG2-SR/UR/NR-PPS-4-OCC-V1.0"
  LOGICAL_VOLUME_PATH_NAME = "PPS/"
  ^MISSION_CATALOG       = "MISSION.CAT"
  ^INSTRUMENT_HOST_CATALOG = "INSTHOST.CAT"
  ^INSTRUMENT_CATALOG    = "INST.CAT"
  ^DATA_SET_COLLECTION_CATALOG = "DSCOLL.CAT"
  ^DATA_SET_CATALOG      = "DATASET.CAT"
  ^REFERENCE_CATALOG     = "REF.CAT"
  ^PERSONNEL_CATALOG     = "PERSON.CAT"

END_OBJECT                = CATALOG

END_OBJECT                = VOLUME
END

```

**A**

AAREADME.TXT, A-126  
ALIAS object  
    definition, A-3  
ARRAY object, A-1, A-39  
    definition, A-4  
ASCII tables, A-105  
AXIS\_ITEMS, A-4  
AXIS\_NAME, A-83

**B**

BAND\_BIN, A-81  
BAND\_STORAGE\_TYPE, A-68  
BANDS, A-68  
binary tables, A-108  
    spare bytes, A-108  
BIT\_COLUMN object, A-20, A-108  
    definition, A-8  
BIT\_ELEMENT object, A-1  
    definition, A-12  
BYTES, A-18, A-58, A-105

**C**

CATALOG object  
    definition, A-13  
CHECKSUM, A-70  
COLLECTION object, A-1, A-4, A-6, A-39  
    definition, A-16  
COLUMN object, A-3, A-8, A-88, A-104  
    and CONTAINER, A-23  
    definition, A-18  
    vectors, A-18  
CONTAINER object, A-18  
    definition, A-23  
    in TABLE, A-121

**D**

data objects, A-1  
    ALIAS, A-3  
    ARRAY, A-4

BIT\_COLUMN, A-8  
 BIT\_ELEMENT, A-12  
 CATALOG, A-13  
 COLLECTION, A-16  
 COLUMN, A-18  
 CONTAINER, A-23  
 DATA\_PRODUCER, A-30  
 DATA\_SUPPLIER, A-32  
 DIRECTORY, A-34  
 DOCUMENT, A-36  
 ELEMENT, A-39  
 FIELD, A-41  
 FILE, A-44  
 GAZETTEER\_TABLE, A-48  
 HEADER, A-58  
 HISTOGRAM, A-60  
 HISTORY, A-63  
 IMAGE, A-67, A-77  
 INDEX\_TABLE, A-72  
 PALETTE, A-77  
 QUBE, A-80  
 SERIES, A-88  
 SPECTRUM, A-93  
 SPICE\_KERNEL, A-96  
 SPREADSHEET, A-99  
 TABLE, A-104  
 TEXT, A-126  
 VOLUME, A-128  
 DATA\_PRODUCER object, A-32  
   definition, A-30  
 DATA\_SET object, A-44  
 DATA\_SET\_ID, A-133, A-134  
 DATA\_SUPPLIER object, A-30  
   definition, A-32  
 DIRECTORY object, A-130  
   definition, A-34  
 DOCINFO.TXT, A-126  
 document  
   ASCII version, A-36  
 DOCUMENT object  
   definition, A-36  
 documentation  
   file labelling  
     DOCUMENT object, use of, A-36  
 documents  
   and DOCUMENT object, A-36

**E**

ELEMENT object, A-1, A-6  
definition, A-39

**F**

field delimiters, A-123  
FIELD object  
definition, A-41  
example, A-42, A-43  
in SPREADSHEET, A-41  
FILE object, A-34  
definition, A-44  
implicit, A-44  
table of required and optional elements, A-45  
FILE\_NAME, A-44  
FILE\_STATE, A-81

**G**

GAZETTEER\_TABLE object  
definition, A-48  
GROUP  
in HISTORY object, A-63  
in QUBE, A-81

**H**

HEADER object, A-113  
definition, A-58  
HISTOGRAM object, A-81  
definition, A-60  
HISTORY object  
and QUBE, A-81  
definition, A-63

**I**

IMAGE object, A-77, A-81  
and PALETTE, A-77  
definition, A-67  
stored with TABLE object, A-120  
IMAGE\_MAP\_PROJECTION object, A-81  
INDEX\_TABLE  
contents, A-72

INDEX\_TABLE object  
  definition, A-72  
INDEX\_TYPE, A-72  
INTERCHANGE\_FORMAT, A-104  
ISIS Software  
  QUBE object, A-80  
ITEM\_BITS, A-8  
ITEM\_BYTES, A-18  
ITEM\_OFFSET, A-8, A-18  
ITEMS, A-8, A-18

**K**

KERNEL\_TYPE  
  table of file extensions, A-96

**L**

line terminators and delimiters  
  vis-a-vis byte counts in objects  
    exclusion of line terminators and delimiters in objects, A-18  
LINE\_DISPLAY\_DIRECTION, A-68  
LINE\_PREFIX\_BYTES, A-67  
LINE\_SAMPLES, A-67  
LINE\_SUFFIX\_BYTES, A-67  
LINES, A-67  
LOGICAL\_VOLUME\_PATH\_NAME, A-133, A-134  
LOGICAL\_VOLUMES, A-133, A-135

**M**

MAXIMUM\_SAMPLING\_PARAMETER, A-88  
MEDIUM\_FORMAT, A-130  
MEDIUM\_TYPE, A-130  
MINIMUM\_SAMPLING\_PARAMETER, A-88

**N**

NAIF Toolkit, A-96  
NAME, A-44

**O**

object definitions  
  URL, A-1  
objects. *See* data object, *See* catalog objects

**P**

PALETTE object, A-81  
definition, A-77  
PDS objects. *See* data objects, *See* catalog objects  
prefix or suffix data  
in QUBE object, A-86  
in TABLE object, A-121, A-125  
primitive data objects, A-1  
primitive objects  
ARRAY, A-4  
BIT\_ELEMENT, A-12  
COLLECTION, A-16  
ELEMENT, A-39  
PRODUCT\_ID, A-97

**Q**

QUBE object  
and HISTORY object, A-81  
definition, A-80

**R**

RECORD\_BYTES, A-111  
RECORD\_TYPE, A-45  
REPETITIONS, A-24  
ROW\_BYTES, A-112  
ROW\_PREFIX\_BYTES, A-67, A-89  
use, A-120  
ROW\_SUFFIX\_BYTES, A-67  
use, A-120

**S**

SAMPLE, A-77  
SAMPLE\_BITS, A-67  
SAMPLE\_DISPLAY\_DIRECTION, A-68  
SAMPLE\_TYPE, A-67  
sampling parameter data  
in SERIES object, A-92  
SAMPLING\_PARAMETER\_INTERVAL, A-88  
SCALING\_FACTOR, A-70  
SEQUENCE\_NUMBER, A-34, A-130  
sequential media, A-34  
SERIES object, A-18, A-111

definition, A-88  
 TIME\_SERIES, A-88  
 SERIES object

use of spare fields  
   , A-125  
 SOFTINFO.TXT, A-126  
 SOURCE\_PRODUCT\_ID, A-96  
 spare bytes, A-121  
 SPARE bytes, A-108  
 spare fields

TABLE object

use of spare fields  
   , A-125  
 use in TABLE, SPECTRUM and SERIES objects, A-125  
 SPECTRUM object, A-18, A-111  
   definition, A-93  
 SPECTRUM object

use of spare fields  
   , A-125  
 SPICE kernels  
   labelling, A-96  
 SPICE system  
   kernel file extensions, A-96  
 SPICE\_KERNEL object  
   definition, A-96  
 SPREADSHEET object  
   CSV file format, A-100  
   definition, A-99  
   example, A-101  
   field delimiters, A-100  
   formats, A-100  
 START\_BYTE, A-4, A-16, A-39, A-105  
 START\_TIME, A-88  
 STOP\_TIME, A-88  
 STRUCTURE pointer, A-109

<b>T</b>
----------

TABLE object, A-18, A-67, A-81  
   and CONTAINER, A-121  
   ASCII field delimiters, A-123  
   ASCII tables, A-105  
   binary tables, A-108

- definition, A-104
- INDEX\_TABLE, A-72
- more than one in a single file, A-117
- PALETTE, A-77
- SERIES object, A-88
- spare bytes, A-121
- SPARE bytes, A-108
- SPECTRUM object, A-93
- stored with IMAGE object, A-120
- STRUCTURE pointer, A-109
- variations, A-111

tables

- multiple tables in single file, A-117

text

- plain text formatting, A-126

TEXT object

- definition, A-126

---

**V**

---

- VICAR headers, A-58
- VOLDESC.CAT, A-13, A-130
- VOLINFO.TXT, A-126
- VOLUME object, A-13, A-30, A-32, A-34, A-44, A-133
  - definition, A-128
- VOLUME\_FORMAT, A-130



# Appendix B. Complete PDS Catalog Object Set

This appendix provides a complete set of the PDS catalog objects. Each section includes a description of the object, lists of keywords and sub-objects, guidelines to follow in assigning values, and a specific example of the object. The catalog objects provide high-level information suitable for loading a database to facilitate searches across data sets, collections and volumes.

The catalog objects included on a PDS volume also provide local, high-level documentation. The full set of catalog objects is required in the CATALOG directory of every PDS archive volume. See the *File Specification and Naming* chapter of this document for pointer and file names used with catalog objects.

Not every object described in this section is required in all cases. A PDS Central Node Data Engineer will supply a set of blank catalog object templates to be completed for any specific delivery, and can also supply additional examples if desired.

## **Description Field Formatting**

The examples in the following sections conform to the current recommendations with respect to format and content. Lines in descriptive text fields (DATA\_SET\_DESC, INSTRUMENT\_DESC, etc.) should not exceed 72 characters, including the <CR><LF> line delimiters. The underlining convention for headings and subheadings provide organization levels for human readers and auto-formatting routines:

<b>Heading</b>	<b>Heading Indent</b>	<b>Text Indent</b>	<b>Underscoring Character</b>
Primary	2 characters	4 characters	=
Secondary	4 characters	6 characters	-

Primary, or main, headings are double-underlined through the use of the equal-sign key (=) which corresponds to ASCII decimal 61. Secondary, or subheadings, are single-underlined through the use of the hyphen key (-) which corresponds to ASCII decimal 45. This underlining convention enhances legibility, and in the future will facilitate the creation of hypertext links.

Also, PDS has adopted a convention for indenting primary headings, secondary headings, and textual descriptions to facilitate readability and to make a better presentation. Primary headings start at Column 3. Text under primary headings and secondary headings starts at Column 5. Text under secondary headings starts at Column 7.

Again for ease of readability, there should be 2 blank lines before the start of a primary or secondary heading. If a secondary heading immediately follows a primary heading, then only 1 blank line should separate the secondary heading from the primary heading.

PDS has developed a Windows based program (FORMAT70) that will automatically format the description fields of any catalog template.

Following is a template layout for a DATA\_SET\_DESC field. This example assumes the keyword DATA\_SET\_DESC itself starts in the first byte.

```

1         2         3         4         5         6         7
123456789012345678901234567890123456789012345678901234567890123456789012
DATA SET_DESC                               = "
(blank line)
(blank line)
    Primary Heading - starts at Column 3
    =====
    Text under headings start at Column 5
    more text starting at Column 5...
(blank line)
(blank line)
    Secondary Heading - starts at Column 5
    -----
    Text under subheadings start at Column 7
    more text starting at Column 7...
(blank line)
(blank line)
    Primary Heading - starts at Column 3
    =====
(blank line)
    Secondary Heading - starts at Column 5
    -----
    Text under subheadings start at Column 7
    more text starting at Column 7...

```

### **Order of Keywords and Sub-Objects**

The examples in the following sections illustrate the preferred ordering for keywords and sub-objects. The order used provides a logical flow that makes the catalog files somewhat easier for a human reader to follow.

## Chapter Contents

Appendix B.	Complete PDS Catalog Object Set.....	B-1
B.1	DATA_SET.....	B-4
B.2	DATA_SET_COLL_ASSOC_DATA_SETS.....	B-10
B.3	DATA_SET_COLLECTION_REF_INFO.....	B-11
B.4	DATA_SET_COLLECTION.....	B-12
B.5	DATA_SET_COLLECTION_INFO.....	B-15
B.6	DATA_SET_HOST.....	B-17
B.7	DATA_SET_INFORMATION.....	B-18
B.8	DATA_SET_MAP_PROJECTION.....	B-21
B.9	DATA_SET_MAP_PROJECTION_INFO.....	B-24
B.10	DATA_SET_REFERENCE_INFORMATION.....	B-26
B.11	DATA_SET_TARGET.....	B-27
B.12	DS_MAP_PROJECTION_REF_INFO.....	B-28
B.13	IMAGE_MAP_PROJECTION.....	B-29
B.14	INSTRUMENT.....	B-34
B.15	INSTRUMENT_HOST.....	B-38
B.16	INSTRUMENT_HOST_INFORMATION.....	B-40
B.17	INSTRUMENT_HOST_REFERENCE_INFO.....	B-41
B.18	INSTRUMENT_INFORMATION.....	B-42
B.19	INSTRUMENT_REFERENCE_INFO.....	B-45
B.20	INVENTORY.....	B-46
B.21	INVENTORY_DATA_SET_INFO.....	B-48
B.22	INVENTORY_NODE_MEDIA_INFO.....	B-49
B.23	MISSION.....	B-50
B.24	MISSION_HOST.....	B-55
B.25	MISSION_INFORMATION.....	B-56
B.26	MISSION_REFERENCE_INFORMATION.....	B-58
B.27	MISSION_TARGET.....	B-59
B.28	PERSONNEL.....	B-60
B.29	PERSONNEL_ELECTRONIC_MAIL.....	B-62
B.30	PERSONNEL_INFORMATION.....	B-63
B.31	REFERENCE.....	B-64
B.32	SOFTWARE.....	B-71
B.33	SOFTWARE_INFORMATION.....	B-73
B.34	SOFTWARE_ONLINE.....	B-74
B.35	SOFTWARE_PURPOSE.....	B-75
B.36	TARGET.....	B-76
B.37	TARGET_INFORMATION.....	B-78
B.38	TARGET_REFERENCE_INFORMATION.....	B-79

## **B.1 DATA\_SET**

The DATA\_SET catalog object is used to submit information about a data set to the PDS. The DATA\_SET object includes a free-form text description of the data set as well as sub-objects for identifying associated targets, hosts, and references.

### **B.1.1 Required Keywords**

1. DATA\_SET\_ID

### **B.1.2 Optional Keywords**

None

### **B.1.3 Required Objects**

1. DATA\_SET\_HOST
2. DATA\_SET\_INFORMATION
3. DATA\_SET\_REFERENCE\_INFORMATION
4. DATA\_SET\_TARGET

### **B.1.4 Optional Objects**

None

### **B.1.5 Usage Notes**

One DATA\_SET\_INFORMATION catalog object must be completed for each data set. One DATA\_SET\_TARGET catalog object must be completed for each target associated with the data set. That is, if there is more than one target, this object is repeated. Similarly, one DATA\_SET\_HOST catalog object must be completed for each host/instrument pair associated with the data set, and one DATA\_SET\_REFERENCE\_INFORMATION catalog object is required for each individual reference associated with the data set. All references should be included that are relevant to providing more detailed / specific data set information; such as, description of the data set, calibration procedures, processing software, data set documentation, review results, etc. These references may include published articles, books, papers, electronic publications, etc.

Note that the DATA\_SET\_TARGET, DATA\_SET\_HOST and DATA\_SET\_REFERENCE objects associate a particular target, host or reference ID with the data set, but do not themselves define the attributes of the corresponding target, host or reference. For each new ID referenced in one of these fields, a high-level description must be provided in the corresponding catalog object. For example, if the REFERENCE\_KEY\_ID listed in a DATA\_SET\_REFERENCE object does not already exist, a new REFERENCE object, defining that REFERENCE\_KEY\_ID, must also be submitted with the delivery. The Central Node data engineers can assist in locating existing catalog objects that may be referenced in any of the above fields.

## B.1.6 Example

```

/* Template: Data Set Template                               Rev: 1993-09-24 */
/*                                                         */
/* Note: Complete one for each data set. Identify multiple targets associated with */
/* the data set by repeating the 3 lines for the DATA_SET_TARGET object.        */
/* Identify multiple hosts associated with the data set by repeating the 4 lines  */
/* for the DATA_SET_HOST object. Identify multiple references associated         */
/* with the data set by repeating the 3 lines of the                               */
/* DATA_SET_REFERENCE_INFORMATION object.                                         */
/*                                                         */
/* Hierarchy:  DATA_SET                                     */
/*             DATA_SET_INFORMATION                       */
/*             DATA_SET_TARGET                           */
/*             DATA_SET_HOST                             */
/*             DATA_SET_REFERENCE_INFORMATION             */
/*                                                         */
PDS_VERSION_ID          = PDS3
LABEL_REVISION_NOTE    = "1998-07-01, Richard Simpson (STANFORD), initial;"
RECORD_TYPE            = STREAM

OBJECT                  = DATA_SET
  DATA_SET_ID          = "MGN-V-RDRS-5-GVDR-V1.0"

  OBJECT                = DATA_SET_INFORMATION
    DATA_SET_NAME      = "MGN V RDRS DERIVED GLOBAL VECTOR DATA RECORD V1.0"
    DATA_SET_COLLECTION_MEMBER_FLG = "N"
    DATA_OBJECT_TYPE   = TABLE
    START_TIME          = 1990-08-01T00:00:00
    STOP_TIME           = 1993-12-31T23:59:59
    DATA_SET_RELEASE_DATE = 1994-07-01
    PRODUCER_FULL_NAME  = "MICHAEL J. MAURER"
    DETAILED_CATALOG_FLAG = "N"
    DATA_SET_TERSE_DESC = "The Global Vector Data Record (GVDR)
                           is a sorted collection of scattering and
                           emission measurements from the Magellan
                           Mission"

    CITATION_DESC       = "Maurer, M.J., MGN V RDRS DERIVED GLOBAL VECTOR
                           DATA RECORD V1.0, MGN-V-RDRS-5-GVDR-V1.0, NASA
                           Planetary Data System, 1994."

    DATA_SET_DESC      = "

Data Set Overview
=====
The Global Vector Data Record (GVDR) is a sorted collection of scattering and emission
measurements from the Magellan Mission. The sorting is into a grid of equal area 'pixels'
distributed regularly about the planet. For data acquired from the same pixel but in
different observing geometries, there is a second level of sorting to accommodate the
different geometrical conditions. The 'pixel' dimension is 18.225 km. The GVDR is presented
in Sinusoidal Equal Area (equatorial), Mercator (equatorial), and Polar Stereographic (polar)
projections.

The GVDR is intended to be the most systematic and comprehensive representation of the
electromagnetic properties of the Venus surface that can be derived from Magellan data at
this resolution. It should be useful in characterizing and comparing distinguishable surface
units.

Parameters
=====

```

The Magellan data set comprises three basic data types: echoes from the nadir-viewing altimeter (ALT), echoes from the oblique backscatter synthetic aperture radar (SAR) imaging system, and passive radio thermal emission measurements made using the SAR equipment. The objective in compiling the GVDR is to obtain an accurate estimate of the surface backscattering function (sometimes called the specific backscatter function or 'sigma-zero') for Venus from these three data types and to show its variation with incidence (polar) angle, azimuthal angle, and surface location.

The ALT data set has been analyzed to yield profiles of surface elevation [FORD&PETTENGILL1992] and estimates of surface Fresnel reflectivity and estimates of meter-scale rms surface tilts by at least two independent methods [FORD&PETTENGILL1992;TYLER1992]. The 'inversion' approach of [TYLER1992] provides, in addition, an empirical estimate of the surface backscatter function at incidence angles from nadir to as much as 10 degrees from nadir in steps of 0.5 degrees.

Statistical analysis of SAR image pixels for surface regions about 20 km (across track) by 2 km (along track) provided estimates of the surface backscatter function over narrow angular ranges (1-4 degrees) between 15 and 50 degrees from normal incidence [TYLER1992]. By combining results from several orbital passes over the same region in different observing geometries, the backscatter response over the full oblique angular range (15-50) could be compiled. In fact, the number of independent observing geometries attempted with Magellan was limited, and some of these represented changes in azimuth rather than changes in incidence (or polar) angle. Nevertheless, data from many regions were collected in more than one SAR observing geometry. Histograms of pixel values and quadratic fits to the surface backscattering function over narrow ranges of incidence angle were computed by [TYLER1992].

Passive microwave emission by the surface of Venus was measured by the Magellan radar receiver between ALT and SAR bursts. These measurements have been converted to estimates of surface emissivity [PETTENGILLETAL1992]. With certain assumptions the emissivity derived from these data should be the complement of the Fresnel reflectivity derived from the ALT echo strengths. In cases where the two quantities do not add to unity, the assumptions about a simple dielectric (Fresnel) interface at the surface of Venus must be adjusted.

#### Processing

=====

The processing carried out at the Massachusetts Institute of Technology (MIT) to obtain altimetry profiles and estimates of Fresnel reflectivity and rms surface tilts has been described elsewhere [FORD&PETTENGILL1992]. In brief it involves fitting pre-computed templates to measured echo profiles; the topographic profiles, Fresnel reflectivities, and rms surface tilts are chosen to minimize differences between the data and templates in a least-squares sense. The estimates of emissivity require calibration of the raw data values and correction for attenuation and emission by the Venus atmosphere [PETTENGILLETAL1992]. These data have been collected by orbit number on a set of compact discs [FORD1992] and into a set of global maps, also distributed on compact disc [FORD1993].

At Stanford ALT-EDR tapes were the input for calculation of near-nadir empirical backscattering functions. For oblique backscatter, C-BIDR tapes from the Magellan Project and F-BIDR files obtained via Internet from Washington University were the input products. Output was collected on an orbit-by-orbit basis into a product known as the Surface Characteristics Vector Data Record (SCVDR). The SCVDR has been delivered to the Magellan Project for orbits through 2599; processing of data beginning with orbit 2600 and continuing through the end-of-Mission is pending completion of the first version of the GVDR.

#### Data

====

The GVDR data set comprises several 'tables' of results based on analysis of each of the data types described above. These include:

- (1) Image Data Table
- (2) Radiometry Data Table
- (3) MIT ALT Data Table
- (4) Stanford ALT Data Table

- (1) Image Data Table

This table contains results from analysis of SAR image strips. The results are parameterized by the azimuth angle, the incidence (polar) angle, and the polarization angle. Quantities include the number of image frame lets used to compute the scattering parameters; the median, the mode, and the one-standard-deviation limits of the pixel histogram; and the three coefficients and the reference angle of the quadratic approximation to sigma-zero as a function of incidence angle.

- (2) Radiometry Data Table

This table contains results from MIT analysis of the radiometry data. The results are parameterized by the azimuth angle, the incidence angle, and the polarization angle. The results include the number of radiometry footprints used to compute the estimate of thermal emissivity, the emissivity, and its variance.

## (3) MIT ALT Data Table

This table contains results derived from the MIT altimetry data analysis. The results include the number of ARCDR ADF footprints used in computing the estimates of scattering properties for the pixel and estimates (and variances) of radius, rms surface tilt, and Fresnel reflectivity from the ARCDR.

## (4) Stanford ALT Data Table

This table contains results from the Stanford analysis of altimetry data. Results include the number of SCVDR footprints used in computing the estimates of surface properties for this pixel, the centroid of the Doppler spectrum, the derived scattering function and the angles over which it is valid, variance of the individual points in the derived scattering function, and results of fitting analytic functions to the derived scattering function.

## Ancillary Data

=====

Ancillary data for most processing at both MIT and Stanford was obtained from the data tapes and files received from the Magellan Project. These included trajectory and pointing information for the spacecraft, clock conversion tables, spacecraft engineering data, and SAR processing parameters. For calibration of the radar instrument itself, Magellan Project reports (including some received from Hughes Aircraft Co.[BARRY1987; CUEVAS1989; SE011]) were used. Documentation on handling of data at the Jet Propulsion Laboratory was also used [BRILL&MEISL1990; SCIEDR; SDPS101].

## Coordinate System

=====

The data are presented in gridded formats, tiled to ensure that closely spaced points on the surface occupy nearby storage locations on the data storage medium. Four separate projections are used: sinusoidal equal area and Mercator for points within 89 degrees of the equator, and polar stereographic for points near the north and south poles. The projections are described by [SNYDER1987]; IAU conventions described by [DAVIESETAL1989] and Magellan Project assumptions [LYONS1988] have been adopted.

## Software

=====

A special library and several example programs are provided in source code form for reading the GVDR data files. The general-purpose example program will serve the needs of the casual user by accessing a given GVDR quantity over a specified region of GVDR pixels. More advanced users may want to write their own programs that use the GVDR library as a toolkit. The library, written in ANSI C, provides concise access methods for reading every quantity stored in the GVDR. It conveniently handles all geometric and tiling transformations and converts any compressed quantities to a standard native format. The general purpose program mentioned above provides an example of how to use this library.

## Media/Format

=====

The GVDR will be delivered to the Magellan Project (or its successor) using compact disc write once (CD-WO) media. Formats will be based on standards for such products established by the Planetary Data System (PDS) [PDSSR1992]."

CONFIDENCE\_LEVEL\_NOTE = "

## Confidence Level Overview

=====

The GVDR is intended to be the most systematic and comprehensive representation of the electromagnetic properties of the Venus surface that can be derived from Magellan data at this resolution. Nevertheless, there are limitations to what can be done with the data.

## Review

=====

The GVDR will be reviewed internally by the Magellan Project prior to release to the planetary community. The GVDR will also be reviewed by PDS.

## Data Coverage and Quality

=====

Because the orbit of Magellan was elliptical during most of its mapping operations, parts of the orbital coverage have higher resolution and higher signal-to-noise than others.

## Cycle 1 Mapping

-----

During Mapping Cycle 1, periapsis was near 10 degrees N latitude at altitudes of approximately 300 km over the surface. The altitude near the poles, on the other hand, was on the order of 3000 km. For all data types this means lower confidence in the results obtained at the poles than near the equator.

Further, the spacecraft attitude was adjusted so that the SAR antenna was pointed at about 45 degrees from nadir near periapsis; this was reduced to near 15 degrees at the poles. The objective was to compensate somewhat for the changing elevation and to provide scattering at higher incidence angles when the echo signal was expected to be strongest. The ALT antenna, at a constant 25 degree offset from the SAR antenna, followed in tandem but at angles which were not optimized for obtaining the best altimetry echo.

During Mapping Cycle 1 almost half the orbits provided SAR images of the north pole; because of the orbit inclination, ALT data never extended beyond about 85N latitude in the north and 85S in the south. No SAR images of the south pole were acquired during Mapping Cycle 1 because the SAR antenna was always pointed to the left of the ground track; the Cycle 1 SAR image strip near the south pole was at a latitude equator ward of 85S.

#### Cycle 2 Mapping

During much of Mapping Cycle 2, the spacecraft was flown 'backwards' so as to provide SAR images of the same terrain but with 'opposite side' illumination. This adjustment also meant that the SAR could image near the Venus south pole (but not near the north pole). The ALT data continued to be limited to latitudes equator ward of 85N and 85S.

#### Cycle 3 Mapping

During Mapping Cycle 3 the emphasis was on obtaining SAR data from the same side as in Cycle 1 but at different incidence angles (for radar stereo). In fact, most data were acquired at an incidence angle of about 25 degrees, which meant that the ALT antenna was usually aimed directly at nadir instead of drifting from side to side, as had been the case in Cycle 1. These Cycle 3 data, therefore, may be among the best from the altimeter. Dynamic range in SAR data was larger than in Cycle 1 because the incidence angle was fixed rather than varying to compensate for the changing spacecraft height.

#### All Cycles

It is important to remember that, since the SAR and ALT antennas were aimed at different parts of the planet during each orbit, building up a collection of composite scattering data for any single surface region requires that results from several orbits be integrated. In the case of data from polar regions, where only the SAR was able to probe, there will be no ALT data. When scheduling or other factors interrupted the systematic collection of data, there may be ALT data for some regions but no comparable SAR or radiometry data (or viceversa).

Note that for all Cycles outages played an important role in determining coverage. For example, although a goal of Cycle 3 radar mapping was radar stereo, early orbits were used to collect data at nominal incidence angles that had been missed during Cycle 1 because of thermal problems with the spacecraft. A transmitter failure during Cycle 3 caused a loss of further data. It is not within the scope of this description to provide detailed information on data coverage.

#### Limitations

Both the template fitting approach and the inversion approach will have their limitations in estimating overall surface properties for a region on Venus. The template calculation assumes that scattering is well-behaved at all incidence angles from 0 to 90 degrees and that a template representing that behavior can be constructed. The Hagfors function [HAGFORS1964] used by MIT, however, fails to give a finite rms surface tilt if used over this range of angles, so approximations based on a change in the scattering mechanism must be applied [HAGFORS&EVANS1968]. The inversion method [TYLER1992] is susceptible to noise at the higher incidence angles and this will corrupt solutions if not handled properly. Users of this data set should be aware that radar echoes are statistically variable and that each result has an uncertainty.

A nominal nadir footprint can be assigned to altimetry results, but this footprint is biased near periapsis because the ALT antenna is rotated about 20 degrees from nadir (during Cycle 1). Over polar regions in Cycle 1, the ALT antenna is rotated about 10 degrees to the opposite side of nadir. A more important consideration in polar regions is that the area illuminated by the ALT antenna is approximately 100 times as large as near periapsis because of the higher spacecraft altitude. The region contributing to echoes in polar regions -- and therefore the region over which estimates of Fresnel reflectivity and rms surface tilts apply -- is much larger than at periapsis."

```

END_OBJECT          = DATA_SET_INFORMATION
OBJECT              = DATA_SET_TARGET
  TARGET_NAME       = VENUS
END_OBJECT          = DATA_SET_TARGET

OBJECT              = DATA_SET_HOST
  INSTRUMENT_HOST_ID = MGN
  INSTRUMENT_ID      = RDRS

```



```

END_OBJECT                = DATA_SET_HOST

OBJECT
  REFERENCE_KEY_ID        = DATA_SET_REFERENCE_INFORMATION
END_OBJECT                = "BARRY1987"
                           = DATA_SET_REFERENCE_INFORMATION

OBJECT
  REFERENCE_KEY_ID        = DATA_SET_REFERENCE_INFORMATION
END_OBJECT                = "BRILL&MEISL1990"
                           = DATA_SET_REFERENCE_INFORMATION

OBJECT
  REFERENCE_KEY_ID        = DATA_SET_REFERENCE_INFORMATION
END_OBJECT                = "CUEVAS1989"
                           = DATA_SET_REFERENCE_INFORMATION

OBJECT
  REFERENCE_KEY_ID        = DATA_SET_REFERENCE_INFORMATION
END_OBJECT                = "DAVISETAL1989"
                           = DATA_SET_REFERENCE_INFORMATION

OBJECT
  REFERENCE_KEY_ID        = DATA_SET_REFERENCE_INFORMATION
END_OBJECT                = "FORD1992"
                           = DATA_SET_REFERENCE_INFORMATION

OBJECT
  REFERENCE_KEY_ID        = DATA_SET_REFERENCE_INFORMATION
END_OBJECT                = "FORD1993"
                           = DATA_SET_REFERENCE_INFORMATION

OBJECT
  REFERENCE_KEY_ID        = DATA_SET_REFERENCE_INFORMATION
END_OBJECT                = "FORD&PETTENGILL1992"
                           = DATA_SET_REFERENCE_INFORMATION

OBJECT
  REFERENCE_KEY_ID        = DATA_SET_REFERENCE_INFORMATION
END_OBJECT                = "HAGFORS1964"
                           = DATA_SET_REFERENCE_INFORMATION

OBJECT
  REFERENCE_KEY_ID        = DATA_SET_REFERENCE_INFORMATION
END_OBJECT                = "HAGFORS&EVANS1968"
                           = DATA_SET_REFERENCE_INFORMATION

OBJECT
  REFERENCE_KEY_ID        = DATA_SET_REFERENCE_INFORMATION
END_OBJECT                = "LYONS1988"
                           = DATA_SET_REFERENCE_INFORMATION

OBJECT
  REFERENCE_KEY_ID        = DATA_SET_REFERENCE_INFORMATION
END_OBJECT                = "PDSSR1992"
                           = DATA_SET_REFERENCE_INFORMATION

OBJECT
  REFERENCE_KEY_ID        = DATA_SET_REFERENCE_INFORMATION
END_OBJECT                = "PETTENGILLETAL1992"
                           = DATA_SET_REFERENCE_INFORMATION

OBJECT
  REFERENCE_KEY_ID        = DATA_SET_REFERENCE_INFORMATION
END_OBJECT                = "SCIEDR"
                           = DATA_SET_REFERENCE_INFORMATION

OBJECT
  REFERENCE_KEY_ID        = DATA_SET_REFERENCE_INFORMATION
END_OBJECT                = "SDPS101"
                           = DATA_SET_REFERENCE_INFORMATION

OBJECT
  REFERENCE_KEY_ID        = DATA_SET_REFERENCE_INFORMATION
END_OBJECT                = "SE011"
                           = DATA_SET_REFERENCE_INFORMATION

OBJECT
  REFERENCE_KEY_ID        = DATA_SET_REFERENCE_INFORMATION
END_OBJECT                = "SNYDER1987"
                           = DATA_SET_REFERENCE_INFORMATION

OBJECT
  REFERENCE_KEY_ID        = DATA_SET_REFERENCE_INFORMATION
END_OBJECT                = "TYLER1992"
                           = DATA_SET_REFERENCE_INFORMATION

END_OBJECT                = DATA_SET
END

```

## **B.2 DATA\_SET\_COLL\_ASSOC\_DATA\_SETS**

The DATA\_SET\_COLL\_ASSOC\_DATA\_SETS catalog object, a sub-object of the DATA\_SET\_COLLECTION object, is repeated for each data set associated with a DATA\_SET\_COLLECTION. For example, if there are three distinct data sets comprising a collection, this object will be repeated three different times – once for each data set.

### **B.2.1 Required Keywords**

1. DATA\_SET\_ID

### **B.2.2 Optional Keywords**

None

### **B.2.3 Required Objects**

None

### **B.2.4 Optional Objects**

None

### **B.2.5 Example**

See the example of the DATA\_SET\_COLLECTION object in Section B.4.5.

## **B.3 DATA\_SET\_COLLECTION\_REF\_INFO**

The DATA\_SET\_COLLECTION\_REF\_INFO catalog object, a sub-object of DATA\_SET\_COLLECTION object, associates a reference with a data set collection. It is repeated once for each reference identified in the DATA\_SET\_COLLECTION catalog object.

A separate REFERENCE catalog object must be completed to provide the associated citation for each reference.

### **B.3.1 Required Keywords**

#### 1. REFERENCE\_KEY\_ID

Note: If there are no relevant references to cite, the REFERENCE\_KEY\_ID should have a value of "N/A".

### **B.3.2 Optional Keywords**

None

### **B.3.3 Required Objects**

None

### **B.3.4 Optional Objects**

None

### **B.3.5 Example**

See the example for the DATA\_SET\_COLLECTION object in Section B.4.5.

## **B.4 DATA\_SET\_COLLECTION**

The DATA\_SET\_COLLECTION catalog object is used to link several data sets as a collection to be used and distributed together.

### **B.4.1 Required Keywords**

1. DATA\_SET\_COLLECTION\_ID

### **B.4.2 Optional Keywords**

None

### **B.4.3 Required Objects**

1. DATA\_SET\_COLL\_ASSOC\_DATA\_SETS
2. DATA\_SET\_COLLECTION\_INFO
3. DATA\_SET\_COLLECTION\_REF\_INFO

### **B.4.4 Optional Objects**

None

### **B.4.5 Usage Notes**

One DATA\_SET\_COLLECTION\_INFORMATION catalog object must be completed for each data set collection. One DATA\_SET\_COLLECTION\_ASSOC\_DATA\_SETS catalog object must be completed for each data set associated with the data set collection. That is, if there is more than one data set, this object is repeated. Similarly, one DATA\_SET\_COLLECTION\_REF\_INFO catalog object is required for each individual reference associated with the data set collection. All references should be included that are relevant to providing more detailed / specific data set collection information; such as, description of the data set collection. These references may include published articles, books, papers, electronic publications, etc.

## B.4.6 Example:

```

/* Template: Data Set Collection Template                               Rev: 1993-09-24          */
/* Note: Complete one template for each data set collection. Identify */
/* individual data sets that are included in the collection by       */
/* repeating the 3 lines for the DATA_SET_COLL_ASSOC_DATA_SETS     */
/* object. Identify each data set collection reference by           */
/* repeating the 3 lines for the DATA_SET_COLLECTION_REF_INFO object. */
/* Also complete a separate REFERENCE template for each new        */
/* reference submitted to PDS.                                       */

/* Hierarchy:  DATA_SET_COLLECTION                                 */
/*             DATA_SET_COLLECTION_INFO                          */
/*             DATA_SET_COLL_ASSOC_DATA_SETS                    */
/*             DATA_SET_COLLECTION_REF_INFO                       */

```

```

OBJECT          = DATA_SET_COLLECTION
  DATA_SET_COLLECTION_ID = "PREMGN-E/L/H/M/V-4/5-RAD/GRAV-V1.0"

OBJECT          = DATA_SET_COLLECTION_INFO
  DATA_SET_COLLECTION_NAME = "PRE-MGN E/L/H/M/V 4/5 RADAR/GRAVITY DATA V1.0"
  DATA_SETS              = 15
  START_TIME              = 1968-11-09T00:00:00
  STOP_TIME                = 1988-07-27T00:00:00
  DATA_SET_COLLECTION_RELEASE_DT = 1990-06-15
  PRODUCER_FULL_NAME      = "RAYMOND E. ARVIDSON"
  DATA_SET_COLLECTION_DESC = "

```

### Data Set Collection Overview

This entity is a collection of selected Earth-based radar data of Venus, the Moon, Mercury, and Mars, Pioneer Venus radar data, airborne radar images of Earth, and line of sight acceleration data derived from tracking the Pioneer Venus Orbiter and Viking Orbiter 2. Included are 12.6 centimeter wavelength Arecibo Venus radar images, 12.6 to 12.9cm Goldstone Venus radar images and altimetry data, together with altimetry, brightness temperature, Fresnel reflectivity and rms slopes derived from the Pioneer Venus Radar Mapper. For the Moon, Haystack 3.8 centimeter radar images and Arecibo 12.6 and 70 centimeter radar images are included. Mars data include Goldstone altimetry data acquired between 1971 and 1982 and araster data set containing radar units that model Goldstone and Arecibo backscatter observations. Mercury data consist of Goldstone altimetry files. The terrestrial data were acquired over the Pisgah lava flows and the Kelso dune field in the Mojave Desert, California, and consist of multiple frequency, multiple incidence angle views of the same regions. Data set documentation is provided, with references that allow the reader to reconstruct processing histories. The entire data set collection and documentation are available on a CD-ROM entitled Pre-Magellan Radar and Gravity Data."

```
DATA_SET_COLLECTION_USAGE_DESC = "
```

### Data Set Collection Usage Overview

The intent of the data set collection is to provide the planetary science community with radar and gravity data similar to the kinds of data that Magellan will begin collecting in the summer of 1990. The data set collection will be used for pre-Magellan analyses of Venus and for comparisons to actual Magellan data. The entire data set collection and documentation are available on a CD-ROM entitled Pre-Magellan Radar and Gravity Data. A list of the hardware and software that may be used to read this CD-ROM can be obtained from the PDS Geosciences Discipline Node."

```

END_OBJECT          = DATA_SET_COLLECTION_INFO

OBJECT              = DATA_SET_COLL_ASSOC_DATA_SETS
  DATA_SET_ID      = "NDC8-E-ASAR-4-RADAR-V1.0"
END_OBJECT          = DATA_SET_COLL_ASSOC_DATA_SETS

OBJECT              = DATA_SET_COLL_ASSOC_DATA_SETS
  DATA_SET_ID      = "ARCB-L-RTLS-5-12.6CM-V1.0"
END_OBJECT          = DATA_SET_COLL_ASSOC_DATA_SETS

OBJECT              = DATA_SET_COLL_ASSOC_DATA_SETS
  DATA_SET_ID      = "ARCB-L-RTLS-4-70CM-V1.0"
END_OBJECT          = DATA_SET_COLL_ASSOC_DATA_SETS

OBJECT              = DATA_SET_COLL_ASSOC_DATA_SETS
  DATA_SET_ID      = "ARCB-V-RTLS-4-12.6CM-V1.0"
END_OBJECT          = DATA_SET_COLL_ASSOC_DATA_SETS

```



## **B.5 DATA\_SET\_COLLECTION\_INFO**

The DATA\_SET\_COLLECTION\_INFO catalog object, a sub-object of DATA\_SET\_COLLECTION, provides an overview of content and usage, as well as other information specific to the data set collection. This object includes a free-form text description, DATA\_SET\_COLLECTION\_DESC.

### **B.5.1 Required Keywords**

1. DATA\_SET\_COLLECTION\_DESC
2. DATA\_SET\_COLLECTION\_NAME
3. DATA\_SET\_COLLECTION\_RELEASE\_DT
4. DATA\_SET\_COLLECTION\_USAGE\_DESC
5. DATA\_SETS
6. PRODUCER\_FULL\_NAME
7. START\_TIME
8. STOP\_TIME

### **B.5.2 Optional Keywords**

None

### **B.5.3 Required Objects**

None

### **B.5.4 Optional Objects**

None

### **B.5.5 Usage Notes**

NOTE: The following paragraph headings and subheadings are recommended as the minimum set of headings needed to describe a data set collection adequately. Additional headings and subheadings may be added as desired. Should any of the more common headings *not* appear within a text description, it will be considered not applicable to the data set collection.

### **B.5.5.1 DATA\_SET\_COLLECTION\_INFO Headings**

#### Data Set Collection Overview

A high-level description of the characteristics and properties of a data set collection

#### Data Set Collection Usage Overview

A high-level description of the intended use of a data set collection

### **B.5.6 Example**

See the example of the DATA\_SET\_COLLECTION object in Section B.4.5.



## **B.6 DATA\_SET\_HOST**

The DATA\_SET\_HOST catalog object, a sub-object of the DATA\_SET catalog object, identifies one host/instrument pair associated with a data set.

### **B.6.1 Required Keywords**

1. INSTRUMENT\_HOST\_ID
2. INSTRUMENT\_ID

### **B.6.2 Optional Keywords**

None

### **B.6.3 Required Objects**

None

### **B.6.4 Optional Objects**

None

### **B.6.5 Example**

See the example for the DATA\_SET object in Section B.1.6

## **B.7**

## **B.7 DATA\_SET\_INFORMATION**

The DATA\_SET\_INFORMATION catalog object, a sub-object of the DATA\_SET catalog object, provides a high-level description of a single PDS data set.

### **B.7.1 Required Keywords**

1. CITATION\_DESC
2. CONFIDENCE\_LEVEL\_NOTE
3. DATA\_OBJECT\_TYPE
4. DATA\_SET\_COLLECTION\_MEMBER\_FLG
5. DATA\_SET\_TERSE\_DESC
6. DATA\_SET\_DESC
7. DATA\_SET\_NAME
8. DATA\_SET\_RELEASE\_DATE
9. DETAILED\_CATALOG\_FLAG
10. PRODUCER\_FULL\_NAME
11. START\_TIME
12. STOP\_TIME

### **B.7.2 Optional keywords**

None

### **B.7.3 Required Objects**

None

### **B.7.4 Optional Objects**

None

### **B.7.5 Usage Notes**

The DATA\_SET\_INFORMATION catalog object includes two free-form text description fields: DATA\_SET\_DESC and CONFIDENCE\_LEVEL\_NOTE. Following are recommended headings and subheadings for use in these fields, with brief descriptions of suggested contents.

**Note:** These headings and subheadings are recommended as the minimum set of headings needed to describe a data set adequately. Additional headings and sub-headings may be added as desired. Should any of the more common headings *not* appear within the description, they will be assumed to be not applicable to the data set.

### **B.7.5.1 DATA\_SET\_DESC Headings**

#### Data Set Overview

A high level description of the characteristics and properties of a data set

#### Parameters

The primary parameters (measured or derived quantities) included in the data set, with units and sampling intervals

#### Processing

The overall processing used to produce the data set, including a description of the input data (and source), processing methods or software, and primary parameters or assumptions used to produce the data set

#### Data

Detailed description of each data type identified in the “Data Set Overview”, (e.g., image data, table data, etc.)

#### Ancillary Data

Description of the ancillary information needed to interpret the data set. The ancillary information may or may not be provided along with the data set. If not, this description should include sources or references for locating the ancillary data.

#### Coordinate System

Description of the coordinate system(s) or frame(s) of reference to be used for proper interpretation of the data set

#### Software

Description of software relevant to the data, including software supplied with the data set as well as external software or systems that may be accessed independently to assist in visualization or analysis of the data

#### Media/Format

Description of the media on which the data set is delivered to PDS for distribution, including format information that may limit use of the data set on specific hardware platforms (e.g., binary/ASCII, IBM EBCDIC format)

### **B.7.5.2 CONFIDENCE\_LEVEL\_NOTE Headings**

#### Confidence Level Overview

A high level description of the level of confidence (e.g., reliability, accuracy, or certainty) in the data

#### Review

Brief description of the review process that took place prior to release of the data set to insure the accuracy and completeness of the data and associated documentation

#### Data Coverage and Quality

Description of overall data coverage and quality. This section should include information about gaps in the data (both for times or regions) and details regarding how missing or poor data are flagged or filled, if applicable.

#### Limitations

Description of any limitations on the use of the data set. For example, discuss other data required to interpret the data properly, or any assumptions regarding special processing systems used to further reduce or analyze the data. If the data have been calibrated or otherwise corrected or derived, describe any known anomalies or uncertainties in the results.

### **B.7.5.3 CITATION\_DESC Formation Rule**

The CITATION\_DESC keyword is subject to a formation rule described in detail in the CITATION\_DESC element definition in the PDS Data Dictionary. A brief description is:

{ <author\_name>, <author\_name>, ... }, <data\_set\_name>, DATA\_SET\_ID,  
NASA Planetary Data System, <year\_of\_peer\_review>.

If a citation description is not defined, nor is applicable to the data set, the value "N/A" should be used.

### **B.7.5.4 OTHER - Data Supplier provided**

Any other important information in addition to the headings above, as desired (e.g., data compression, time-tagging, etc.)

### **B.7.6 Example**

See the example for the DATA\_SET object in Section B.1.6.

## B.8 DATA\_SET\_MAP\_PROJECTION

The DATA\_SET\_MAP\_PROJECTION catalog object is one of two distinct objects that together define the map projection used in creating the digital images in a PDS data set. The associated object that completes the definition is the IMAGE\_MAP\_PROJECTION, which is fully described in Appendix B.13 of this document.

The map projection information resides in these two objects essentially to reduce data redundancy and at the same time allow the inclusion of elements needed to process the data at the image level. Static information that is applicable to the complete data set resides in the DATA\_SET\_MAP\_PROJECTION object while dynamic information that is applicable to the individual images resides in the IMAGE\_MAP\_PROJECTION object.

### B.8.1 Required Keywords

1. DATA\_SET\_ID

### B.8.2 Optional Keywords

None

### B.8.3 Required Objects

1. DATA\_SET\_MAP\_PROJECTION\_INFO

### B.8.4 Optional Objects

None

### B.8.5 Example

```

PDS_VERSION_ID          = PDS3
LABEL_REVISION_NOTE    = "1998-07-01, Richard Simpson (STANFORD), initial;"
RECORD_TYPE            = FIXED_LENGTH
RECORD_BYTES           = 80

SPACECRAFT_NAME        = MAGELLAN
TARGET_NAME            = VENUS

OBJECT
  DATA_SET_ID          = DATA_SET_MAP_PROJECTION
                       = "MGN-V-RDRS-5-DIM-V1.0"

  OBJECT
    MAP_PROJECTION_TYPE = DATA_SET_MAP_PROJECTION_INFO
                       = "SINUSOIDAL"

```

```
MAP_PROJECTION_DESC = "
```

#### Map Projection Overview

```
=====
```

The FMAP (Magellan Full Resolution Radar Mosaic) is presented in a Sinusoidal Equal-Area map projection. In this projection, parallels of latitude are straight lines, with constant distances between equal latitude intervals. Lines of constant longitude on either side of the projection meridian are curved since longitude intervals decrease with the cosine of latitude to account for their convergence toward the poles. This projection offers a number of advantages for storing and managing global digital data; in particular, it is computationally simple, and data are stored in a compact form.

The Sinusoidal Equal-Area projection is characterized by a projection longitude, which is the center meridian of the projection, and a scale, which is given in units of pixels/degree. The center latitude for all FMAP's is the equator. Each FMAP contains its own central meridian. The tiles that make up an FMAP all have the same central meridian as the FMAP.

#### Lat/Lon, Line/Sample Transformations

```
-----
```

The transformation from latitude and longitude to line and sample is given by the following equations:

```
line = INT(LINE_PROJECTION_OFFSET - lat*MAP_RESOLUTION + 1.0)
```

```
sample = INT(SAMPLE_PROJECTION_OFFSET - (lon -
          CENTER_LONGITUDE)*MAP_RESOLUTION*cos(lat) + 1.0)
```

Note that integral values of line and sample correspond to center of a pixel. Lat and lon are the latitude and longitude of a given spot on the surface.

#### Line Projection Offset

```
-----
```

LINE\_PROJECTION\_OFFSET is the line number minus one on which the map projection origin occurs. The map projection origin is the intersection of the equator and the projection longitude. The value of LINE\_PROJECTION\_OFFSET is positive for images starting north of the equator and is negative for images starting south of the equator.

#### Sample Projection Offset

```
-----
```

SAMPLE\_PROJECTION\_OFFSET is the nearest sample number to the left of the projection longitude. The value of SAMPLE\_PROJECTION\_OFFSET is positive for images starting to the west of the projection longitude and is negative for images starting to the east of the projection longitude.

#### Center Longitude

```
-----
```

CENTER\_LONGITUDE is the value of the projection longitude, which is the longitude that passes through the center of the projection.

The values for FMAP products will be 1408, 235, and 35.

There are four PDS parameters that specify the latitude and longitude boundaries of an image. MAXIMUM LATITUDE and MINIMUM LATITUDE specify the latitude boundaries of the image, and EASTERNMOST\_LONGITUDE and WESTERNMOST\_LONGITUDE specify the longitudinal boundaries of the map.

Definitions of other mapping parameters can be found in the Planetary Science Data Dictionary."

```
ROTATIONAL_ELEMENT_DESC = "See DAVIESETAL1989."
```

```
OBJECT = DS_MAP_PROJECTION_REF_INFO
REFERENCE_KEY_ID = "DAVIESETAL1989"
END_OBJECT = DS_MAP_PROJECTION_REF_INFO
```

```
OBJECT = DS_MAP_PROJECTION_REF_INFO
REFERENCE_KEY_ID = "BATSON1987"
END_OBJECT = DS_MAP_PROJECTION_REF_INFO
```

```
OBJECT = DS_MAP_PROJECTION_REF_INFO
REFERENCE_KEY_ID = "EDWARDS1987"
END_OBJECT = DS_MAP_PROJECTION_REF_INFO
```

```
END_OBJECT = DATA_SET_MAP_PROJECTION_INFO
END_OBJECT = DATA_SET_MAP_PROJECTION
```

```
END
```

## **B.9 DATA\_SET\_MAP\_PROJECTION\_INFO**

The DATA\_SET\_MAP\_PROJECTION catalog object, a sub-object of DATA\_SET\_MAP\_PROJECTION, defines the specific map projection of an image data set.

### **B.9.1 Required Keywords**

1. MAP\_PROJECTION\_DESC
2. MAP\_PROJECTION\_TYPE
3. ROTATIONAL\_ELEMENT\_DESC

### **B.9.2 Optional Keywords**

None

### **B.9.3 Required Objects**

1. DS\_MAP\_PROJECTION\_REF\_INFO

### **B.9.4 Optional Objects**

None

### **B.9.5 Usage notes**

The MAP\_PROJECTION\_DESC text should contain at least one heading, “Map Projection Overview”. This section should provide a description of the map projection of the data set, indicating mathematical expressions used for latitude/longitude or line/sample transformations, line and sample projection offsets, center longitudes, etc., as well as any assumptions made in processing. Subheadings may be used for each of these descriptions, if desired.

The ROTATIONAL\_ELEMENT\_DESC text should contain at least one heading, “Rotational Element Overview”. This section should provide a description of the standard used for the definition of a planet’s pole orientation and prime meridian, right ascension and declination, spin angle, etc. (Please see the *Planetary Science Data Dictionary* for complete description.) The value in this field may also be a bibliographic citation of a published work containing the rotation element description. In this case the “Rotational Element Overview” heading may be omitted.

An example of a DATA\_SET\_MAP\_PROJECTION\_INFO object may be found in the previous section detailing the DATA\_SET\_MAP\_PROJECTION object.

**Example**

See the example for the DATA\_SET\_MAP\_PROJECTION object in Section B.8.5.



## **B.10 DATA\_SET\_REFERENCE\_INFORMATION**

The DATA\_SET\_REFERENCE\_INFORMATION object, a sub-object of DATA\_SET catalog object, is used to identify references relevant to a particular data set. . A separate object must be completed for each reference cited within the DATA\_SET catalog object.

A separate REFERENCE catalog object is completed to provide the associated citation for each reference.

### **B.10.1 Required Keywords**

#### 1. REFERENCE\_KEY\_ID

Note: If there are no relevant references to cite, the REFERENCE\_KEY\_ID should have a value of "N/A".

### **B.10.2 Optional Keywords**

None

### **B.10.3 Required Objects**

None

### **B.10.4 Optional Objects**

None

### **B.10.5 Example**

See the example for the DATA\_SET object in Section B.1.6.

## **B.11 DATA\_SET\_TARGET**

The DATA\_SET\_TARGET object, a sub-object of DATA\_SET catalog object, identifies an observed target.

### **B.11.1 Required Keywords**

1. TARGET\_NAME

### **B.11.2 Optional Keywords**

None

### **B.11.3 Required Objects**

None

### **B.11.4 Optional Objects**

None

### **B.11.5 Example**

See the example for the DATA\_SET object in Section B.1.6.

## **B.12 DS\_MAP\_PROJECTION\_REF\_INFO**

The DS\_MAP\_PROJECTION\_REF\_INFO object, a sub-object of DATA\_SET\_MAP\_PROJECTION\_INFO catalog object, is used to identify references relevant to a map projection. A separate object must be completed for each reference cited within the DATA\_SET\_MAP\_PROJECTION\_INFO catalog object.

A separate REFERENCE catalog object is completed to provide the associated citation for each reference.

### **B.12.1 Required Keywords**

#### 1. REFERENCE\_KEY\_ID

Note: If there are no relevant references to cite, the REFERENCE\_KEY\_ID should have a value of "N/A".

### **B.12.2 Optional Keywords**

None

### **B.12.3 Required Objects**

None

### **B.12.4 Optional Objects**

None

### **B.12.5 Example**

See the example for the DATA\_SET\_MAP\_PROJECTION object in Section B.8.5.

## B.13 IMAGE\_MAP\_PROJECTION

The IMAGE\_MAP\_PROJECTION object is one of two distinct objects that define the map projection used in creating the digital images in a PDS data set. The name of the other associated object that completes the definition is DATA\_SET\_MAP\_PROJECTION (see Appendix B.8).

The map projection information resides in these two objects, essentially to reduce data redundancy and at the same time allow the inclusion of elements needed to process the data at the image level. Basically, static information that is applicable to the complete data set reside in the DATA\_SET\_MAP\_PROJECTION object, while dynamic information that is applicable to the individual images reside in the IMAGE\_MAP\_PROJECTION object.

The LINE\_FIRST\_PIXEL, LINE\_LAST\_PIXEL, SAMPLE\_FIRST\_PIXEL, and SAMPLE\_LAST\_PIXEL keywords are used to indicate which way is up in an image. Sometimes an image can be shifted or flipped prior to its being physically recorded. These keywords are used in calculating the mapping of pixels between the original image and the stored image.

The following equations give the byte offsets needed to determine the mapping of a pixel (X,Y) from the original image to a pixel in the stored image:

The sample offset from the first pixel is:

$$\frac{\text{SAMPLE\_BITS} * (\text{Y} - \text{SAMPLE\_FIRST\_PIXEL}) * \text{LINE\_SAMPLES}}{8 * (\text{SAMPLE\_LAST\_PIXEL} - \text{SAMPLE\_FIRST\_PIXEL} + 1)}$$

The line offset from the first image line is:

$$\frac{(\text{X} - \text{LINE\_FIRST\_PIXEL}) * \text{LINES}}{(\text{LINE\_LAST\_PIXEL} - \text{LINE\_FIRST\_PIXEL} + 1)}$$

Additionally, in any image, ABS (SAMPLE\_LAST\_PIXEL - SAMPLE\_FIRST\_PIXEL + 1) is always equal to LINE\_SAMPLES, and ABS (LINE\_LAST\_PIXEL - LINE\_FIRST\_PIXEL + 1) is always equal to LINES.

### B.13.1 Example

Take a 1K by 1K 8-bit image which is rotated about the x-axis 180 degrees prior to being physically recorded.

Original Image: Positive direction is to the right and down

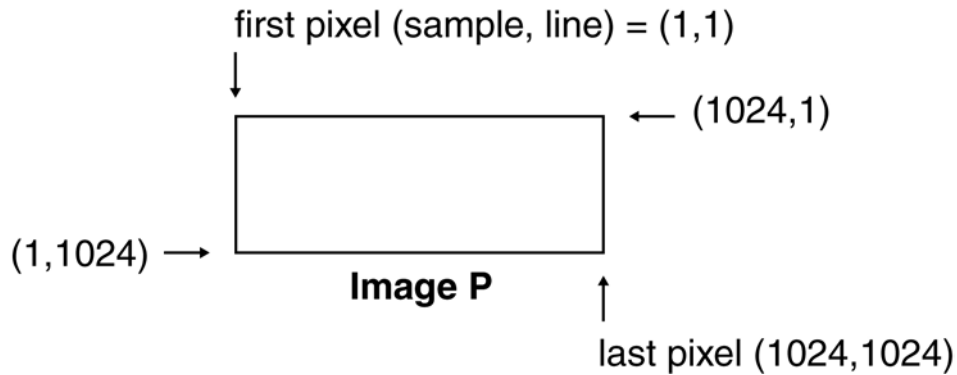

Stored Image: Positive direction is to the right and up

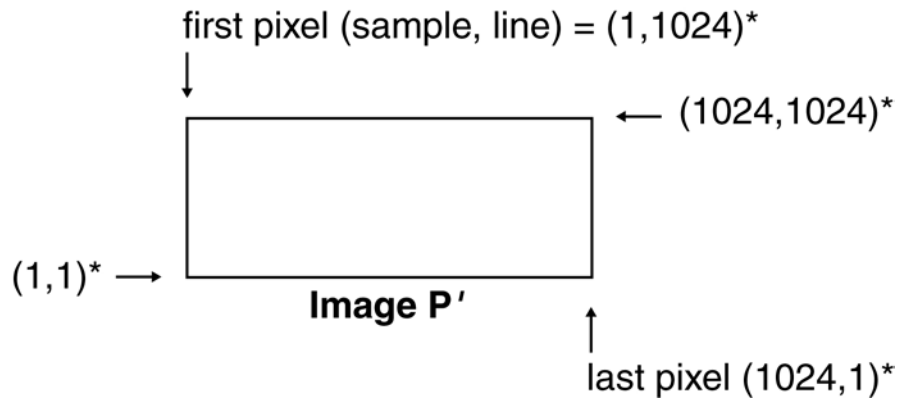

These pixel location values (\*) are the positions from the original image. For example, the first pixel in the stored image (normally referred to as (1,1)) came from the position (1,1024) in the original image. These original values are used for the following IMAGE\_MAP\_PROJECTION keywords in the PDS label for the stored image:

```
SAMPLE_FIRST_PIXEL = 1
SAMPLE_LAST_PIXEL  = 1024
LINE_FIRST_PIXEL   = 1024
LINE_LAST_PIXEL    = 1
```

Now, given a pixel on the original image,  $P(X,Y) = (2,2)$ , determine its location ( $P'$ ) in the stored image.

$$\text{sample offset} = (8 * (2 - 1) * 1024) / (8 * (1024 - 1 + 1)) = 1$$

$$\text{line offset} = ((2 - 1024) * 1024) / (1 - 1024 + 1) = (-1022)$$

Therefore,  $P'$  is located at (2, 1023) which is 1 byte from the first sample, and 1022 bytes (in the negative direction) from the first line in the stored image. See diagram above.

### **B.13.2 Required Keywords**

1. MAP\_PROJECTION\_TYPE
2. A\_AXIS\_RADIUS
3. B\_AXIS\_RADIUS
4. C\_AXIS\_RADIUS
5. FIRST\_STANDARD\_PARALLEL
6. SECOND\_STANDARD\_PARALLEL
7. POSITIVE\_LONGITUDE\_DIRECTION
8. CENTER\_LATITUDE
9. CENTER\_LONGITUDE
10. REFERENCE\_LATITUDE
11. REFERENCE\_LONGITUDE
12. LINE\_FIRST\_PIXEL
13. LINE\_LAST\_PIXEL
14. SAMPLE\_FIRST\_PIXEL
15. SAMPLE\_LAST\_PIXEL
16. MAP\_PROJECTION\_ROTATION
17. MAP\_RESOLUTION
18. MAP\_SCALE
19. MAXIMUM\_LATITUDE
20. MINIMUM\_LATITUDE
21. EASTERNMOST\_LONGITUDE
22. WESTERNMOST\_LONGITUDE
23. LINE\_PROJECTION\_OFFSET
24. SAMPLE\_PROJECTION\_OFFSET
25. COORDINATE\_SYSTEM\_TYPE
26. COORDINATE\_SYSTEM\_NAME

### **B.13.3 Optional Keywords**

1. DATA\_SET\_ID
2. IMAGE\_ID
3. HORIZONTAL\_FRAMELET\_OFFSET
4. VERTICAL\_FRAMELET\_OFFSET

### **B.13.4 Required Objects**

1. DATA\_SET\_MAP\_PROJECTION – This object is describe in Appendix B.

### B.13.5 Optional Objects

None

### B.13.6 Example

```

PDS_VERSION_ID                = PDS3

/* File characteristics */
RECORD_TYPE                    = STREAM

/* Identification data elements */
DATA_SET_ID                    = "MGN-V-RDRS-5-GVDR-V1.0"
DATA_SET_NAME                  = "MAGELLAN VENUS RADAR SYSTEM GLOBAL
    DATA RECORD V1.0"
PRODUCT_ID                     = "IMP-NORTH.100"

MISSION_NAME                   = "MAGELLAN"
SPACECRAFT_NAME                = "MAGELLAN"
INSTRUMENT_NAME                = "VENUS"

ORBIT_START_NUMBER             = 376
ORBIT_STOP_NUMBER              = 4367
START_TIME                     = "N/A"
STOP_TIME                      = "N/A"
SPACECRAFT_CLOCK_START_COUNT  = "N/A"
SPACECRAFT_CLOCK_STOP_COUNT   = "N/A"

PRODUCT_CREATION_TIME          = 1994-05-07T22:09:27.000
PRODUCT_RELEASE_DATE           = 1994-05-13
PRODUCT_SEQUENCE_NUMBER        = 00000
PRODUCT_VERSION_TYPE           = "PRELIMINARY"

SOURCE_DATA_SET_ID             = {"MGN-V-RDRS-5-SCVDR-V1.0",
    "MGN-V-RDRS-CDR-ALT/RAD-V1.0"}
SOURCE_PRODUCT_ID              =
{"SCVDR.00376-00399.1", "SCVDR.00400-00499.1",
 "SCVDR.01100-01199.1", "SCVDR.01200-01299.1", "SCVDR.01300-01399.1",
 "SCVDR.01400-01499.1", "SCVDR.01500-01599.1", "SCVDR.01600-01699.1",
 "SCVDR.01700-01799.1", "SCVDR.01800-01899.1", "SCVDR.01900-01999.1",
 "ARCDRCD.001;2", "ARCDRCD.002;1", "ARCDRCD.003;1", "ARCDRCD.004;1",
 "ARCDRCD.005;1", "ARCDRCD.006;1", "ARCDRCD.007;1", "ARCDRCD.008;1",
 "ARCDRCD.017;1", "ARCDRCD.018;1", "ARCDRCD.019;1"}

SOFTWARE_FLAG                  = "Y"

PRODUCER_FULL_NAME             = "MICHAEL J. MAURER"
PRODUCER_INSTITUTION_NAME      = "STANFORD CENTER FOR RADAR ASTRONOMY"
PRODUCER_ID                     = "SCRA"
DESCRIPTION                     = "This file contains a single
    IMAGE_MAP_PROJECTION data object with an attached PDS label."

```

```

/* Data object definitions */
OBJECT = IMAGE_MAP_PROJECTION
  ^DATA_SET_MAP_PROJECTION = "DSMAP.CAT"
  COORDINATE_SYSTEM_TYPE = "BODY-FIXED ROTATING"
  COORDINATE_SYSTEM_NAME = "PLANETOCENTRIC"
  MAP_PROJECTION_TYPE = "STEREOGRAPHIC"
  A_AXIS_RADIUS = 6051.0 <KM>
  B_AXIS_RADIUS = 6051.0 <KM>
  C_AXIS_RADIUS = 6051.0 <KM>
  FIRST_STANDARD_PARALLEL = "N/A"
  SECOND_STANDARD_PARALLEL = "N/A"
  POSITIVE_LONGITUDE_DIRECTION = "EAST"
  CENTER_LATITUDE = 90
  CENTER_LONGITUDE = 0
  REFERENCE_LATITUDE = "N/A"
  REFERENCE_LONGITUDE = "N/A"
  LINE_FIRST_PIXEL = 1
  LINE_LAST_PIXEL = 357
  SAMPLE_FIRST_PIXEL = 1
  SAMPLE_LAST_PIXEL = 357
  MAP_PROJECTION_ROTATION = 0
  MAP_RESOLUTION = 5.79478 <PIXEL/DEGREE>
  MAP_SCALE = 18.225 <KM/PIXEL>
  MAXIMUM_LATITUDE = 90.00
  MINIMUM_LATITUDE = 60.00
  EASTERNMOST_LONGITUDE = 360.00
  WESTERNMOST_LONGITUDE = 0.00
  LINE_PROJECTION_OFFSET = 178
  SAMPLE_PROJECTION_OFFSET = 178
END_OBJECT

```



## B.14 INSTRUMENT

The INSTRUMENT catalog object is used to submit information about an instrument to PDS. Instruments are typically associated with a particular spacecraft or earth-based host, so the INSTRUMENT\_HOST\_ID keyword may identify either a valid SPACECRAFT\_ID or EARTH\_BASE\_ID. The catalog object includes a text description of the instrument and a sub-object for identifying reference information.

### B.14.1 Required Keywords

1. INSTRUMENT\_HOST\_ID
2. INSTRUMENT\_ID

### B.14.2 Optional Keywords

None

### B.14.3 Required Objects

1. INSTRUMENT\_INFORMATION
2. INSTRUMENT\_REFERENCE\_INFO

### B.14.4 Optional Objects

None

### B.14.5 Usage Notes

One INSTRUMENT\_INFORMATION catalog object must be completed for each instrument. A INSTRUMENT\_REFERENCE\_INFO catalog object is required for each individual reference associated with the instrument. All references should be included that are relevant to providing more detailed / specific instrument information; such as, description of the instrument, instrument documentation, review results, etc. These references may include published articles, books, papers, electronic publications, etc.

### B.14.6 Example

```
/* Template: Instrument Template
```

```
Rev: 1993-09-24
```

```
*/
```

```

/* Note:Complete one template for each instrument. Identify each          */
/* instrument reference by repeating the 3 lines for the                  */
/* INSTRUMENT_REFERENCE_INFO object. Also complete a separate            */
/* REFERENCE template for each new reference submitted to PDS.          */
/*                               */
/* Hierarchy:  INSTRUMENT                                                */
/*             INSTRUMENT_INFORMATION                                    */
/*             INSTRUMENT_REFERENCE_INFO                                */
/*                               */
PDS_VERSION_ID              = PDS3
LABEL_REVISION_NOTE        = "1998-07-01, Richard Simpson (STANFORD), initial;"
RECORD_TYPE                 = STREAM

OBJECT                      = INSTRUMENT
INSTRUMENT_HOST_ID         = "MGN"
INSTRUMENT_ID              = "RDRS"

OBJECT                      = INSTRUMENT_INFORMATION
INSTRUMENT_NAME            = "RADAR SYSTEM"
INSTRUMENT_TYPE            = "RADAR"
INSTRUMENT_DESC            = "

```

#### Instrument Overview

The Magellan radar system included a 3.7 m diameter high gain antenna (HGA) for SAR and radiometry and a smaller fan-beam antenna (ALTA) for altimetry. The system operated at 12.6 cm wavelength. Common electronics were used in SAR, altimetry, and radiometry modes. The SAR operated in a burst mode; altimetry and radiometry observations were interleaved with the SAR bursts.

Radiometry data were obtained by spending a portion of the time between SAR bursts and after altimeter operation in a passive (receive-only) mode, with the HGA antenna capturing the microwave thermal emission from the planet. Noise power within the 10-MHz receiver bandwidth was detected and accumulated for 50 ms. To reduce the sensitivity to receiver gain changes in this mode, the receiver was connected on alternate bursts first to a comparison dummy load at a known physical temperature and then to the HGA. The short-term temperature resolution was about 2 K; the long-term absolute accuracy after calibration was about 20 K.

The radar was manufactured by Hughes Aircraft Company and the 'build date' is taken to be 1989-01-01. The radar dimensions were 0.304 by 1.35 by 0.902 (height by length by width in meters) and the mass was 126.1 kg.

```

Instrument Id                : RDRS
Instrument Host Id          : MGN
Pi PDS User Id             : GPETTENGILL
Instrument Name             : RADAR SYSTEM
Instrument Type             : RADAR
Build Date                  : 1989-01-01
Instrument Mass             : 126.100000
Instrument Length           : 1.350000
Instrument Width            : 0.902000
Instrument Height           : 0.304000
Instrument Manufacturer Name : HUGHES AIRCRAFT

```

#### Platform Mounting Descriptions

The spacecraft +Z axis vector was in the nominal direction of the HGA boresight. The +X axis vector was parallel to the nominal rotation axis of the solar panels. The +Y axis vector formed a right-handed coordinate system and was in the nominal direction of the star scanner boresight. The spacecraft velocity vector was in approximately the -Y direction when the spacecraft was oriented for left-looking SAR operation. The nominal HGA polarization was linear in the y-direction.

```

Cone Offset Angle           : 0.00
Cross Cone Offset Angle     : 0.00
Twist Offset Angle          : 0.00

```

The altimetry antenna boresight was in the x-z plane 25 degrees from the +Z direction and 65 degrees from the +X direction. The altimetry antenna was aimed approximately toward nadir during nominal radar operation. The altimetry antenna polarization was linear in the y-direction.

The medium gain antenna boresight was 70 degrees from the +Z direction and 20 degrees from the -Y direction. The low gain antenna was mounted on the back of the HGA feed; it's boresight was in the +Z direction and it had a hemispherical radiation pattern.

#### Principal Investigator

The Principal Investigator for the radar instrument was Gordon H. Pettengill.

For more information on the radar system see the papers by [JOHNSON1990] and [SAUNDERSETAL1990].

#### Scientific Objectives

=====

See MISSION\_OBJECTIVES\_SUMMARY under MISSION.

#### Operational Considerations

=====

The Magellan radar system was used to acquire radar back-scatter(SAR) images, altimetry, and radiometry when the spacecraft was close to the planet. Nominal operation extended from about 20minutes before periapsis until about 20 minutes after periapsis. In the SAR mode output from the radar receiver was sampled, blocks of samples were quantized using an adaptive procedure, and the results were stored on tape. In the altimetry mode samples were recorded directly, without quantization. Radiometry measurements were stored in the radar header records. During most of the remainder of each orbit, the HGA was pointed toward Earth and the contents of the tape recorder were transmitted to a station of the DSN at approximately 270 kilobits/second. SAR, altimetry, and radiometry data were then processed using ground software into images, altimetry profiles, estimates of backscatter coefficient, emissivity, and other quantities.

#### Calibration

=====

The radar was calibrated before flight using an active electronic target simulator [CUEVAS1989].

#### Operational Modes

=====

The Magellan radar system consisted of the following sections, each of which operated in the following modes:

##### Section Mode

-----

SAR	Synthetic Aperture Radar (SAR)
ALT	Altimetry
RAD	Radiometry

##### (1) SAR Characteristics

In the Synthetic Aperture Radar mode, the radar transmitted bursts of phase-modulated pulses through its high gain antenna. Echo signals were captured by the antenna, simple data the receiver output, and stored on tape after being quantized to reduce data volume. Pulse repetition rate and incidence angle were chosen to meet a minimum signal-to-noise ratio requirement (8 dB) for image pixels after ground processing. Multiple looks were used in processing to reduce speckle noise. Incidence angles varied from about 13 degrees at the pole to about 44 degrees at periapsis during normal mapping operations (e.g., Cycle 1); but other 'look angle profiles' were used during the mission.

Peak transmit power	: 350 watts
Transmitted pulse length	: 26.5 microseconds
Pulse repetition frequency	: 4400-5800 per sec
Time bandwidth product	: 60
Inverse baud width	: 2.26 MHz
Data quantization (I and Q)	: 2 bits each
Recorded data rate	: 750 kilobits/sec
Polarization (nominal)	: linear horizontal
HGA half-power full beam width	: 2.2 deg (azimuth)
	: 2.5 deg (elev)
one-way gain (from SAR RF port)	: 35.7
dBi System temperature (viewing Venus)	: 1250 K
Surface resolution (range)	: 120-360 m
(along track)	: 120-150 m
Number of looks	: 4 or more
Swath width	: 25 km (approx)
Antenna look angle	: 13-47 deg
Incidence angle on surface	: 18-50 deg

Data Path Type	: RECORDED DATA
PLAYBACK Instrument Power Consumption	: UNK

##### (2) ALT Characteristics

After SAR bursts (typically several times a second) groups of altimeter pulses were transmitted from a dedicated fan beam altimeter antenna (ALTA) directed toward the spacecraft's nadir. Output from the radar receiver was sampled, and the samples were stored on tape for transmission to Earth. During nominal left-looking SAR operation the ALTA pointed approximately 20 deg to the left of the spacecraft ground track at periapsis and about 10 deg to the right of the ground track near the north and south pole.

```

Data quantization (I and Q)          : 4 bits each
Recorded data rate                   : 35 kbs
Polarization                         : linear
ALTA half-power full beam width
  (along track)                      : 11 deg
  (cross track)                      : 31 deg
one-way gain referenced to ALT RF port : 18.9
dBi ALTA offset from HGA             : 25 deg
Burst interval                       : 0.5-1.0 sec
duration                             : 1.0 millisec
Dynamic range                         : 30 dB (or more)

Data Path Type                       : RECORDED DATA
PLAYBACK Instrument Power Consumption : UNK

```

## (3) RAD Characteristics

Radiometry measurements were made by the radar receiver and HGA in a receive-only mode that was activated after the altimetry mode to record the level of microwave radio thermal emission from the planet. Noise power within the 10-MHz receiver bandwidth was detected and accumulated for 50 ms. To reduce the sensitivity to receiver gain changes in this mode, the receiver was connected on alternate bursts first to a comparison dummy load at a known physical temperature and then to the HGA. The short-term temperature resolution was about 2K; the long-term absolute accuracy after calibration was about 20 K. At several times during the mission, radiometry measurements were carried out using known cosmic radio sources.

```

Receiver Bandwidth                   : 10 MHz
Integration Time                     : 50 millisecs
Polarization (nominal)               : linear horizontal
Data Quantization                    : 12 bits
Data Rate                            : 10-48 bits/sec
HGA half-power full beam width       : 2.2 deg
System temperature (viewing Venus)   : 1250 K
Antenna look angle                   : 13-47 deg
Incidence angle on surface           : 18-50 deg
Surface resolution (along track)     : 15-120 km
  (cross track)                     : 20-125 km

Data Path Type                       : RECORDED DATA PLAYBACK
Instrument Power Consumption          : UNK "

```

```

END_OBJECT                          = INSTRUMENT_INFORMATION

OBJECT                               = INSTRUMENT_REFERENCE_INFO
  REFERENCE_KEY_ID                   = "CUEVAS1989"
END_OBJECT                           = INSTRUMENT_REFERENCE_INFO

OBJECT                               = INSTRUMENT_REFERENCE_INFO
  REFERENCE_KEY_ID                   = "JOHNSON1990"
END_OBJECT                           = INSTRUMENT_REFERENCE_INFO

OBJECT                               = INSTRUMENT_REFERENCE_INFO
  REFERENCE_KEY_ID                   = "SAUNDERSETAL1990"
END_OBJECT                           = INSTRUMENT_REFERENCE_INFO

END_OBJECT                           = INSTRUMENT

END

```

## B.15 INSTRUMENT\_HOST

The INSTRUMENT\_HOST catalog object is used to describe a variety of instrument hosts, such as a spacecraft or an earth-based observatory.

### B.15.1 Required Keywords

1. INSTRUMENT\_HOST\_ID

### B.15.2 Optional Keywords

None

### B.15.3 Required Objects

1. INSTRUMENT\_HOST\_INFORMATION
2. INSTRUMENT\_HOST\_REFERENCE\_INFO

### B.15.4 Optional Objects

None

### B.15.5 Usage Notes

One INSTRUMENT\_HOST\_INFORMATION catalog object must be completed for each instrument host. An INSTRUMENT\_HOST\_REFERENCE\_INFO catalog object is required for each individual reference associated with the instrument host. All references should be included that are relevant to providing more detailed / specific instrument host information; such as, description of the instrument host, instrument host documentation, review results, etc. These references may include published articles, books, papers, electronic publications, etc.

### B.15.6 Example

```

/* Template: Instrument Host Template                               Rev: 1993-09-24          */
/* Note: Complete one template for each instrument host. Identify each      */
/* instrument host reference by repeating the 3 lines for the                */
/* INSTRUMENT_HOST_REFERENCE_INFO object. Also complete a separate          */
/* REFERENCE template for each new reference submitted to PDS.              */

```

```
/* Hierarchy:  INSTRUMENT_HOST                               */
/*            INSTRUMENT_HOST_INFORMATION                   */
/*            INSTRUMENT_HOST_REFERENCE_INFO               */
/*            */

PDS_VERSION_ID          = PDS3
LABEL_REVISION_NOTE    = "1998-07-01, Richard Simpson (STANFORD), initial;"
RECORD_TYPE             = "STREAM"

OBJECT                  = INSTRUMENT_HOST
  INSTRUMENT_HOST_ID    = "MGN"

OBJECT                  = INSTRUMENT_HOST_INFORMATION
  INSTRUMENT_HOST_NAME  = "MAGELLAN"
  INSTRUMENT_HOST_TYPE  = "SPACECRAFT"
  INSTRUMENT_HOST_DESC  = ""

Instrument Host Overview
=====
```

## **B.16 INSTRUMENT\_HOST\_INFORMATION**

The INSTRUMENT\_HOST\_INFORMATION object, a sub-object of the INSTRUMENT\_HOST catalog object, provides a description of an instrument host. For spacecraft, this typically includes paragraphs on the various subsystems. Earth-based instrument host descriptions generally focus on geographic and facility elements.

### **B.16.1 Required Keywords**

1. INSTRUMENT\_HOST\_DESC
2. INSTRUMENT\_HOST\_NAME
3. INSTRUMENT\_HOST\_TYPE

### **B.16.2 Optional Keywords**

None

### **B.16.3 Required Objects**

None

### **B.16.4 Optional Objects**

None

### **B.16.5 Usage Notes**

The INSTRUMENT\_HOST\_DESC keyword contains a text description of the spacecraft or ground observatory. It should contain at least one heading, “Instrument Host Overview”. This section should provide a high-level description of the characteristics and properties of the host. Other headings and sub-headings may be added as needed.

### **B.16.6 Example**

See the example for the INSTRUMENT\_HOST object in Section B.15.5.

## **B.17 INSTRUMENT\_HOST\_REFERENCE\_INFO**

The INSTRUMENT\_HOST\_REFERENCE\_INFO object, a sub-object of the INSTRUMENT\_HOST catalog object, associates a reference with an instrument host. A separate object must be completed for each reference cited within the INSTRUMENT\_HOST catalog object.

A separate REFERENCE catalog object is completed to provide the associated citation for each reference.

### **B.17.1 Required Keywords**

#### 1. REFERENCE\_KEY\_ID

Note: If there are no relevant references to cite, the REFERENCE\_KEY\_ID should have a value of "N/A".

### **B.17.2 Optional Keywords**

None

### **B.17.3 Required Objects**

None

### **B.17.4 Optional Objects**

None

### **B.17.5 Example**

See the example for the INSTRUMENT\_HOST object in Section B.15.5.



## **B.18 INSTRUMENT\_INFORMATION**

The INSTRUMENT\_INFORMATION catalog object provides a description of the instrument.

### **B.18.1 Required Keywords**

1. INSTRUMENT\_DESC
2. INSTRUMENT\_NAME
3. INSTRUMENT\_TYPE

### **B.18.2 Optional Keywords**

None

### **B.18.3 Required Objects**

None

### **B.18.4 Optional Objects**

None

### **B.18.5 Usage Notes**

The following paragraph headings and suggested contents for the INSTRUMENT\_DESC text are strongly recommended as the minimal set of information necessary to adequately describe an instrument. Additional headings may be appropriate for specific instruments and these also may be added here. Should any of the recommended headings *not* appear within the description, they will be considered not applicable to the data set.

#### Instrument Overview

A high-level description of the characteristics and properties of an instrument

#### Scientific Objectives

The scientific objectives of data obtained from this instrument

#### Calibration

Methods/procedures/schedules of instrument calibration (calibration stability, parameters, etc.)

### Operational Considerations

Special circumstances or events that affect the instrument's ability to acquire high quality data, and which are reflected in the archive product. For example: spacecraft charging; thruster firings; contamination from other instruments; air quality; temperatures, etc.

### Detectors

General description of the detector(s), including things like type of detector used, sensitivity and noise levels, detector fields of view, geometric factors, instrument/detector mounting descriptions (offset angles, pointing positions, etc.)

### Electronics

Description of the instrument electronics and internal data processing (A-D converter)

### Filters

Description of instrument filters and filter calibrations (filter type, center wavelength, min/max wavelength), as applicable

### Optics

Description of instrument optics (focal lengths, transmittance, diameter, resolution, t\_number, etc.), as applicable

### Location

Latitude and longitude location, for earth-based instruments

### Operational Modes

Description of instrument configurations for data acquisitions. Description of "modes" (scan, gain, etc.) of data acquisition and of measured parameter(s) and/or data sampling rates or schemes used in each mode

### Subsystems

Logical subsystems of the instrument, including descriptions of each subsystem, how it's used, which "modes" make use of which subsystem, etc.

### Measured Parameters

Description of what the instrument measures directly (particle counts, magnetic field components, radiance, current/voltage ratios, etc.), plus descriptions and definitions of these measurements (min/max, noise levels, units, time interval between measurements, etc.)

OTHER - Data Supplier provided: Any other important information in additional headings as desired (e.g., data reduction, data compression, time-tagging, diagnostics, etc.)

### **B.18.6 Example**

See the example for the INSTRUMENT object in Section B.14.5.

## **B.19 INSTRUMENT\_REFERENCE\_INFO**

The INSTRUMENT\_REFERENCE\_INFO catalog object associates a reference with an instrument description. A separate object must be completed for each reference cited within the INSTRUMENT catalog object. Include any important references such as instrument description and calibration documents. These can be published articles, internal documents or informal memoranda.

A separate REFERENCE catalog object is completed to provide the associated citation for each reference.

### **B.19.1 Required Keywords**

#### 1. REFERENCE\_KEY\_ID

Note: If there are no relevant references to cite, the REFERENCE\_KEY\_ID should have a value of "N/A".

### **B.19.2 Optional Keywords**

None

### **B.19.3 Required Objects**

None

### **B.19.4 Optional Objects**

None

### **B.19.5 Example**

See the example for the INSTRUMENT object in Section B.14.5.

## B.20 INVENTORY

One INVENTORY catalog object is completed for each node responsible for orderable data sets from the PDS catalog. This object provides the inventory information necessary to facilitate the ordering of these data sets.

### B.20.1 Required Keywords

1. NODE\_ID

### B.20.2 Optional Keywords

None

### B.20.3 Required Objects

1. INVENTORY\_DATA\_SET\_INFO

### B.20.4 Optional Objects

None

### B.20.5 Example

```

/* Template: InventoryTemplate                               Rev: 1990-03-20                               */
/* Note: The INVENTORY template shall be completed once for each node that is responsible   */
/* for orderable data sets from the PDS catalog. The following hierarchy of templates provide */
/* the necessary inventory information which will facilitate the ordering of these data sets. */

/* Hierarchy:  INVENTORY                                     */
/*             INVENTORY_DATA_SET_INFO                       */
/*             INVENTORY_NODE_MEDIA_INFO                     */

OBJECT          = INVENTORY
  NODE_ID       = "IMAGING"

  OBJECT        = INVENTORY_DATA_SET_INFO
    PRODUCT_DATA_SET_ID = "VG2-N-ISS-2-EDR-V1.0"

    OBJECT      = INVENTORY_NODE_MEDIA_INFO
      MEDIUM_TYPE = "MAG TAPE"
      MEDIUM_DESC = "INDUSTRY STD 1/2IN;1600 OR 6250 BPI"
      COPIES      = 1
      INVENTORY_SPECIAL_ORDER_NOTE = "Not applicable."
      END_OBJECT  = INVENTORY_NODE_MEDIA_INFO

    OBJECT      = INVENTORY_NODE_MEDIA_INFO
      MEDIUM_TYPE = "CD-ROM"

```

```

        MEDIUM_DESC           = "Compact Disk"
        COPIES                 = 1
        INVENTORY_SPECIAL_ORDER_NOTE = "Not applicable."
        END_OBJECT            = INVENTORY_NODE_MEDIA_INFO
    END_OBJECT                = INVENTORY_DATA_SET_INFO
END_OBJECT                  = INVENTORY

OBJECT                       = INVENTORY
NODE_ID                     = "NSSDC"

OBJECT                       = INVENTORY_DATA_SET_INFO
PRODUCT_DATA_SET_ID        = "VG2-N-ISS-2-EDR-V1.0"

OBJECT                       = INVENTORY_NODE_MEDIA_INFO
MEDIUM_TYPE                = "CD-ROM"
MEDIUM_DESC                 = "Compact Disk"
COPIES                      = 1
INVENTORY_SPECIAL_ORDER_NOTE = "Not applicable."
END_OBJECT                  = INVENTORY_NODE_MEDIA_INFO

END_OBJECT                  = INVENTORY_DATA_SET_INFO
END_OBJECT                  = INVENTORY
END

```

## **B.21 INVENTORY\_DATA\_SET\_INFO**

The INVENTORY\_DATA\_SET\_INFO object, sub-object of the INVENTORY catalog object, identifies a data set through the DATA\_SET\_ID. This object is repeated once for each orderable and cataloged PDS data set.

### **B.21.1 Required Keywords**

1. PRODUCT\_DATA\_SET\_ID

### **B.21.2 Optional Keywords**

None

### **B.21.3 Required Objects**

1. INVENTORY\_NODE\_MEDIA\_INFO

### **B.21.4 Optional Objects**

None

### **B.21.5 Example**

See the example for the INVENTORY object in Section B.20.5.

## **B.22 INVENTORY\_NODE\_MEDIA\_INFO**

The INVENTORY\_NODE\_MEDIA\_INFO object, a sub-object of the INVENTORY\_DATA\_SET\_INFO object, provides information about a data set's distribution medium. This object is repeated for each type of distribution medium.

### **B.22.1 Required Keywords**

1. COPIES
2. INVENTORY\_SPECIAL\_ORDER\_NOTE
3. MEDIUM\_DESC
4. MEDIUM\_TYPE

### **B.22.2 Optional Keywords**

None

### **B.22.3 Required Objects**

None

### **B.22.4 Optional Objects**

None

### **B.22.5 Example**

See the example for the INVENTORY object in Section B.20.5.



## **B.23 MISSION**

The MISSION catalog object is used to submit information about a mission or observing campaign to PDS. Sub-objects are included for identifying associated instrument hosts, targets, and references.

### **B.23.1 Required Keywords**

1. MISSION\_NAME

### **B.23.2 Optional Keywords**

None

### **B.23.3 Required Objects**

1. MISSION\_HOST
2. MISSION\_INFORMATION
3. MISSION\_REFERENCE\_INFORMATION

### **B.23.4 Optional Objects**

None

### **B.23.5 Usage Notes**

One MISSION\_INFORMATION catalog object must be completed for each mission. A MISSION\_HOST catalog object must be completed for each mission host associated with the mission, and one MISSION\_REFERENCE\_INFORMATION catalog object is required for each individual reference associated with the mission (e.g., articles, papers, memoranda, published data, etc.). All references should be included that are relevant to providing more detailed / specific mission information; such as, description of the mission, phases of the mission, mission objectives, mission documentation, review results, etc. These references may include published articles, books, papers, electronic publications, etc.

## B.23.6 Example

```

/* Template: Mission Template                               Rev: 1993-09-24          */
/* Note:Complete one template for each mission or campaign. Identify          */
/* multiple hosts associated with the mission by repeating the                 */
/* lines beginning and ending with the MISSION_HOST values. For               */
/* each instrument_host identified, repeat the 3 lines for the                 */
/* MISSION_TARGET object for each target associated with the host.            */
/* Also complete a separate REFERENCE template for each new                   */
/* reference submitted to PDS.                                                */
/* Hierarchy: MISSION                                                                    */
/*            MISSION_INFORMATION                                                    */
/*            MISSION_HOST                                                            */
/*            MISSION_TARGET                                                          */
/*            MISSION_REFERENCE_INFORMATION                                          */

```

```

PDS_VERSION_ID          = PDS3
LABEL_REVISION_NOTE    = "1998-07-01, Richard Simpson (STANFORD), initial;"
RECORD_TYPE            = STREAM

OBJECT                  = MISSION
MISSION_NAME           = "MAGELLAN"

OBJECT                  = MISSION_INFORMATION
MISSION_START_DATE     = 1989-05-04
MISSION_STOP_DATE      = UNK
MISSION_ALIAS_NAME     = "Venus Radar Mapper (VRM)"
MISSION_DESC           = "

```

### Mission Overview

=====

The Magellan spacecraft was launched from the Kennedy Space Center on 4 May 1989. The spacecraft was deployed from the Shuttle cargo bay after the Shuttle achieved parking orbit. Magellan, using an inertial upper stage rocket, was then placed into a Type IV transfer orbit to Venus where it carried out radar mapping and gravity studies starting in August 1990. The Mission has been described in many papers including two special issues of the Journal of Geophysical Research [VRMPP1983; SAUNDERSETAL1990; JGRMGN1992]. The radar system is also described in [JOHNSON1990].

The aerobraking phase of the mission was designed to change the Magellan orbit from eccentric to nearly circular. This was accomplished by dropping periapsis to less than 150 km above the surface and using atmospheric drag to reduce the energy in the orbit. Aerobraking ended on 3 August 1993, and periapsis was boosted above the atmosphere leaving the spacecraft in an orbit that was 540 km above the surface at apoapsis and 197 km above the surface at periapsis. The orbit period was 94 minutes. The spacecraft remained on its medium-gain antenna in this orbit until Cycle 5 began officially on 16 August 1993.

During Cycles 5 and 6 the orbit was low and approximately circular. The emphasis was on collecting high-resolution gravity data. Two bistatic surface scattering experiments were conducted, one on 6 October (orbits 9331, 9335, and 9336) and the second on 9 November (orbits 9846-9848).

### Mission Phases

=====

Mission phases were defined for significant spacecraft activity periods. During orbital operations a 'cycle' was approximately the time required for Venus to rotate once under the spacecraft (about 243 days). But there were orbit adjustments and other activities that made some mapping cycles not strictly contiguous and slightly longer or shorter than the rotation period.

#### PRELAUNCH

-----

The prelaunch phase extended from delivery of the spacecraft to Kennedy Space Center until the start of the launch countdown.

```

Spacecraft Id          : MGN
Target Name            : VENUS
Mission Phase Start Time : 1988-09-01
Mission Phase Stop Time  : 1989-05-04
Spacecraft Operations Type : ORBITER

```

#### LAUNCH

-----

The launch phase extended from the start of launch countdown until completion of the injection into the Earth- Venus trajectory.

Spacecraft Id	: MGN
Target Name	: VENUS
Mission Phase Start Time	: 1989-05-04
Mission Phase Stop Time	: 1989-05-04
Spacecraft Operations Type	: ORBITER

#### CRUISE

The cruise phase extended from injection into the Earth-Venus trajectory until 10 days before Venus orbit insertion.

Spacecraft Id	: MGN
Target Name	: VENUS
Mission Phase Start Time	: 1989-05-04
Mission Phase Stop Time	: 1990-08-01
Spacecraft Operations Type	: ORBITER

#### ORBIT INSERTION

The Venus orbit insertion phase extended from 10 days before Venus orbit insertion until burnout of the solid rocket injection motor.

Spacecraft Id	: MGN
Target Name	: VENUS
Mission Phase Start Time	: 1990-08-01
Mission Phase Stop Time	: 1990-08-10
Spacecraft Operations Type	: ORBITER

#### ORBIT CHECKOUT

The orbit trim and checkout phase extended from burnout of the solid rocket injection motor until the beginning of radar mapping.

Spacecraft Id	: MGN
Target Name	: VENUS
Mission Phase Start Time	: 1990-08-10
Mission Phase Stop Time	: 1990-09-15
Spacecraft Operations Type	: ORBITER

#### MAPPING CYCLE 1

The first mapping cycle extended from completion of the orbit trim and checkout phase until completion of one cycle of radar mapping (approximately 243 days).

Spacecraft Id	: MGN
Target Name	: VENUS
Mission Phase Start Time	: 1990-09-15
Mission Phase Stop Time	: 1991-05-15
Spacecraft Operations Type	: ORBITER

#### MAPPING CYCLE 2

The second mapping cycle extended from completion of the first mapping cycle through an additional cycle of mapping. Acquisition of 'right-looking' SAR data was emphasized. Radio occultation measurements were carried out on orbits 3212-3214. A period of battery reconditioning followed completion of Cycle 2.

Spacecraft Id	: MGN
Target Name	: VENUS
Mission Phase Start Time	: 1991-05-16
Mission Phase Stop Time	: 1992-01-17
Spacecraft Operations Type	: ORBITER

#### MAPPING CYCLE 3

The third mapping cycle extended from completion of battery reconditioning through an additional cycle of mapping (approximately 243 days). Acquisition of 'stereo' SAR data was emphasized. The last orbit in the third cycle was orbit 5747.

Spacecraft Id	: MGN
Target Name	: VENUS
Mission Phase Start Time	: 1992-01-24
Mission Phase Stop Time	: 1992-09-14
Spacecraft Operations Type	: ORBITER

#### MAPPING CYCLE 4

The fourth mapping cycle extended from completion of the third mapping cycle through an additional cycle of mapping. Acquisition of radio tracking data for gravity studies was emphasized. Radio occultation measurements were carried out on orbits 6369, 6370, 6471, and 6472. Because of poor observing geometry for gravity data collection at the beginning of the cycle, this cycle was extended 10 days beyond the nominal 243 days. Orbits included within the fourth cycle were 5748 through 7626. Periapsis was lowered on orbit 5752 to improve sensitivity to gravity features in Cycle 4.

```
Spacecraft Id           : MGN
Target Name             : VENUS
Mission Phase Start Time : 1992-09-14
Mission Phase Stop Time  : 1993-05-25
Spacecraft Operations Type : ORBITER
```

#### AEROBRAKING

The aerobraking phase extended from completion of the fourth mapping cycle through achievement of a near-circular orbit. Circularization was achieved more quickly than expected; the first gravity data collection in the circular orbit was not scheduled until 11 days later. Orbits included within the aerobraking phase were 7627 through 8392.

```
Spacecraft Id           : MGN
Target Name             : VENUS
Mission Phase Start Time : 1993-05-26
Mission Phase Stop Time  : 1993-08-05
Spacecraft Operations Type : ORBITER
```

#### MAPPING CYCLE 5

The fifth mapping cycle extended from completion of the aerobraking phase through an additional cycle of mapping (approximately 243 days). Acquisition of radio tracking data for gravity studies was emphasized. The first orbit in the fifth cycle was orbit 8393.

```
Spacecraft Id           : MGN
Target Name             : VENUS
Mission Phase Start Time : 1993-08-16
Mission Phase Stop Time  : 1994-04-15
Spacecraft Operations Type : ORBITER
```

#### MAPPING CYCLE 6

The sixth mapping cycle extended from completion of the fifth mapping cycle through an additional cycle of mapping (approximately 243 days). Acquisition of radio tracking data for gravity studies was emphasized. The first orbit in the sixth cycle was orbit 12249.

```
Spacecraft Id           : MGN
Target Name             : VENUS
Mission Phase Start Time : 1994-04-16
Mission Phase Stop Time  : TBD
Spacecraft Operations Type : ORBITER"
```

MISSION\_OBJECTIVES\_SUMMARY = "

#### Mission Objectives Overview

##### Volcanic and Tectonic Processes

Magellan images of the Venus surface show widespread evidence for volcanic activity. A major goal of the Magellan mission was to provide a detailed global characterization of volcanic land forms on Venus and an understanding of the mechanics of volcanism in the Venus context. Of particular interest was the role of volcanism in transporting heat through the lithosphere. While this goal will largely be accomplished by a careful analysis of images of volcanic features and of the geological relationships of these features to tectonic and impact structures, an essential aspect of characterization will be an integration of image data with altimetry and other measurements of surface properties....

For more information on volcanic and tectonic investigations see papers by [HEADETAL1992] and [SOLOMONETAL1992], respectively.

##### Impact Processes

The final physical form of an impact crater has meaning only when the effects of the cratering event and any subsequent modification of the crater can be distinguished. To this end, a careful search of the SAR images can identify and characterize both relatively pristine and degraded impact craters, together with their ejecta deposits (in each size range) as well as distinguishing impact craters from those of volcanic origin. The topographic measures of depth-to-diameter ratio, ejecta thickness distribution as a

function of distance from the crater, and the relief of central peaks contribute to this documentation.

For more information on investigations of impact processes see [SCHABERETAL1992].

#### Erosional, Depositional, and Chemical Processes

The nature of erosional and depositional processes on Venus is poorly known, primarily because the diagnostic landforms typically occur at a scale too small to have been resolved in Earth-based or Venera 15/16 radar images. Magellan images show wind eroded terrains, landforms produced by deposition (dunefields), possible landslides and other down slope movements, as well as aeolian features such as radar bright or dark streaks 'downwind' from prominent topographic anomalies. One measure of weathering, erosion, and deposition is provided by the extent to which soil covers the surface (for Venus, the term soil is used for porous material, as implied by its relatively low value of bulk dielectric constant). The existence of such material, and its dependence on elevation and geologic setting, provide important insights into the interactions that have taken place between the atmosphere and the lithosphere.

For more information on erosional, depositional, and chemical processes see papers by [ARVIDSONETAL1992], [GREELEYETAL1992], and [GREELEYETAL1994].

#### Isostatic and Convective Processes

Topography and gravity are intimately and inextricably related, and must be jointly examined when undertaking geophysical investigations of the interior of a planet, where isostatic and convective processes dominate. Topography provides a surface boundary condition for modeling the interior density of Venus.

For more information on topography and gravity see papers by [FORD&PETTENGILL1992], [KONOPLIVETAL1993], and [MCNAMEEETAL1993]. "

```

END_OBJECT                = MISSION_INFORMATION
OBJECT
  INSTRUMENT_HOST_ID      = MISSION_HOST
                           = "MGN"
OBJECT
  TARGET_NAME             = MISSION_TARGET
                           = "VENUS"
  END_OBJECT              = MISSION_TARGET
END_OBJECT                = MISSION_HOST
OBJECT                    = MISSION_REFERENCE_INFORMATION
  REFERENCE_KEY_ID        = "ARVIDSON1991"
END_OBJECT                = MISSION_REFERENCE_INFORMATION
OBJECT                    = MISSION_REFERENCE_INFORMATION
  REFERENCE_KEY_ID        = "ARVIDSONETAL1992"
END_OBJECT                = MISSION_REFERENCE_INFORMATION
OBJECT                    = MISSION_REFERENCE_INFORMATION
  REFERENCE_KEY_ID        = "CAMPBELLETAL1992"
END_OBJECT                = MISSION_REFERENCE_INFORMATION
...
OBJECT                    = MISSION_REFERENCE_INFORMATION
  REFERENCE_KEY_ID        = "TYLER1992"
END_OBJECT                = MISSION_REFERENCE_INFORMATION
OBJECT                    = MISSION_REFERENCE_INFORMATION
  REFERENCE_KEY_ID        = "VRMPP1983"
END_OBJECT                = MISSION_REFERENCE_INFORMATION
END_OBJECT                = MISSION
END

```

## **B.24 MISSION\_HOST**

The MISSION\_HOST object, a sub-object of the MISSION catalog object, is completed for each instrument host associated with a mission or observing campaign. If there is more than one instrument host involved in the mission, this object is repeated.

### **B.24.1 Required Keywords**

1. INSTRUMENT\_HOST\_ID

### **B.24.2 Optional Keywords**

None

### **B.24.3 Required Objects**

1. MISSION\_TARGET

### **B.24.4 Optional Objects**

None

### **B.24.5 Example**

See the example for the MISSION object in Section B.23.5.

## **B.25 MISSION\_INFORMATION**

The MISSION\_INFORMATION object, a sub-object of the MISSION catalog object, provides start and stop times and text descriptions of a mission (or observing campaign) and its objectives. Suggested content includes agency involvement, spacecraft/observatory utilized, mission scenario including phases, technology and scientific objectives.

### **B.25.1 Required Keywords**

1. MISSION\_ALIAS\_NAME
2. MISSION\_DESC
3. MISSION\_OBJECTIVES\_SUMMARY
4. MISSION\_START\_DATE
5. MISSION\_STOP\_DATE

### **B.25.2 Optional Keywords**

None

### **B.25.3 Required Objects**

None

### **B.25.4 Optional Objects**

None

### **B.25.5 Usage notes**

The following paragraph headings and suggested contents for the MISSION\_DESC and MISSION\_OBJECTIVES\_SUMMARY text are strongly recommended as the minimal set of information necessary to adequately describe a mission or observing campaign. Additional headings may be added as needed.

**B.25.5.1 MISSION\_DESC Headings**Mission Overview

A high-level description of a mission

Mission Phases

A description of each phase of a mission, starting with the pre-launch phase and continuing through end-of-mission, including: start and stop times of each phase; intended operations; targets; and mission phase objectives

**B.25.5.2 MISSION\_OBJECTIVES\_SUMMARY Headings**Mission Objectives Overview

A high-level description of the objectives of the mission

**B.25.6 Example**

See the example for the MISSION object in Section B.23.5.



## **B.26 MISSION\_REFERENCE\_INFORMATION**

The MISSION\_REFERENCE\_INFORMATION object, a sub-object of the MISSION catalog object, associates a reference with a mission. A separate object must be completed for each reference cited within the MISSION catalog object.

A separate REFERENCE catalog object is completed to provide the associated citation for each reference.

### **B.26.1 Required Keywords**

#### 1. REFERENCE\_KEY\_ID

Note: If there are no relevant references to cite, the REFERENCE\_KEY\_ID should have a value of "N/A".

### **B.26.2 Optional Keywords**

None

### **B.26.3 Required Objects**

None

### **B.26.4 Optional Objects**

None

### **B.26.5 Example**

See the example for the MISSION object in Section B.23.5.

## **B.27 MISSION\_TARGET**

The MISSION\_TARGET object, a sub-object of the MISSION\_HOST catalog object, associates a target with a mission host. One MISSION\_TARGET catalog object is completed for each target associated with a mission host.

### **B.27.1 Required Keywords**

1. TARGET\_NAME

### **B.27.2 Optional Keywords**

None

### **B.27.3 Required Objects**

None

### **B.27.4 Optional Objects**

None

### **B.27.5 Example**

See the example for the MISSION object in Section B.23.5.

## **B.28 PERSONNEL**

The PERSONNEL catalog object is used to provide new or updated information for personnel associated with PDS in some capacity. Associated personnel include data suppliers and producers for data sets or volumes archived with PDS, as well as PDS node personnel and contacts within other agencies and institutions.

### **B.28.1 Required Keywords**

#### 1. PDS\_USER\_ID

Note: With respect to new submissions, contact a PDS Data Engineer to obtain a valid and unique PDS\_USER\_ID. The value is constructed using the initial of the first name and the last name (e.g., John Smith would become PDS\_USER\_ID = "JSMITH"). The Data Engineer will ensure that the newly constructed value does not conflict with a previous entry in the catalog.

### **B.28.2 Optional Keywords**

None

### **B.28.3 Required Objects**

1. PERSONNEL\_ELECTRONIC\_MAIL
2. PERSONNEL\_INFORMATION

### **B.28.4 Optional Objects**

None

### **B.28.5 Usage Notes**

One PERSONNEL\_INFORMATION catalog object must be completed for each person. One PERSONNEL\_ELECTRONIC\_MAIL catalog object must be completed for each email address associated with the person. That is, if there is more than one email address, this object is repeated.

## B.28.6 Example

```

/* Template: Personnel Template                               Rev: 1993-09-24      */
/* Note:Complete one for each new PDS user, data supplier, or data      */
/*producer. If more than one electronic mail address is available        */
/*repeat the lines for the PERSONNEL_ELECTRONIC_MAIL object.            */
/* Hierarchy: PERSONNEL                                         */
/*                PERSONNEL_INFORMATION                         */
/*                PERSONNEL_ELECTRONIC_MAIL                     */
PDS_VERSION_ID          = PDS3
LABEL_REVISION_NOTE    = "1998-07-01, Richard Simpson (STANFORD), initial;"
RECORD_TYPE            = STREAM

OBJECT                  = PERSONNEL
  PDS_USER_ID          = PFORD

  OBJECT                = PERSONNEL_INFORMATION
    FULL_NAME          = "PETER G. FORD"
    LAST_NAME          = FORD
    TELEPHONE_NUMBER   = "6172536485"
    ALTERNATE_TELEPHONE_NUMBER = "6172534287"
    FAX_NUMBER         = "6172530861"
    INSTITUTION_NAME   = "MASSACHUSETTS INSTITUTE OF TECHNOLOGY"
    NODE_ID            = "GEOSCIENCE"
    PDS_AFFILIATION    = "NODE OPERATIONS MANAGER"
    PDS_ADDRESS_BOOK_FLAG = Y
    REGISTRATION_DATE  = 1990-02-06
    ADDRESS_TEXT       = "Massachusetts Institute of Technology
                        Center for Space Research Building 37-601
                        Cambridge, MA 02139"
  END_OBJECT          = PERSONNEL_INFORMATION

  OBJECT                = PERSONNEL_ELECTRONIC_MAIL
    ELECTRONIC_MAIL_ID = "PGF@SPACE.MIT.EDU"
    ELECTRONIC_MAIL_TYPE = "INTERNET"
    PREFERENCE_ID      = 1
  END_OBJECT          = PERSONNEL_ELECTRONIC_MAIL

  OBJECT                = PERSONNEL_ELECTRONIC_MAIL
    ELECTRONIC_MAIL_ID = "PFORD"
    ELECTRONIC_MAIL_TYPE = "NASAMAIL"
    PREFERENCE_ID      = 2
  END_OBJECT          = PERSONNEL_ELECTRONIC_MAIL

  OBJECT                = PERSONNEL_ELECTRONIC_MAIL
    ELECTRONIC_MAIL_ID = "JPLPDS::PFORD"
    ELECTRONIC_MAIL_TYPE = "NSI/DECNET"
    PREFERENCE_ID      = 3
  END_OBJECT          = PERSONNEL_ELECTRONIC_MAIL

END_OBJECT            = PERSONNEL
END

```

## **B.29 PERSONNEL\_ELECTRONIC\_MAIL**

The PERSONNEL\_ELECTRONIC\_MAIL object, a sub-object of the PERSONNEL catalog object, provides electronic mail information for an individual. This object may be repeated if more than one electronic mail address is applicable.

### **B.29.1 Required Keywords**

1. ELECTRONIC\_MAIL\_ID
2. ELECTRONIC\_MAIL\_TYPE
3. PREFERENCE\_ID

### **B.29.2 Optional Keywords**

None

### **B.29.3 Required Objects**

None

### **B.29.4 Optional Objects**

None

### **B.29.5 Example**

See the example for the PERSONNEL object in Section B.28.5.

## **B.30 PERSONNEL\_INFORMATION**

The PERSONNEL\_INFORMATION object, a sub-object of the PERSONNEL catalog object, provides name, address, telephone, and related information for an individual.

### **B.30.1 Required Keywords**

1. ADDRESS\_TEXT
2. ALTERNATE\_TELEPHONE\_NUMBER
3. FAX\_NUMBER
4. FULL\_NAME
5. INSTITUTION\_NAME
6. LAST\_NAME
7. NODE\_ID
8. PDS\_AFFILIATION
9. REGISTRATION\_DATE
10. TELEPHONE\_NUMBER

### **B.30.2 Optional Keywords**

1. PDS\_ADDRESS\_BOOK\_FLAG

### **B.30.3 Required Objects**

None

### **B.30.4 Optional Objects**

None

### **B.30.5 Example**

See the example for the PERSONNEL object in Section B.28.5.

## B.31 REFERENCE

The REFERENCE catalog object provides a citation and a unique identifier for every journal article, book, chapter, or other reference mentioned in a CATALOG object or one of its components (MISSION, INSTRUMENT HOST, INSTRUMENT, DATA SET, etc.).

One REFERENCE catalog object should be completed for each reference associated with a CATALOG (or component) object. Since the goal in generating REFERENCE catalog objects is to provide additional external long-term documentation, care should be exercised in selecting candidate references. Internal documents, informal memoranda, and other unpublished material should be avoided. A REFERENCE should cite published data, such as other PDS archives. Multiple REFERENCE catalog objects are often assembled into a single REF.CAT file to accompany an archive.

### B.31.1 Required Keywords

1. REFERENCE\_KEY\_ID
2. REFERENCE\_DESC

### B.31.2 Optional Keywords

None

### B.31.3 Required Objects

None

### B.31.4 Optional Objects

None

### B.31.5 Usage Notes

The following examples show how to cite various types of information in REFERENCE catalog objects for PDS archive products. PDS has elected to use the American Geophysical Union (AGU) reference citation formats. The information presented within this section was derived from and complies with AGU's formats for publication (see [www.agu.org/pubs/references.html](http://www.agu.org/pubs/references.html))

for more information). For assistance in determining the proper format for a citation that does not fit within one of the categories described here, contact a PDS Data Engineer.

#### **B.31.5.1 Materials Appropriate for Inclusion in a REFERENCE Catalog Object**

Each article, book, report, electronic collection (CD-ROM or electronic publication), thesis, or similar publication used in documenting a PDS archival product should be defined by a REFERENCE catalog object.

#### **B.31.5.2 Materials Inappropriate for Inclusion in a REFERENCE Catalog Object**

Unpublished materials such as personal communications, unpublished reports, papers presented at meetings, and manuscripts in preparation or submitted for publication but not yet formally accepted are not allowed in REFERENCE catalog objects; PDS does not consider them to be part of the literature. Likewise, internal memoranda and documents should be avoided unless they can be accessed by outside users. Papers accepted but without final publication data (volume, page numbers, dates, etc.) are discouraged since the information in the REFERENCE catalog object would be incomplete and need to be updated later.

In cases where it would be desirable to credit another author or group for contributions or prior work, an in-line text acknowledgement or citation is acceptable, even when the material is not readily accessible. If such material is required for understanding the archive, the normal constraints apply, however.

#### **B.31.5.3 Reference List Citations**

The most widely accessible source of a particular piece of material should be cited. For example, if an article exists as an internal publication and in a professional journal, the latter should be used in the REFERENCE catalog object.

#### **B.31.5.4 Construction of REFERENCE\_KEY\_ID**

1. For a single author, the REFERENCE\_KEY\_ID comprises the author's surname followed by the year of the publication (e.g., "SMITH1990").
2. For two authors, the REFERENCE\_KEY\_ID comprises the author's surname followed by "&" followed by the co-author's surname followed by the year of the publication (e.g., "LAUREL&HARDY1990").
3. For more than two authors, the REFERENCE\_KEY\_ID comprises the first author's surname followed by "ETAL" followed by the year of the publication (e.g., "SMITHE TAL1990").
4. If the same author(s) published more than one paper in the same year, the following applies:



- a. The initial publication will have a REFERENCE\_KEY\_ID as formulated above (e.g., "SMITH1990"). Note that the reference uses an implicit "A".
  - b. Subsequent publications will use the next sequential letter to uniquely identify the reference:
    - the 2nd publication will be "SMITH1990B",
    - the 3rd publication will be "SMITH1990C".
5. The REFERENCE\_KEY\_ID value should be enclosed within double quotes.
  6. For additional information on formulating a REFERENCE\_KEY\_ID, check the PDS Data Dictionary (<http://pdsproto.jpl.nasa.gov/onlinecatalog/top.cfm>).

### **B.31.5.5 Construction of REFERENCE\_DESC**

The information included in a REFERENCE catalog object will vary somewhat depending on the source. The following subsections describe the most common types; contact a PDS Data Engineer for assistance when encountering a type not described here. Details on constructing the components of a REFERENCE\_DESC value are described in the next section.

#### **B.31.5.5.1 Papers in Professional Journals and Other Articles**

Citations of articles should include the following information in the order listed:

1. Name(s) of author or authors
2. Title of article
3. Name of periodical
4. Volume and/or issue number
5. First and last pages occupied by article
6. Year of publication

#### ***Example:***

```

OBJECT                = REFERENCE
REFERENCE_KEY_ID      = "SCARF&GURNETT1977"
REFERENCE_DESC        = "
    Scarf, F.L., and D.A. Gurnett, A plasma wave investigation for the
    Voyager mission, Space Sci. Rev., Vol. 21, No. 1, pp. 289-331, 1977."
END_OBJECT            = REFERENCE
  
```

#### **B.31.5.5.2 Books and Reports**

Citations of books and reports should include the following information, in the order listed:

1. Name(s) of author or authors
2. Title of article or chapter (if only part of book or report is being cited)

3. Title of book or report
4. Volume number (if part of a multivolume series)
5. Edition (if not original)
6. Editor(s) (if any)
7. Report number(s)
8. Page numbers (if only part of book or report is being cited)
9. Publisher's name
10. City of publication
11. Year of publication

**Examples:**

```

OBJECT                = REFERENCE
REFERENCE_KEY_ID     = "FIELDETAL1989B"
REFERENCE_DESC       = "
    Field, S.W., S.E. Haggerty, and A.J. Erlank, Subcontinental
    Metasomatism in the Region of Jagersfontein, Springer-Verlag,
    New York, 1989."
END_OBJECT           = REFERENCE

OBJECT                = REFERENCE
REFERENCE_KEY_ID     = "THOMPSON1985"
REFERENCE_DESC       = "
    Thompson, W.B., Preliminary investigation of the electrodynamic
    of a conducting tether, in Spacecraft Environmental Technology
    1983, edited by C. K. Purvis and C. P. Pike, NASA Conf. Publ.,
    Vol. 2359, pp. 649-662, National Aeronautics and Space Administration,
    Washington, DC, 1985."
END_OBJECT           = REFERENCE

```

### **B.31.5.5.3 Electronic Publications**

Certain types of electronic publications may be given as REFERENCE catalog objects. These include publications on electronic media such as CD-ROM and regularly issued, dated electronic journals. Data deposited at PDS and National Data Centers (e.g., NSSDC) may also be included. Because of the ephemeral nature of some electronic media, authors should consult a Data Engineer if the specific reference (e.g., a website) does not seem to have a traditional hardcopy analog.

#### **B.31.5.5.3.1 Data Sets**

REFERENCE catalog objects for data sets that are on deposit at PDS or National Data Centers (e.g., NSSDC) should include the following information, in the order listed:

1. Name of author or authors (e.g., Principal Investigator and/or Data Producer)
2. Name of the data set (e.g., DATA\_SET\_NAME)

3. Unique identifier of the data set (e.g., DATA\_SET\_ID)
4. Volume and/or issue number (e.g., VOLUME\_SET\_ID or VOLUME\_ID) (optional)
5. Name of publisher or producer (e.g., NASA Planetary Data System)
6. Year of publication

**Example:**

```

OBJECT                = REFERENCE
REFERENCE_KEY_ID     = "LEVINETAL2000"
REFERENCE_DESC       = "
    Levin, G.V., P.A. Straat, E.A. Guinness, P.G. Valko, J.H. King,
    and D.R. Williams, Viking Lander Labeled Release Data Archive,
    VL1/VL2-M-LCS-2-EDR-V1.0, USA_NASA_JPL_VL_9010, NASA
    Planetary Data System, 2000."
END_OBJECT           = REFERENCE

```

**B.31.5.5.3.2 Physical Media (CD-ROM / DVD-R)**

REFERENCE catalog objects for physical media (e.g., CDs or DVDs) should include the following information, in the order listed:

1. Name of author or authors (e.g., Principal Investigator and/or Data Producer)
2. Name of the volume or volume set (e.g., VOLUME\_NAME or VOLUME\_SET\_NAME)
3. Unique identifier of the volume or volume set (e.g., VOLUME\_ID or VOLUME\_SET\_ID)
4. Name of publisher or producer (e.g., NASA Planetary Data System)
5. Year of publication

**Example:**

```

OBJECT                = REFERENCE
REFERENCE_KEY_ID     = "LEVINETAL2000B"
REFERENCE_DESC       = "
    Levin, G.V., P.A. Straat, E.A. Guinness, P.G. Valko, J.H. King,
    and D.R. Williams, Viking Lander 1 Experiment Data Records (EDR)
    Image Products, USA_NASA_JPL_VL_00xx, NASA Planetary Data
    System, 2000."
END_OBJECT           = REFERENCE

```

**B.31.5.5.3.3 Electronic Journal Articles**

Material published in regularly issued, dated electronic journals should be referenced similarly to printed papers (see Papers in Professional Journals and Other Articles, above). Because this aspect of the Internet is evolving rapidly, PDS does not offer specific recommendations; authors should contact a Data Engineer for current guidelines. Because the Internet is a dynamic

environment and sites may change or move, PDS cautions that such electronic sources should have established a record of stability before being considered acceptable for use in REFERENCE catalog objects.

### B.31.5.6 REFERENCE\_DESC Components

#### B.31.5.6.1 Author Names

For the first author only, the surname is given first, followed by initials. Names of any co-authors appear in regular order: initials precede the co-author's surname. The word "and" precedes the last author's name. Do not include white space between authors' initials (e.g., Kurth, W.S.)

*Example:*

```
OBJECT                = REFERENCE
REFERENCE_KEY_ID     = "KURTHETAL1982"
REFERENCE_DESC       = "
Kurth, W.S., F.L. Scarf, J.D. Sullivan, and D.A. Gurnett,
Detection of nonthermal continuum radiation in Saturn's
magnetosphere, Geophys. Res. Lett., Vol. 9, p. 889, 1982."
END_OBJECT           = REFERENCE
```

#### B.31.5.6.2 Journal Titles

PDS uses the same guidelines as the AGU which were established by the *Chemical Abstracts Service Source Index* in abbreviating the names of serial publications and reports. One word titles (e.g., Science, Icarus, Nature) are not abbreviated. Articles, conjunctions, prepositions, hyphens, parentheses, commas, and accents are omitted in abbreviated titles. Apostrophes in transliterated titles are retained.

Examples of common journal titles in planetary science include:

- Adv. Space Res.
- Geophys. Res. Lett.
- J. Geophys. Res.
- Rev. Geophys.
- Radio Sci.
- Space Sci. Rev.

Other examples include:

- AAPG Bull.
- Anal. Chem.
- Ann. Geophys.
- Ann. Glaciol.

- Appl. Opt.
- Appl. Spectrosc.
- Astrophys. J.
- Bull. Int. Assoc. Eng. Geol.
- Bull. Mar. Sci.
- Can. J. Phys.
- Chem. Geol.
- Contrib. Mineral. Petrol.
- Earth Planet. Sci. Lett.
- Geochim. Cosmochim. Acta
- Geol. Soc. Am. Bull.
- IEEE Trans. Geosci. Remote Sens.
- IEEE Trans. Nucl. Sci.
- Int. J. Rock Mech. Min. Sci. Geomech. Abstr.
- J. Atmos. Chem.
- J. Atmos. Oceanic Technol.
- J. Atmos. Sci.
- J. Atmos. Terr. Phys.
- J. Fluid Mech.
- J. Geomagn. Geoelectr.
- J. High Resolut. Chromatogr.
- J. Petrol.
- J. Phys. Oceanogr.
- Mon. Weather Rev.
- Phys. Fluids
- Philos. Trans. R. Soc. London Ser. A
- Planet. Space Sci.
- Q. J. R. Meteorol. Soc.
- Remote Sens. Environ.
- Science

## B.32 SOFTWARE

The SOFTWARE catalog object provides general information about a software tool including description, availability information, and dependencies.

The SOFTWARE catalog object is completed for each software program registered in the PDS Software Inventory. This Inventory includes software available within the planetary science community, including software on PDS archive volumes. Of interest are any applications, tools, or libraries that have proven useful for the display, analysis, formatting, transformation, or preparation of either science data or meta-data for the PDS archives.

### B.32.1 Required Keywords

1. SOFTWARE\_ID
2. SOFTWARE\_VERSION\_ID

### B.32.2 Optional Keywords

None

### B.32.3 Required Objects

1. SOFTWARE\_INFORMATION
2. SOFTWARE\_ONLINE
3. SOFTWARE\_PURPOSE

### B.32.4 Optional Objects

None

### B.32.5 Example

```

/* Template: Software Template                               Rev: 1998-12-01          */
/* Note: This template should be completed to register software in the          */
/*       PDS Software Inventory.                                                */

PDS_VERSION_ID      = PDS3
LABEL_REVISION_NOTE = "1998-07-01, Richard Simpson (STANFORD), initial;"
RECORD_TYPE         = STREAM

OBJECT              = SOFTWARE
SOFTWARE_ID         = NASAVIEW

```

```

SOFTWARE_VERSION_ID          = "V1R2B"
OBJECT                       = SOFTWARE_INFORMATION
  SOFTWARE_NAME              = "NASAVIEW - PDS DATA PRODUCT ACCESS TOOL
                              V1.2B"
  DATA FORMAT               = PDS
  SOFTWARE_LICENSE_TYPE     = PUBLIC_DOMAIN
  TECHNICAL_SUPPORT_TYPE    = FULL
  REQUIRED_STORAGE_BYTES     = "1.8MB"
  PDS_USER_ID               = SHUGHES
  NODE_ID                   = CN
  SOFTWARE_DESC              = "

```

#### Software Overview

```
=====
```

NasaView Version 1.2b is a PDS Image display program developed for the following platforms:

- (a) PC / Win32
- (b) Unix / Sun OS

NasaView is capable of accessing and displaying all images, tables, cubes, and histograms in the PDS archive. This release has been tested using Galileo, Magellan, Viking, MDIM, Voyager, IHW LSPN, and Clementine uncompressed images.

NasaView is planned as a PDS data product object display utility that will run on SUN, MAC, and PC platforms in a GUI environment.

This application was built using the Label Library Light (L3), Object Access Library (OAL), and the XVT Development Solution for C package. Label Library Light parses PDS ODL labels and creates an in-memory representation of the label information. The Object Access Library uses the parse-tree and accesses the actual PDS object. The XVT Development Solution supplies the cross platform GUI and an Object-oriented environment. XVT allows the definition of visual objects such as Windows and Menus and associates events and code with them.

#### Available Support Material

```
=====
```

BINARIES

#### Programming Language

```
=====
```

SUN\_C

#### Platforms Supported

```
=====
```

PC / Microsoft Win95, Win98, NT4.0

#### Support Software Required / Used

```
=====
```

X\_WINDOWS

```

END_OBJECT                  = SOFTWARE_INFORMATION
OBJECT                      = SOFTWARE_ONLINE
  ON_LINE_IDENTIFICATION    = "http://pds.jpl.nasa.gov/license.html"
  ON_LINE_NAME              = "NASAVIEW REVISION 2 BETA"
  NODE_ID                   = CN
  PROTOCOL_TYPE             = URL
  PLATFORM                  = "PC/WIN32"
END_OBJECT                  = SOFTWARE_ONLINE
OBJECT                      = SOFTWARE_PURPOSE
  SOFTWARE_PURPOSE         = DISPLAY
END_OBJECT                  = SOFTWARE_PURPOSE
END_OBJECT                  = SOFTWARE
END

```

## **B.33 SOFTWARE\_INFORMATION**

The SOFTWARE\_INFORMATION object, a sub-object of SOFTWARE catalog object, provides basic identification and operating system information associated with a specific SOFTWARE object.

### **B.33.1 Required Keywords**

1. DATA\_FORMAT
2. NODE\_ID
3. PDS\_USER\_ID
4. REQUIRED\_STORAGE\_BYTES
5. SOFTWARE\_DESC
6. SOFTWARE\_LICENSE\_TYPE
7. SOFTWARE\_NAME
8. TECHNICAL\_SUPPORT\_TYPE

### **B.33.2 Optional Keywords**

None

### **B.33.3 Required Objects**

None

### **B.33.4 Optional Objects**

None

### **B.33.5 Example**

See the example for the SOFTWARE object in Section B.32.5.



## **B.34 SOFTWARE\_ONLINE**

The SOFTWARE\_ONLINE object, a sub-object of SOFTWARE catalog object, provides identifying information for each PDS node providing access to a particular SOFTWARE object.

### **B.34.1 Required Keywords**

1. NODE\_ID
2. ON\_LINE\_IDENTIFICATION
3. ON\_LINE\_NAME
4. PLATFORM
5. PROTOCOL\_TYPE

### **B.34.2 Optional Keywords**

None

### **B.34.3 Required Objects**

None

### **B.34.4 Optional Objects**

None

### **B.34.5 Example**

See the example for the SOFTWARE object in Section B.32.5.

## **B.35 SOFTWARE\_PURPOSE**

The SOFTWARE\_PURPOSE object, a sub-object of SOFTWARE catalog object, describes the functionality provided by a specific SOFTWARE object.

### **B.35.1 Required Keywords**

1. SOFTWARE\_PURPOSE

### **B.35.2 Optional Keywords**

None

### **B.35.3 Required Objects**

None

### **B.35.4 Optional Objects**

None

### **B.35.5 Example**

See the example for the SOFTWARE object in Section B.32.5.

## B.36 TARGET

The TARGET catalog object provides basic descriptive information for a single observational target.

### B.36.1 Required Keywords

1. TARGET\_NAME

### B.36.2 Optional Keywords

None

### B.36.3 Required Objects

1. TARGET\_INFORMATION

### B.36.4 Optional Objects

1. TARGET\_REFERENCE\_INFORMATION

### B.36.5 Usage Notes

One TARGET\_INFORMATION catalog object must be completed for each target. A TARGET\_REFERENCE\_INFORMATION catalog object is required for each individual reference associated with the target. All references should be included that are relevant to providing more detailed / specific target information; such as, type of target, orbit direction, description of the target, etc. These references may include published articles, books, papers, electronic publications, etc.

### B.36.6 Example

```

/* Template: Target Template                               Rev: 1995-01-01   */
/* Note: The following template is used for the           */
/* submission of a target to the PDS                       */
PDS_VERSION_ID      = PDS3
LABEL_REVISION_NOTE = "1998-07-01, Richard Simpson (STANFORD), initial;"
RECORD_TYPE         = STREAM

```

```

OBJECT                                     = TARGET
  TARGET_NAME                             = JUPITER

OBJECT                                     = TARGET_INFORMATION
  TARGET_TYPE                             = PLANET
  PRIMARY_BODY_NAME                       = SUN
  ORBIT_DIRECTION                         = PROGRADE
  ROTATION_DIRECTION                      = PROGRADE
  TARGET_DESC                             = "

A_AXIS_RADIUS                           : 71492.000000
B_AXIS_RADIUS                           : 71492.000000
BOND_ALBEDO                             : UNK
C_AXIS_RADIUS                           : 66854.000000
FLATTENING                              : 0.006500
MAGNETIC_MOMENT                         : 15500000000000000000.000000
MASS                                     : 1898799999999999953652202602496.000000
MASS_DENSITY                           : 1.330000
MINIMUM_SURFACE_TEMPERATURE             : UNK
MAXIMUM_SURFACE_TEMPERATURE             : UNK
MEAN_SURFACE_TEMPERATURE                : UNK
EQUATORIAL_RADIUS                      : 71492.000000
MEAN_RADIUS                             : 69911.000000
SURFACE_GRAVITY                         : 25.900000
REVOLUTION_PERIOD                      : 4333.000000
POLE_RIGHT_ASCENSION                   : 268.000000
POLE_DECLINATION                       : 64.500000
SIDEREAL_ROTATION_PERIOD                : 0.410000
MEAN_SOLAR_DAY                          : 0.410000
OBLIQUITY                               : 3.100000
ORBITAL_ECCENTRICITY                   : 0.048000
ORBITAL_INCLINATION                    : 1.300000
ORBITAL_SEMIMAJOR_AXIS                 : 778376719.000000
ASCENDING_NODE_LONGITUDE                : 100.500000
PERIAPSIS_ARGUMENT_ANGLE               : 275.200000"

END_OBJECT                               = TARGET_INFORMATION

OBJECT                                     = TARGET_REFERENCE_INFORMATION
  REFERENCE_KEY_ID                       = "XYZ95"
END_OBJECT                               = TARGET_REFERENCE_INFORMATION

END_OBJECT                               = TARGET
END

```

## **B.37 TARGET\_INFORMATION**

The TARGET\_INFORMATION object, a sub-object of the TARGET catalog object, provides physical and dynamic parameters of the target.

### **B.37.1 Required Keywords**

1. ORBIT\_DIRECTION
2. PRIMARY\_BODY\_NAME
3. ROTATION\_DIRECTION
4. TARGET\_DESC
5. TARGET\_TYPE

### **B.37.2 Optional Keywords**

None

### **B.37.3 Required Objects**

None

### **B.37.4 Optional Objects**

None

### **B.37.5 Example**

See the example for the TARGET object in Section B.36.5.

## B.38 TARGET\_REFERENCE\_INFORMATION

The TARGET\_REFERENCE\_INFORMATION object, a sub-object of the TARGET catalog object, associates a reference with a target. A separate object must be completed for each reference cited within the TARGET catalog object.

A separate REFERENCE catalog object is completed to provide the associated citation for each reference.

### B.38.1 Required Keywords

#### 1. REFERENCE\_KEY\_ID

Note: If there are no relevant references to cite, the REFERENCE\_KEY\_ID should have a value of "N/A".

### B.38.2 Optional Keywords

None

### B.38.3 Required Objects

None

### B.38.4 Optional Objects

None

### B.38.5 Usage Notes

NOTE: The following are recommended as the minimum set of information needed to describe a target adequately. Additional information may be added as desired. If any of the information not be available or is not known then, consult Chapter 17, Usage of N/A, UNK, and NULL.

```
A_AXIS_RADIUS
B_AXIS_RADIUS
BOND_ALBEDO
C_AXIS_RADIUS
FLATTENING
MAGNETIC_MOMENT
```

MASS  
MASS\_DENSITY  
MINIMUM\_SURFACE\_TEMPERATURE  
MAXIMUM\_SURFACE\_TEMPERATURE  
MEAN\_SURFACE\_TEMPERATURE  
EQUATORIAL\_RADIUS  
MEAN\_RADIUS  
SURFACE\_GRAVITY  
REVOLUTION\_PERIOD  
POLE\_RIGHT\_ASCENSION  
POLE\_DECLINATION  
SIDEREAL\_ROTATION\_PERIOD  
MEAN\_SOLAR\_DAY  
OBLIQUITY  
ORBITAL\_ECCENTRICITY  
ORBITAL\_INCLINATION  
ORBITAL\_SEMIMAJOR\_AXIS  
ASCENDING\_NODE\_LONGITUDE  
PERIAPSIS\_ARGUMENT\_ANGLE

### **B.38.6 Example**

See the example for the TARGET object in Section B.36.5.

**C**

CATALOG directory, B-1

catalog objects, B-1

DATA\_SET, B-4, B-28, B-29

DATA\_SET\_COLL\_ASSOC\_DATA\_SETS, B-11

DATA\_SET\_COLLECTION, B-13

DATA\_SET\_COLLECTION\_INFO, B-16

DATA\_SET\_COLLECTION\_REF\_INFO, B-12

DATA\_SET\_HOST, B-4, B-5, B-18

DATA\_SET\_INFORMATION, B-4, B-19

DATA\_SET\_MAP\_PROJECTION, B-23, B-27

DATA\_SET\_MAP\_PROJECTION\_INFO, B-26

DATA\_SET\_TARGET, B-29

DS\_MAP\_PROJECTION\_REF\_INFO, B-30

IMAGE\_MAP\_PROJECTION, B-31

INSTRUMENT, B-37, B-49

INSTRUMENT\_HOST, B-41, B-43, B-45

INSTRUMENT\_HOST\_INFORMATION, B-41, B-43

INSTRUMENT\_HOST\_REFERENCE\_INFO, B-41, B-45

INSTRUMENT\_INFORMATION, B-37, B-46

INSTRUMENT\_REFERENCE\_INFO, B-37, B-49

INVENTORY, B-50, B-52

INVENTORY\_DATA\_SET\_INFO, B-52, B-53

INVENTORY\_NODE\_MEDIA\_INFO, B-53

MISSION, B-54, B-59, B-60, B-61, B-62

MISSION\_HOST, B-54, B-59, B-63

MISSION\_INFORMATION, B-54, B-60

MISSION\_REFERENCE\_INFORMATION, B-54, B-62

MISSION\_TARGET, B-63

PERSONNEL, B-64, B-66, B-67

PERSONNEL\_ELECTRONIC\_MAIL, B-64, B-66

PERSONNEL\_INFORMATION, B-64, B-67

REFERENCE, B-28, B-68

SOFTWARE, B-75, B-77, B-78

SOFTWARE\_INFORMATION, B-77

SOFTWARE\_ONLINE, B-78

SOFTWARE\_PURPOSE, B-79

TARGET, B-80, B-82, B-83

TARGET\_INFORMATION, B-80, B-82

TARGET\_REFERENCE\_INFORMATION, B-83

CITATION\_DESC, B-21

example, B-5



formation rule, B-21  
CONFIDENCE\_LEVEL\_NOTE  
headings, B-21

<b>D</b>
----------

, B-23

, B-84  
DATA\_SET object, B-18, B-19, B-28, B-29  
definition, B-4  
DATA\_SET\_COLL\_ASSOC\_DATA\_SETS object  
definition, B-11  
DATA\_SET\_COLLECTION object, B-11, B-12, B-16, B-17  
definition, B-13  
DATA\_SET\_COLLECTION\_DESC, B-16  
DATA\_SET\_COLLECTION\_INFO object  
definition, B-16  
headings, B-17  
DATA\_SET\_COLLECTION\_REF\_INFO object  
definition, B-12  
DATA\_SET\_DESC, B-1  
headings, B-20  
subheading formats, B-1  
DATA\_SET\_HOST object  
definition, B-18  
DATA\_SET\_ID, B-52  
DATA\_SET\_INFORMATION object  
definition, B-19  
DATA\_SET\_MAP\_PROJECTION object, B-26, B-31  
definition, B-23  
DATA\_SET\_MAP\_PROJECTION\_INFO object, B-30  
definition, B-26  
DATA\_SET\_REFERENCE\_INFORMATION object, B-4, B-5  
definition, B-28  
DATA\_SET\_TARGET object, B-4, B-5  
definition, B-29  
DATA\_SET\_TERSE\_DESC  
example, B-5  
DS\_MAP\_PROJECTION\_REF\_INFO object  
definition, B-30

**E**

EARTH\_BASE\_ID, B-37

**F**

FORMAT70 program, B-2

**I**

IMAGE\_MAP\_PROJECTION object, B-23

definition, B-31

INSTRUMENT object

definition, B-37

INSTRUMENT\_DESC, B-1

headings, B-46

subheading formats, B-1

INSTRUMENT\_HOST object

definition, B-41

INSTRUMENT\_HOST\_DESC

headings, B-43

INSTRUMENT\_HOST\_ID, B-37

INSTRUMENT\_HOST\_INFORMATION object

definition, B-43

INSTRUMENT\_HOST\_REFERENCE\_INFO object

definition, B-45

INSTRUMENT\_INFORMATION object

definition, B-46

INSTRUMENT\_REFERENCE\_INFO object

definition, B-49

INVENTORY object

definition, B-50

INVENTORY\_DATA\_SET\_INFO object

definition, B-52

INVENTORY\_NODE\_MEDIA\_INFO object

definition, B-53

**L**

LINE\_FIRST\_PIXEL, B-31

LINE\_LAST\_PIXEL, B-31

**M**

MAP\_PROJECTION\_DESC

headings, B-26

MISSION object, B-59, B-60, B-62, B-63  
 definition, B-54  
 MISSION\_DESC  
 headings, B-61  
 MISSION\_HOST object  
 definition, B-59  
 MISSION\_INFORMATION object  
 definition, B-60  
 MISSION\_OBJECTIVES\_SUMMARY  
 headings, B-61  
 MISSION\_REFERENCE\_INFORMATION object  
 definition, B-62  
 MISSION\_TARGET object  
 definition, B-63

<b>O</b>
----------

objects. *See* catalog objects, *See* data objects  
 observing campaign  
 as MISSION, B-54

<b>P</b>
----------

PDS objects. *See* catalog objects, *See* data objects  
 PDS Software Inventory, B-75  
 PDS\_USER\_ID, B-64  
 PERSONNEL object, B-66, B-67  
 PERSONNEL object  
 definition, B-64  
 PERSONNEL\_ELECTRONIC\_MAIL object  
 definition, B-66  
 PERSONNEL\_INFORMATION object  
 definition, B-67

<b>R</b>
----------

REFERENCE object, B-4, B-5, B-12, B-30, B-45, B-49, B-62, B-83  
 definition, B-68  
 REFERENCE\_KEY\_ID, B-5, B-12, B-28, B-30, B-45, B-62, B-83  
 references  
 what to reference, B-68  
 ROTATIONAL\_ELEMENT\_DESC  
 headings, B-26

**S**

SAMPLE\_FIRST\_PIXEL, B-31  
SAMPLE\_LAST\_PIXEL, B-31  
software  
    PDS inventory of tools and libraries, B-75  
SOFTWARE object, B-77, B-78, B-79  
    definition, B-75  
SOFTWARE\_INFORMATION object  
    definition, B-77  
SOFTWARE\_ONLINE object  
    definition, B-78  
SOFTWARE\_PURPOSE object  
    definition, B-79  
SPACECRAFT\_ID, B-37

**T**

TARGET object, B-82, B-83  
    definition, B-80  
TARGET\_INFORMATION object  
    definition, B-82  
TARGET\_REFERENCE\_INFORMATION object, B-80  
    definition, B-83

# Appendix C. Internal Representation of Data Types

This appendix contains the detailed internal representations of the PDS standard data types listed in Table 3.2 of the *Data Type Definitions* chapter of this document.

## Chapter Contents

Appendix C.	Internal Representation of Data Types.....	C-1
C.1	MSB_INTEGER.....	C-2
C.2	MSB_UNSIGNED_INTEGER.....	C-4
C.3	LSB_INTEGER.....	C-6
C.4	LSB_UNSIGNED_INTEGER.....	C-8
C.5	IEEE_REAL.....	C-10
C.6	IEEE_COMPLEX.....	C-13
C.7	PC_REAL.....	C-14
C.8	PC_COMPLEX.....	C-17
C.9	VAX_REAL, VAXG_REAL.....	C-18
C.10	VAX_COMPLEX, VAXG_COMPLEX.....	C-22
C.11	MSB_BIT_STRING.....	C-23
C.12	LSB_BIT_STRING.....	C-25

## C.1 MSB\_INTEGER

**Aliases:** INTEGER  
MAC\_INTEGER  
SUN\_INTEGER

This section describes the signed integers stored in Most Significant Byte first (MSB) order. In this section the following definitions apply:

- b0 – b3* Arrangement of bytes as they appear when read from a file (e.g., read *b0* first, then *b1*, *b2*, and *b3*)
- i-sign* Integer sign bit (bit 7 in the highest-order byte)
- i0 – i3* Arrangement of bytes in the integer, from lowest order to highest order. The bits within each byte are interpreted from right to left (e.g., lowest value = bit 0, highest value = bit 7) in the following way:

4-byte integers:

- In *i0*, bits 0-7 represent  $2^{**0}$  through  $2^{**7}$
- In *i1*, bits 0-7 represent  $2^{**8}$  through  $2^{**15}$
- In *i2*, bits 0-7 represent  $2^{**16}$  through  $2^{**23}$
- In *i3*, bits 0-6 represent  $2^{**24}$  through  $2^{**30}$

2-byte integers:

- In *i0*, bits 0-7 represent  $2^{**0}$  through  $2^{**7}$
- In *i1*, bits 0-6 represent  $2^{**8}$  through  $2^{**14}$

1-byte integers:

- In *i0*, bits 0-6 represent  $2^{**0}$  through  $2^{**6}$

Negative integers are represented in two's complement.

### C.1.1 MSB 4-byte Integer

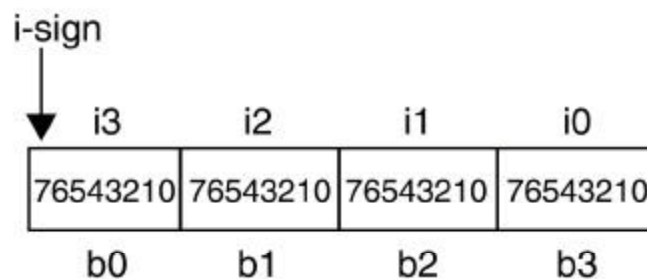

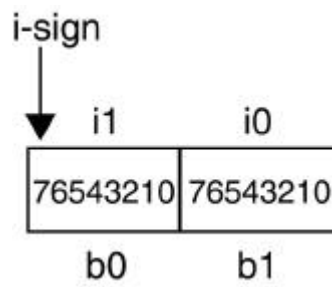
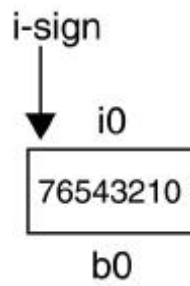
**C.1.2 MSB 2-byte Integer****C.1.3 MSB 1-byte Integer**

## C.2 MSB\_UNSIGNED\_INTEGER

**Aliases:** UNSIGNED\_INTEGER  
 MAC\_UNSIGNED\_INTEGER  
 SUN\_UNSIGNED\_INTEGER

This section describes unsigned integers stored in Most Significant Byte first (MSB) format. In this section the following definitions apply:

$b0 - b3$  Arrangement of bytes as they appear when read from a file (e.g., read  $b0$  first, then  $b1$ ,  $b2$  and  $b3$ )

$i0 - i3$  Arrangement of bytes in the integer, from lowest order to highest order. The bits within each byte are interpreted from right to left (e.g., lowest value = bit 0, highest value = bit 7), in the following way:

4-bytes:

In  $i0$ , bits 0-7 represent  $2^{**0}$  through  $2^{**7}$

In  $i1$ , bits 0-7 represent  $2^{**8}$  through  $2^{**15}$

In  $i2$ , bits 0-7 represent  $2^{**16}$  through  $2^{**23}$

In  $i3$ , bits 0-7 represent  $2^{**24}$  through  $2^{**31}$

2-bytes:

In  $i0$ , bits 0-7 represent  $2^{**0}$  through  $2^{**7}$

In  $i1$ , bits 0-7 represent  $2^{**8}$  through  $2^{**15}$

1-byte:

In  $i0$ , bits 0-7 represent  $2^{**0}$  through  $2^{**7}$

### C.2.1 MSB 4-byte Unsigned Integers

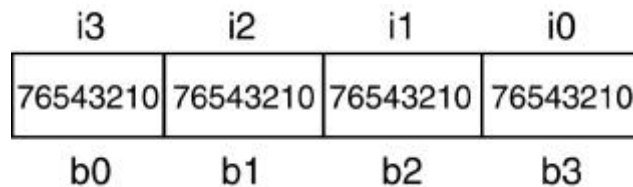

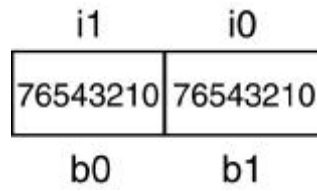
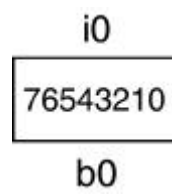

**C.2.2 MSB 2-byte Unsigned Integers****C.2.3 MSB 1-byte Unsigned Integers**

## C.3 LSB\_INTEGER

**Aliases:** PC\_INTEGER  
VAX\_INTEGER

This section describes signed integers stored in Least Significant Byte first (LSB) order. In this section the following definitions apply:

*b0 – b3* Arrangement of bytes as they appear when reading a file (e.g., read byte b0 first, then b1, b2 and b3)

*i-sign* Integer sign bit – bit 7 in the highest order byte

*i0 – i3* Arrangement of bytes in the integer, from lowest order to highest order. The bits within each byte are interpreted from right to left (e.g., lowest value = bit 0, highest value = bit 7), in the following way:

4-bytes:

- In *i0*, bits 0-7 represent  $2^{**0}$  through  $2^{**7}$
- In *i1*, bits 0-7 represent  $2^{**8}$  through  $2^{**15}$
- In *i2*, bits 0-7 represent  $2^{**16}$  through  $2^{**23}$
- In *i3*, bits 0-6 represent  $2^{**24}$  through  $2^{**30}$

2-bytes:

- In *i0*, bits 0-7 represent  $2^{**0}$  through  $2^{**7}$
- In *i1*, bits 0-6 represent  $2^{**8}$  through  $2^{**14}$

1-byte:

- In *i0*, bits 0-6 represent  $2^{**0}$  through  $2^{**6}$

All negative values are represented in two's complement.

### C.3.1 LSB 4-byte Integers

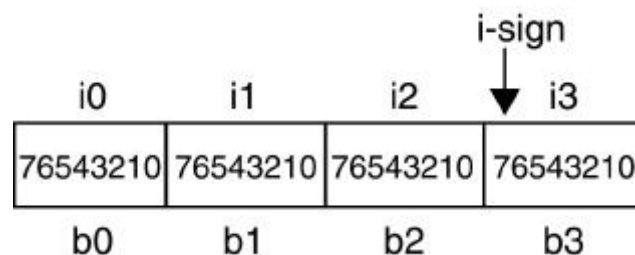

### C.3.2 LSB 2-byte Integers

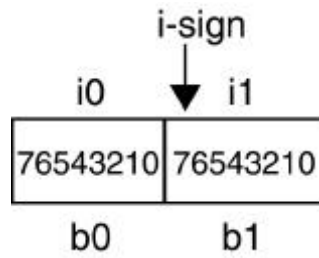

### C.3.3 LSB 1-byte Integers

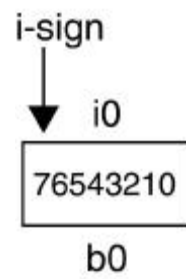

## C.4 LSB\_UNSIGNED\_INTEGER

**Aliases:** PC\_UNSIGNED\_INTEGER  
VAX\_UNSIGNED\_INTEGER

This section describes unsigned integers stored in Least Significant Byte first (LSB) format. In this section the following definitions apply:

*b0 – b3* Arrangement of bytes as they appear when reading a file (e.g., read byte b0 first, then b1, b2 and b3)

*i0 – i3* Arrangement of bytes in the integer, from lowest order to highest order. The bits within each byte are interpreted from right to left (e.g., lowest value = bit 0, highest value = bit 7), in the following way:

4-bytes:

In *i0*, bits 0-7 represent  $2^{**0}$  through  $2^{**7}$

In *i1*, bits 0-7 represent  $2^{**8}$  through  $2^{**15}$

In *i2*, bits 0-7 represent  $2^{**16}$  through  $2^{**23}$

In *i3*, bits 0-7 represent  $2^{**24}$  through  $2^{**31}$

2-bytes:

In *i0*, bits 0-7 represent  $2^{**0}$  through  $2^{**7}$

In *i1*, bits 0-7 represent  $2^{**8}$  through  $2^{**15}$

1-byte:

In *i0*, bits 0-7 represent  $2^{**0}$  through  $2^{**7}$

### C.4.1 LSB 4-byte Unsigned Integers

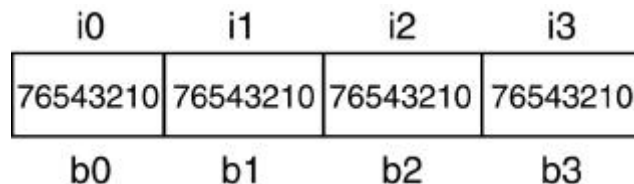

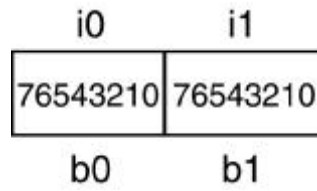
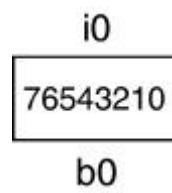
**C.4.2 LSB 2-byte Unsigned Integers****C.4.3 LSB 1-byte Unsigned Integers**

## C.5 IEEE\_REAL

**Aliases:** FLOAT  
 REAL  
 MAC\_REAL  
 SUN\_REAL

This section describes the internal format of IEEE-format floating-point numbers. In this section the following definitions apply:

<i>b0 – b9</i>	Arrangement of bytes as they appear when read from a file (e.g., read b0 first, then b1, b2, b3, etc.)
<i>m-sign</i>	Mantissa sign bit
<i>int-bit</i>	In 10-byte real format only, the integer part of the mantissa, assumed to be “1” in other formats, is explicitly indicated by this bit
<i>e0 – e1</i>	Arrangement of the portions of the bytes that make up the exponent, from lowest order to highest order. The bits within each byte are interpreted from right to left (e.g., lowest value = rightmost bit in the exponent part of the byte, highest value = leftmost bit in the exponent part of the byte) in the following way: <ul style="list-style-type: none"> <li>10-bytes (temporary):           <ul style="list-style-type: none"> <li>In e0, bits 0-7 represent <math>2^{**0}</math> through <math>2^{**7}</math></li> <li>In e1, bits 0-6 represent <math>2^{**8}</math> through <math>2^{**14}</math></li> </ul> </li> <li>Exponent bias = 16383</li> <li>8-bytes (double precision):           <ul style="list-style-type: none"> <li>In e0, bits 4-7 represent <math>2^{**0}</math> through <math>2^{**3}</math></li> <li>In e1, bits 0-6 represent <math>2^{**4}</math> through <math>2^{**10}</math></li> </ul> </li> <li>Exponent bias = 1023</li> <li>4-bytes (single precision):           <ul style="list-style-type: none"> <li>In e0, bit 7 represent <math>2^{**0}</math></li> <li>In e1, bits 0-6 represent <math>2^{**1}</math> through <math>2^{**7}</math></li> </ul> </li> <li>Exponent bias = 127</li> </ul>

$m0 - m7$  Arrangement of the portions of the bytes that make up the mantissa, from highest order fractions to the lowest order fraction. The order of the bits within each byte progresses from left to right, with each bit representing a fractional power of two, in the following way:

10-bytes (temporary):

In  $m0$ , bits 6-0 represent  $1/2^{**1}$  through  $1/2^{**7}$   
 In  $m1$ , bits 7-0 represent  $1/2^{**8}$  through  $1/2^{**15}$   
 In  $m2$ , bits 7-0 represent  $1/2^{**16}$  through  $1/2^{**23}$   
 In  $m3$ , bits 7-0 represent  $1/2^{**24}$  through  $1/2^{**31}$   
 In  $m4$ , bits 7-0 represent  $1/2^{**32}$  through  $1/2^{**39}$   
 In  $m5$ , bits 7-0 represent  $1/2^{**40}$  through  $1/2^{**47}$   
 In  $m6$ , bits 7-0 represent  $1/2^{**48}$  through  $1/2^{**55}$   
 In  $m7$ , bits 7-0 represent  $1/2^{**56}$  through  $1/2^{**63}$

8-bytes (double precision):

In  $m0$ , bits 3-0 represent  $1/2^{**1}$  through  $1/2^{**4}$   
 In  $m1$ , bits 7-0 represent  $1/2^{**5}$  through  $1/2^{**12}$   
 In  $m2$ , bits 7-0 represent  $1/2^{**13}$  through  $1/2^{**20}$   
 In  $m3$ , bits 7-0 represent  $1/2^{**21}$  through  $1/2^{**28}$   
 In  $m4$ , bits 7-0 represent  $1/2^{**29}$  through  $1/2^{**36}$   
 In  $m5$ , bits 7-0 represent  $1/2^{**37}$  through  $1/2^{**44}$   
 In  $m6$ , bits 7-0 represent  $1/2^{**45}$  through  $1/2^{**52}$

4-bytes (single precision):

In  $m0$ , bits 6-0 represent  $1/2^{**1}$  through  $1/2^{**7}$   
 In  $m1$ , bits 7-0 represent  $1/2^{**8}$  through  $1/2^{**15}$   
 In  $m2$ , bits 7-0 represent  $1/2^{**16}$  through  $1/2^{**23}$

The following representations all follow this format:

$$1.\textit{mantissa} ? 2^{**}(\textit{exponent} - \textit{bias})$$

Note that the integer part (“1.”) is implicit in all formats except the 10-byte (temporary) real format, as described above. In all cases the exponent is stored as an unsigned, biased integer (that is, the stored exponent value – bias value = true exponent).

### C.5.1 IEEE 10-byte (Temporary) Real Numbers

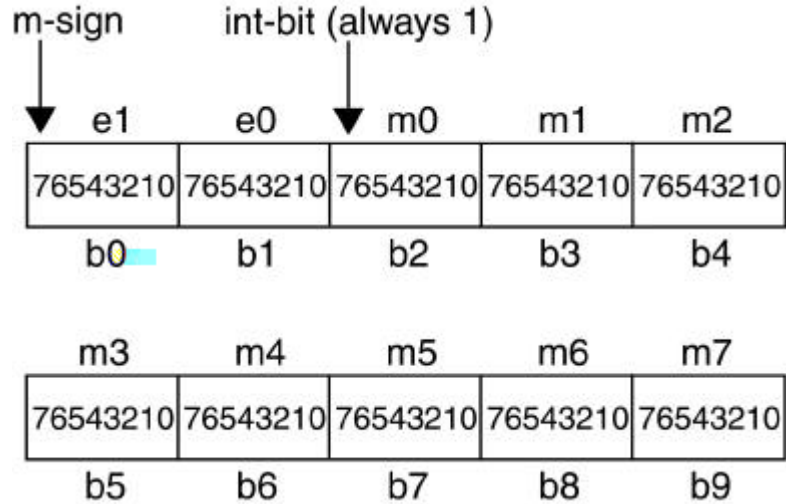

### C.5.2 IEEE 8-byte (Double Precision) Real Numbers

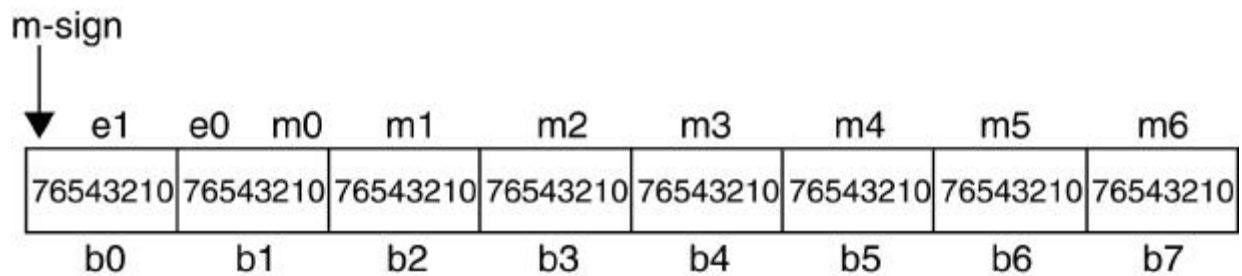

### C.5.3 IEEE 4-byte (Single Precision) Real Numbers

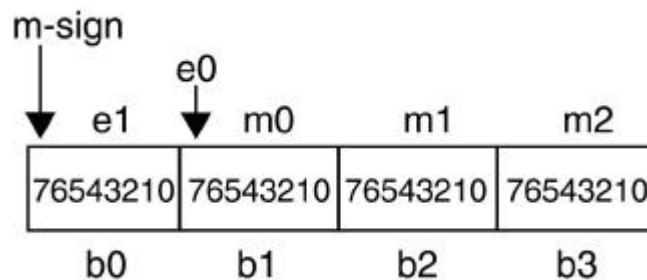



## C.6 IEEE\_COMPLEX

**Aliases:** COMPLEX  
MAC\_COMPLEX  
SUN\_COMPLEX

IEEE complex numbers consist of two IEEE\_REAL format numbers of the same precision, contiguous in memory. The first number represents the real part and the second the imaginary part of the complex value.

For more information on using IEEE\_REAL formats, see Section C.5.

## C.7 PC\_REAL

**Aliases:** None

This section describes the internal storage format corresponding to the PC\_REAL data type. In this section the following definitions apply:

<i>b0 – b9</i>	Arrangement of bytes as they appear when read from a file (e.g., read b0 first, then b1, b2 and b3)
<i>m-sign</i>	Mantissa sign bit
<i>int-bit</i>	In 10-byte real format only, the integer part of the mantissa, assumed to be “1” in other formats, is explicitly indicated by this bit.
<i>e0 – e1</i>	<p>Arrangement of the portions of the bytes that make up the exponent, from lowest order to highest order. The bits within each byte are interpreted from right to left (e.g., lowest value = rightmost bit in the exponent part of the byte, highest value = leftmost bit in the exponent part of the byte) in the following way:</p> <p>10-bytes (temporary):            In e0, bits 0-7 represent <math>2^{**0}</math> through <math>2^{**7}</math>            In e1, bits 0-6 represent <math>2^{**8}</math> through <math>2^{**14}</math></p> <p>Exponent bias = 16383</p> <p>8-bytes (double precision):            In e0, bits 4-7 represent <math>2^{**0}</math> through <math>2^{**3}</math>            In e1, bits 0-6 represent <math>2^{**4}</math> through <math>2^{**10}</math></p> <p>Exponent bias = 1023</p> <p>4-bytes (single precision):            In e0, bit 7 represent <math>2^{**0}</math>            In e1, bits 0-6 represent <math>2^{**1}</math> through <math>2^{**7}</math></p> <p>Exponent bias = 127</p>
<i>m0 – m7</i>	<p>Arrangement of the portions of the bytes that make up the mantissa, from highest order fractions to the lowest order fraction. The order of the bits within each byte progresses from left to right, with each bit representing a fractional power of two, in the following way:</p> <p>10-bytes (temporary):</p>

In m0, bits 6-0 represent  $1/2^{**1}$  through  $1/2^{**7}$   
 In m1, bits 7-0 represent  $1/2^{**8}$  through  $1/2^{**15}$   
 In m2, bits 7-0 represent  $1/2^{**16}$  through  $1/2^{**23}$   
 In m3, bits 7-0 represent  $1/2^{**24}$  through  $1/2^{**31}$   
 In m4, bits 7-0 represent  $1/2^{**32}$  through  $1/2^{**39}$   
 In m5, bits 7-0 represent  $1/2^{**40}$  through  $1/2^{**47}$   
 In m6, bits 7-0 represent  $1/2^{**48}$  through  $1/2^{**55}$   
 In m7, bits 7-0 represent  $1/2^{**56}$  through  $1/2^{**63}$

8-bytes (double precision):

In m0, bits 3-0 represent  $1/2^{**1}$  through  $1/2^{**4}$   
 In m1, bits 7-0 represent  $1/2^{**5}$  through  $1/2^{**12}$   
 In m2, bits 7-0 represent  $1/2^{**13}$  through  $1/2^{**20}$   
 In m3, bits 7-0 represent  $1/2^{**21}$  through  $1/2^{**28}$   
 In m4, bits 7-0 represent  $1/2^{**29}$  through  $1/2^{**36}$   
 In m5, bits 7-0 represent  $1/2^{**37}$  through  $1/2^{**44}$   
 In m6, bits 7-0 represent  $1/2^{**45}$  through  $1/2^{**52}$

4-bytes (single precision):

In m0, bits 6-0 represent  $1/2^{**1}$  through  $1/2^{**7}$   
 In m1, bits 7-0 represent  $1/2^{**8}$  through  $1/2^{**15}$   
 In m2, bits 7-0 represent  $1/2^{**16}$  through  $1/2^{**23}$

The following representations all follow this format:

$$1.\textit{mantissa} ? 2^{**}(\textit{exponent} - \textit{bias})$$

Note that the integer part (“1.”) is implicit in all formats except the 10-byte (temporary) real format, as described above. In all cases the exponent is stored as an unsigned, biased integer (that is, the stored exponent value – bias value = true exponent).

### C.7.1 PC 10-byte (Temporary) Real Numbers

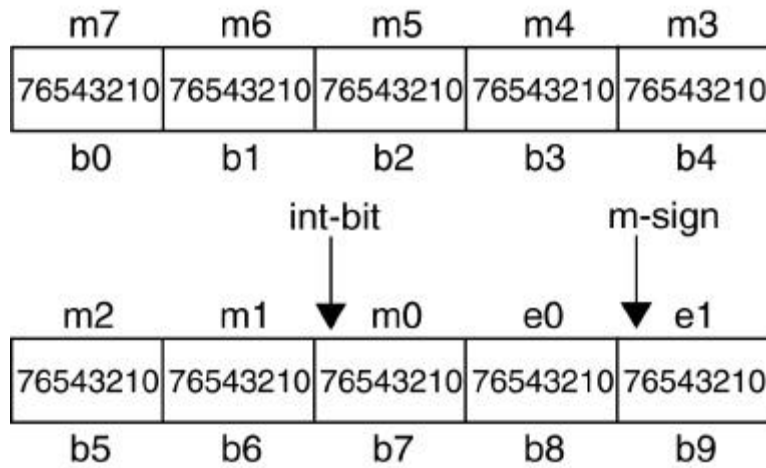

### C.7.2 PC 8-byte (Double Precision) Real Numbers

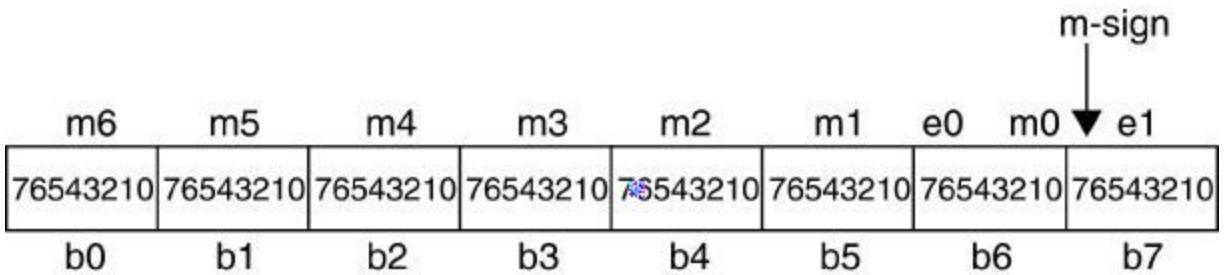

### C.7.3 PC 4-byte (Single Precision) Real Numbers

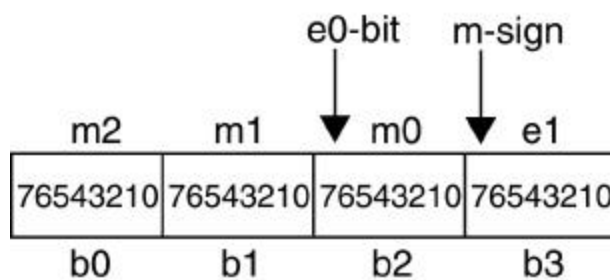

## C.8 PC\_COMPLEX

**Aliases:** None

PC complex numbers consist of two PC\_REAL format numbers of the same precision, contiguous in memory. The first number represents the real part and the second the imaginary part of the complex value.

For more information on using PC\_REAL formats, see Section C.7.

## C.9 VAX\_REAL, VAXG\_REAL

**Aliases:** VAX\_DOUBLE for VAX\_REAL only.

No aliases for VAXG\_REAL

This section describes the internal format corresponding to the VAX\_REAL and VAXG\_REAL data types. In this section the following definitions apply:

<i>b0 – b15</i>	Arrangement of bytes as they appear when read from a file (e.g., read b0 first, then b1, b2 and b3)
<i>m-sign</i>	Mantissa sign bit
<i>e0 – e1</i>	Arrangement of the portions of the bytes that make up the exponent, from lowest order to highest order. The bits within each byte are interpreted from right to left (e.g., lowest value = rightmost bit in the exponent part of the byte, highest value = leftmost bit in the exponent part of the byte) in the following way: <ul style="list-style-type: none"> <li>16-bytes (H-type, quad precision):             <ul style="list-style-type: none"> <li>In e0, bits 0-7 represent <math>2^{**0}</math> through <math>2^{**7}</math></li> <li>In e1, bits 0-6 represent <math>2^{**8}</math> through <math>2^{**14}</math></li> </ul> <p style="margin-left: 40px;">Exponent bias = 16385</p> </li> <li>8-bytes (G-type, double precision):             <ul style="list-style-type: none"> <li>In e0, bits 4-7 represent <math>2^{**0}</math> through <math>2^{**3}</math></li> <li>In e1, bits 0-6 represent <math>2^{**4}</math> through <math>2^{**10}</math></li> </ul> <p style="margin-left: 40px;">Exponent bias = 1025</p> </li> <li>8-bytes (D-type, double precision):             <ul style="list-style-type: none"> <li>In e0, bit 7 represents <math>2^{**0}</math></li> <li>In e1, bits 0-6 represent <math>2^{**1}</math> through <math>2^{**7}</math></li> </ul> <p style="margin-left: 40px;">Exponent bias = 129</p> </li> <li>4-bytes (F-type, single precision):             <ul style="list-style-type: none"> <li>In e0, bit 7 represent <math>2^{**0}</math></li> <li>In e1, bits 0-6 represent <math>2^{**1}</math> through <math>2^{**7}</math></li> </ul> <p style="margin-left: 40px;">Exponent bias = 129</p> </li> </ul>

*m0 – m13* Arrangement of the portions of the bytes that make up the mantissa, from highest order fractions to the lowest order fraction. The order of the bits within each byte progresses from left to right, with each bit representing a fractional power of two, in the following way:

16-bytes (H-type, quad precision):

- In *m0*, bits 7-0 represent  $1/2^{**1}$  through  $1/2^{**8}$
- In *m1*, bits 7-0 represent  $1/2^{**9}$  through  $1/2^{**16}$
- In *m2*, bits 7-0 represent  $1/2^{**17}$  through  $1/2^{**24}$
- In *m3*, bits 7-0 represent  $1/2^{**25}$  through  $1/2^{**32}$
- In *m4*, bits 7-0 represent  $1/2^{**33}$  through  $1/2^{**40}$
- In *m5*, bits 7-0 represent  $1/2^{**41}$  through  $1/2^{**48}$
- In *m6*, bits 7-0 represent  $1/2^{**49}$  through  $1/2^{**56}$
- In *m7*, bits 7-0 represent  $1/2^{**57}$  through  $1/2^{**64}$
- In *m8*, bits 7-0 represent  $1/2^{**65}$  through  $1/2^{**72}$
- In *m9*, bits 7-0 represent  $1/2^{**73}$  through  $1/2^{**80}$
- In *m10*, bits 7-0 represent  $1/2^{**81}$  through  $1/2^{**88}$
- In *m11*, bits 7-0 represent  $1/2^{**89}$  through  $1/2^{**96}$
- In *m12*, bits 7-0 represent  $1/2^{**97}$  through  $1/2^{**104}$
- In *m13*, bits 7-0 represent  $1/2^{**105}$  through  $1/2^{**112}$

8-bytes (G-type, double precision):

- In *m0*, bits 3-0 represent  $1/2^{**1}$  through  $1/2^{**4}$
- In *m1*, bits 7-0 represent  $1/2^{**5}$  through  $1/2^{**12}$
- In *m2*, bits 7-0 represent  $1/2^{**13}$  through  $1/2^{**20}$
- In *m3*, bits 7-0 represent  $1/2^{**21}$  through  $1/2^{**28}$
- In *m4*, bits 7-0 represent  $1/2^{**29}$  through  $1/2^{**36}$
- In *m5*, bits 7-0 represent  $1/2^{**37}$  through  $1/2^{**44}$
- In *m6*, bits 7-0 represent  $1/2^{**45}$  through  $1/2^{**52}$

8-bytes (D-type, double precision):

- In *m0*, bits 6-0 represent  $1/2^{**1}$  through  $1/2^{**7}$
- In *m1*, bits 7-0 represent  $1/2^{**8}$  through  $1/2^{**15}$
- In *m2*, bits 7-0 represent  $1/2^{**16}$  through  $1/2^{**23}$
- In *m3*, bits 7-0 represent  $1/2^{**24}$  through  $1/2^{**31}$
- In *m4*, bits 7-0 represent  $1/2^{**32}$  through  $1/2^{**39}$
- In *m5*, bits 7-0 represent  $1/2^{**40}$  through  $1/2^{**47}$
- In *m6*, bits 7-0 represent  $1/2^{**48}$  through  $1/2^{**55}$

4-bytes (F-type, single precision):

- In *m0*, bits 6-0 represent  $1/2^{**1}$  through  $1/2^{**7}$
- In *m1*, bits 7-0 represent  $1/2^{**8}$  through  $1/2^{**15}$
- In *m2*, bits 7-0 represent  $1/2^{**16}$  through  $1/2^{**23}$

The following representations all follow this format:

$$1.\textit{mantissa} ? 2^{**}(\textit{exponent} - \textit{bias})$$

Note that the integer part (“1.”) is implicit in all formats except the 10-byte (temporary) real format, as described above. In all cases the exponent is stored as an unsigned, biased integer (that is, the stored exponent value – bias value = true exponent).

### C.9.1 VAX 16-byte H-type (Quad Precision) Real Numbers

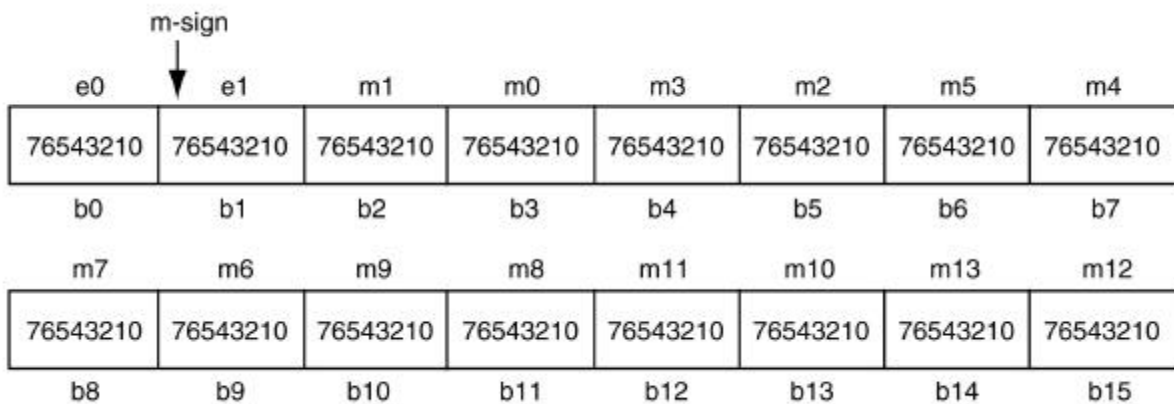

### C.9.2 VAX 8-byte G-type (Double Precision) Real Numbers

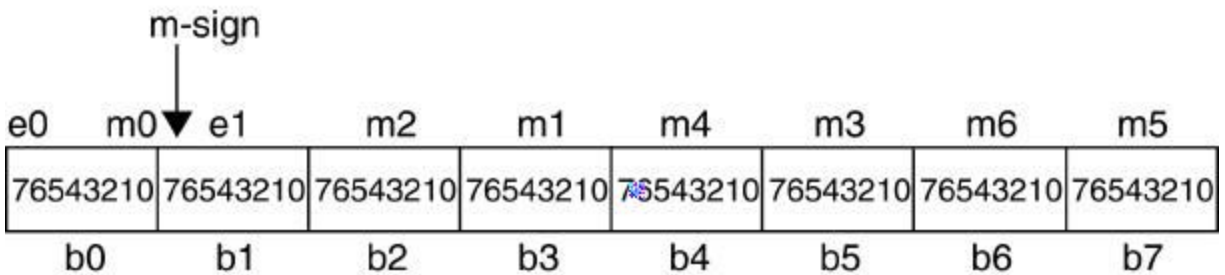



### C.9.3 VAX 8-byte D-type (Double Precision) Real Numbers

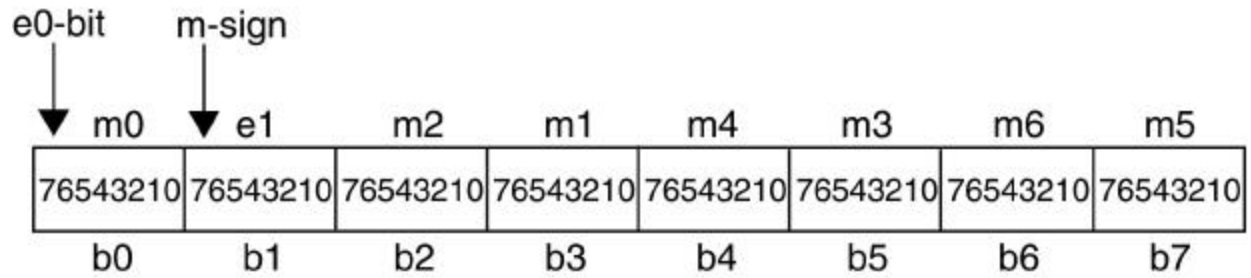

### C.9.4 VAX 4-byte F-type (Single Precision) Real Numbers

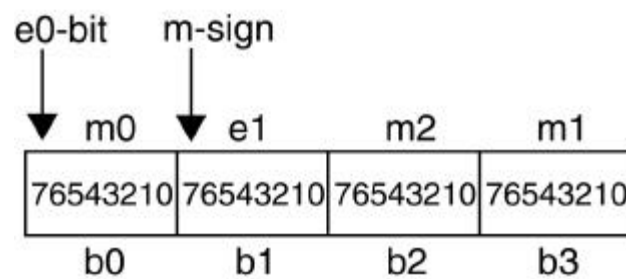

## C.10 VAX\_COMPLEX, VAXG\_COMPLEX

**Aliases:** None

VAX complex numbers consist of two VAX\_REAL (or VAXG\_REAL) format numbers of the same precision, contiguous in memory. The first number represents the real part and the second the imaginary part of the complex value.

For more information on using VAX\_REAL formats, see Section C.9.

## C.11 MSB\_BIT\_STRING

**Aliases:** None

This section describes the storage format for bit strings stored in Most Significant Byte first (MSB) format. In this section the following definitions apply:

$b0 - b3$  Arrangement of bytes as they appear when read from a file (e.g., read  $b0$  first, then  $b1$ ,  $b2$  and  $b3$ )

The bits within a byte are numbered from left to right, as shown below:

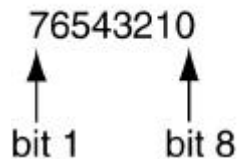

Note that in the case of MSB bit strings, no byte-swapping is required. That is, the physical storage order of the bytes is identical to the logical order.

### C.11.1 MSB $n$ -byte Bit Strings

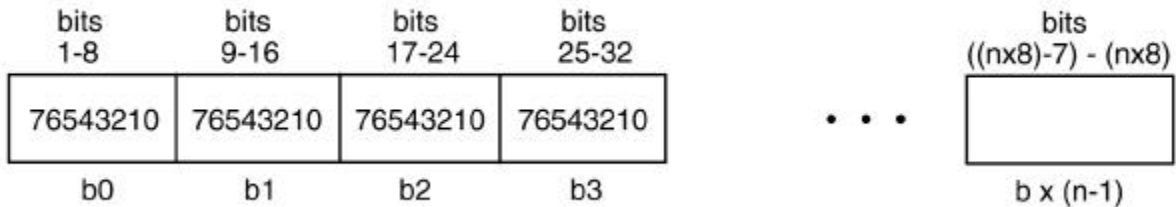

### C.11.2 MSB 2-byte Bit String

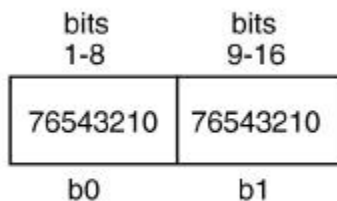

### C.11.3 MSB 1-byte Bit String

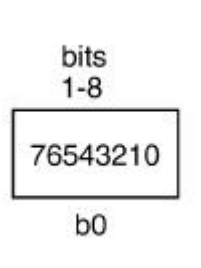

## C.12 LSB\_BIT\_STRING

**Aliases:** VAX\_BIT\_STRING

This section describes the structure of bit strings stored in Least Significant Byte first (LSB) order. In this section, the following definitions apply:

*b0 – b3*      Arrangement of bytes as they appear when read from a file (e.g., read b0 first, then b1, b2 and b3)

The bits within a byte are numbered from left to right, as shown below:

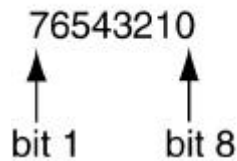

Note that for LSB bit strings byte-swapping is required to convert the storage order of bytes to the logical order.

### C.12.1 LSB 4-byte Bit String

### C.12.2 LSB 2-byte Bit String

Physical order (as read from the file):

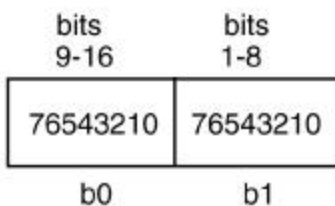

Logical order (after byte-swapping):

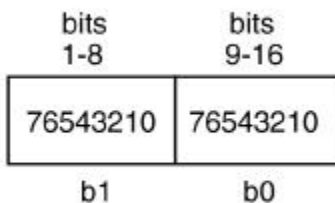

### C.12.3 LSB 1-byte Bit String

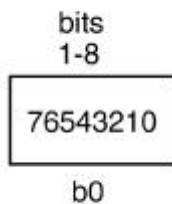

Note that in this degenerate case no byte-swapping is required.

# Appendix D. Examples of Required Files

The examples in this Appendix are based on existing or planned PDS archive volumes, and have been modified to reflect the most recent version of the PDS standards.

## Chapter Contents

<a href="#">Appendix D. Examples of Required Files</a> .....	D-1
<a href="#">D.1 AAREADME.TXT</a> .....	D-2
<a href="#">D.2 INDXINFO.TXT</a> .....	D-8
<a href="#">D.3 SOFTINFO.TXT</a> .....	D-9
<a href="#">D.4 VOLDESC.CAT</a> .....	D-13

## **D.1 AAREADME.TXT**

Each PDS archive volume shall include an “AAREADME.TXT ” file that contains an overview of the contents and structure of the volume. An annotated outline is provided here as guidance for compiling this file.

### **D.1.1 Annotated Outline**

- I. PDS TEXT Object (must appear in an attached or detached label)
- II. Volume Title
- III. Contents
  1. Introduction
    - a. Science data content
    - b. Conformance to PDS standards
    - c. Document or institutional references for additional science information
  2. Volume format
    - a. Computer systems that can access the volume
    - b. International standards to which the volume conforms
  3. File formats
    - a. Data record formats
    - b. Specifications for specialized files (e.g., Postscript)
    - c. Description of PDS objects, pointers, etc.
  4. Volume contents
    - a. Directory structure of the volume
  5. Recommended CD-ROM drives (if applicable)
    - a. Driver descriptions and notes for all appropriate computer platforms
  6. Errata (if applicable)
    - a. Known errors, cautionary notes, disclaimers, etc.
    - b. Reference to the ERRATA.TXT file on the volume or online
  7. Contacts
    - a. Names and addresses of people or organizations to contact for questions concerning science data , technical support, data product generation and labelling, etc.



## D.1.2 Example

The following is an example of an AAREADME.TXT file used on a PDS archive volume that does not use the logical volume construct. Note that section 3 in the example would need to be updated if logical volumes were present.

```

PDS_VERSION_ID           = PDS3
RECORD_TYPE              = FIXED_LENGTH
RECORD_BYTES             = 80
SPACECRAFT_NAME         = MAGELLAN
TARGET_NAME              = VENUS
OBJECT                   = TEXT
  PUBLICATION_DATE      = 1994-06-01
  NOTE                   = "MAGELLAN LOSAPDR ARCHIVE CD-WO"
END_OBJECT               = TEXT
END

```

MAGELLAN LOSAPDR ARCHIVE CD-WO

### 1. Introduction

This CD-WO contains Magellan Cycle 4 LOSAPDR (Line of Sight Acceleration Profile Data Record) products. It also contains documentation which describe the LOSAPDRs. Each LOSAPDR product contains the results from processing of radio tracking data of the Magellan spacecraft. There are 866 LOSAPDRs on this volume.

The LOSAPDR products archived on this volume are the exact products released by the Magellan Project. Supporting documentation and label files conform to the Planetary Data System (PDS) Standards, Version 3.0, Jet Propulsion Laboratory (JPL) document JPL D-7669.

Additional information about the Magellan gravity experiment, including the acquisition, processing, and quality of the LOSAPDR data, can be found in JPL documents that are available from the PDS Geosciences Node, Washington University, St. Louis, MO.

### 2. Disk Format

The disk has been formatted so that a variety of computer systems (e.g. IBM PC, Macintosh, Sun) may access the data. Specifically, it is formatted according to the ISO 9660 level 1 Interchange Standard. For further information, refer to the ISO 9660 Standard Document: RF# ISO 9660-1988, 15 April 1988.

### 3. File Formats

Each orbit for which gravity data exists is represented by one LOSAPDR data file. The LOSAPDR is an ASCII file. The data file contains 3 tables: 1) HEADER\_TABLE; 2) TIMES\_TABLE; and 3) RESULTS\_TABLE. The HEADER\_TABLE is a single-row multi-column table containing information on initial values, control parameters, and simple calculations required by the program that generates the data files. The TIMES\_TABLE is a single column containing exact times bounding spline intervals to the Doppler residuals. The number of rows is variable. The RESULTS\_TABLE contains the results from spline fits to Doppler residuals. Each row in the table contains times, Doppler residuals, spacecraft position and velocity information, and inferred spacecraft acceleration. The data files are described by PDS labels embedded at the beginning of the file. Further information on LOSAPDR file formats and contents can also be obtained from the Magellan Software Interface Specification (SIS) document NAV-138. A copy of the document is stored on this disk as file LOSAPDR.TXT in the DOCUMENT directory.

All document files and detached label files contain 80-byte fixed-length records, with a carriage return character (ASCII 13) in the 79th byte and a line feed character (ASCII 10) in the 80th byte. This allows the files to be read by the MacOS, DOS, Unix, and VMS operating systems. All tabular files are also described by PDS labels, either embedded at the beginning of the file or detached. If detached, the PDS label file has the same name as the data file it describes, with the extension .LBL; for example, the file INDEX.TAB is accompanied by the detached label file INDEX.LBL in the same directory.

Tabular files are formatted so that they may be read directly into many database management systems on various computers. All fields are separated by commas, and character fields are enclosed in double quotation marks ("). Character fields are left justified, and numeric

fields are right justified. The "start byte" and "bytes" values listed in the labels do not include the commas between fields or the quotation marks surrounding character fields. The records are of fixed length, and the last two bytes of each record contain the ASCII carriage return and line feed characters. This allows a table to be treated as a fixed length record file on computers that support this file type and as a normal text file on other computers.

A PostScript file, REPORT.PS, is included on this volume. This PostScript document is a validation report that lists all LOSAPDRs, and gives specific information, comments, and the status of each data file after a quality check and validation at the PDS Geophysics Subnode. The document is described by the detached label file, REPORT.LBL. The document can also be viewed by a Display PostScript program and can be printed out from a PostScript printer. The ASCII text version of the PostScript file is REPORT.ASC.

PDS labels are object-oriented. The object to which the label refers (e.g., IMAGE, TABLE, etc.) is denoted by a statement of the form:

```
^object = location
```

in which the carat character (^, also called a pointer in this context) indicates that the object starts at the given location. In an attached label, the location is an integer representing the starting record number of the object (the first record in the file is record 1). In a detached label, the location denotes the name of the file containing the object, along with the starting record or byte number. For example:

```
^TABLE = "INDEX.TAB"
```

indicates that the TABLE object points to the file INDEX.TAB .

Pointers to data objects are always required to be located in the same directory as the label file, so the file INDEX.TAB in this example is located in the same directory as the detached label file.

Other types of pointer statements can also be found on this volume. To resolve the pointer statement, first look in the same directory as the file containing the pointer statement. If the pointer is still unresolved, look in the following top level directory:

```
^ STRUCTURE - LABEL directory
^ CATALOG - CATALOG directory
^DATA_SET_MAP_PROJECTION - CATALOG directory
^DESCRIPTION - DOCUMENT directory.
```

Below is a list of the possible formats for the ^object keyword.

```
^object = n
^object = n<BYTES>
^object = "filename.ext"
^object = ("filename.ext",n)
^object = ("filename.ext",n<BYTES>)
```

where

```
n          is the starting record or byte number of the object,
           counting from the beginning of the file (record 1,
           byte 1)
<BYTES>   indicates that the number given is in units of bytes
filename   is the upper-case file name
ext        is the upper-case file extension
```

#### 4. CD-ROM Contents

The files on this CD-ROM are organized in one top-level directory with several subdirectories. The following table shows the structure and content of these directories. In the table, directory names are enclosed in square brackets ([ ]), upper-case letters indicate an actual directory or file name, and lower-case letters indicate the general form of a set of directory or file names.

FILE	CONTENTS
Top-level directory	
- AAREADME.TXT	The file you are reading.
- ERRATA.TXT	Description of known anomalies and errors present on this volume.
- VOLDESC.CAT	A description of the contents of this CD-

```

|
| ROM volume in a format readable
| by both humans and computers.
|- [CATALOG] A directory containing information about the
| LOSAPDR dataset.
|   |- CATALOG.CAT PDS catalog objects. Mission, spacecraft
|   | and instrument descriptions.
|   |- CATINFO.TXT Description of files in the CATALOG
|   | directory.
|   |- DATASET.CAT PDS dataset catalog object. A description
|   | of the dataset, parameters, processing, data
|   | coverage and quality.
|- [DATA] A directory containing LOSAPDR data files.
|   |- [mmmmnnnn] Directories containing LOSAPDR data files
|   | for orbits between 'mmmm' and 'nnnn'.
|   |   |- L0mmmm.001 LOSAPDR file for orbit number 'mmmm'.
|- [DOCUMENT] A directory containing document files
| relating to this disk.
|   |- DOCINFO.TXT Description of files in the DOCUMENT
|   | directory.
|   |- LOSAPDR.TXT A machine readable version of the LOSAPDR
|   | SIS document describing the format and
|   | content of the data files.
|   |- REPORT.ASC ASCII text version of REPORT.PS.
|   |- REPORT.LBL A PDS detached label describing REPORT.ASC & REPORT.PS.
|   |- REPORT.PS A PostScript document that gives specific
|   | information about each LOSAPDR after a
|   | quality check and validation.
|- [INDEX] A directory containing index files relating
| to this disk.
|   |- INDEX.LBL A PDS detached label describing INDEX.TAB.
|   |- INDEX.TAB Tabular summary of data files.
|   |- INDXINFO.TXT Description of files in the INDEX directory.

```

#### 5. Recommended CD-ROM Drives and Driver Software

##### VAX/VMS

Drive: Digital Equipment Corporation (DEC) RRD40 or RRD50. Driver: DEC VFS CD-ROM driver V4.7 or V5.2 and up.

Note: The driver software may be obtained from Jason Hyon at JPL. It is necessary to use this driver to access Extended Attribute Records (XARs) on a CD-ROM.

##### VAX/Unix

Drive: DEC RRD40 or RRD50. Driver: Supplied with Unix 3.1.

Note: Internet users can obtain a copy of the "cdio" software package via anonymous ftp from the "space.mit.edu" server in the file named "src/cdio.shar". Contact Dr. Peter Ford at Massachusetts Institute of Technology for details (617 - 253-6485 or pgf@space.mit.edu).

##### IBM PC

Drive: Toshiba, Hitachi, Sony, or compatible. Driver: Microsoft MSCDEX version 2.2.

Note: The latest version of MSCDEX (released in February 1990) is generally available. Contact Jason Hyon for assistance in locating a copy.

##### Apple Macintosh

Drive: Apple CD SC (Sony) or Toshiba. Driver: Apple CD-ROM driver.

Note: The Toshiba drive requires a separate driver, which may be obtained from Toshiba.

Sun Micro (SunOS 4.0.x and earlier)  
Drive: Delta Microsystems SS-660 (Sony). Driver: Delta Microsystems driver or SUN sr.o Driver.

Note: For questions concerning this driver, contact Denis Down at Delta Microsystems, 415-449-6881.

Sun Micro (SunOS 4.0.x and later)  
Drive: Sun Microsystems. Driver: SunOS sr.o driver.

Note: A patch must be made to SunOS before the Sun driver can access any CD-ROM files containing Extended Attribute Records. A copy of this patch is available to Internet users via anonymous ftp from the "space.mit.edu" server in the file named "src/SunOS.4.x.CD-ROM.patch".

#### 6. Errata and Disclaimer

A cumulative list of anomalies and errors is maintained in the file ERRATA.TXT at the root directory of this volume.

Although considerable care has gone into making this volume, errors are both possible and likely. Users of the data are advised to exercise the same caution as they would when dealing with any other unknown data set.

Reports of errors or difficulties would be appreciated. Please contact one of the persons listed herein.

#### 7. Whom to Contact for Information

For questions concerning this volume set, data products and documentation:

Jim Alexopoulos  
Washington University Dept. of Earth and Planetary Sciences  
1 Brookings Drive  
Campus Box 1169  
St. Louis, MO 63130  
314-935-5365

Electronic mail address: Internet: jim@wuzzy.wustl.edu

For questions about how to read the CD-ROM:

Jason J. Hyon  
Jet Propulsion Laboratory  
California Institute of Technology  
4800 Oak Grove Drive MS 525-3610  
Pasadena, CA 91109  
818-306-6054

Electronic mail addresses:  
Internet: [jhyon@jplpds.jpl.nasa.gov](mailto:jhyon@jplpds.jpl.nasa.gov)  
NASAmail: JHYON  
NSI: JPLPDS::JHYON X.400:  
(ID: JHYON, PRMD: NASAMAIL, ADMD: TELEMAIL, C: USA)

For questions concerning the generation of LOSAPDR products:

William L. Sjogren  
Magellan Gravity Principal Investigator  
Jet Propulsion Laboratory  
California Institute of Technology  
4800 Oak Grove Drive MS 301-150  
Pasadena, CA 91109 818-354-4868

Electronic mail address:  
Internet: wls@nomad.jpl.nasa.gov

For questions concerning LOSAPDR data:

William L. Sjogren  
Jet Propulsion Laboratory Pasadena, CA

Dr. Roger J. Phillips  
Washington University Dept. of Earth and Planetary Sciences  
1 Brookings Dr. Campus Box 1169  
St. Louis, MO 63130 314-935-6356

Electronic mail address: Internet: phillips@wustite.wustl.edu

For questions concerning LOSAPDR labels:

Dr. Richard Simpson  
Stanford University  
Durand Bldg. Room 232  
Stanford, CA 94305-4055  
415-723-3525

Electronic mail address: Internet: rsimpson@magellan.stanford.edu

This disk was produced by Jim Alexopoulos.

## D.2 INDXINFO.TXT

Each PDS archive volume shall include an "INDXINFO.TXT" file in the INDEX subdirectory that contains an overview of the contents and structure of the index table or tables on the volume as well as usage notes. An example is provided here as guidance for compiling this file.

### D.2.1 Example

```
CCSD3ZF0000100000001NJPL3IF0PDSX00000001
PDS_VERSION_ID                = PDS3

RECORD_TYPE                    = STREAM
OBJECT                         = TEXT
NOTE                           = "Notes on using the image index tables."
PUBLICATION_DATE               = 1990-12-20
END_OBJECT                     = TEXT
END
```

#### NOTES ON USING THE IMAGE INDEX TABLES

These notes describe the contents and format of the two image index tables on this CD-ROM, INDEX.TAB and CUMINDEX.TAB.

The image index table (INDEX.TAB) contains one record for each image file on this Viking Orbiter CD-ROM. The cumulative image index table (CUMINDEX.TAB) contains one record for each image file on all the Viking Orbiter CD-ROMs published so far. The following description applies to both of these tables.

The image index tables are formatted so that they may be read directly into many database management systems on various computers.

All fields are separated by commas, and character fields are enclosed in double quotation marks ("). Each record contains 512 bytes of ASCII character data (1 character = 1 byte). Bytes 511 and 512 contain the ASCII carriage return and line feed characters. This allows the table to be treated as a fixed length record file on computers that support this file type and as a normal text file on other computers. The structure and content of the image index tables are described in the file VOLINFO.TXT located in the DOCUMENT directory. The files INDEX.LBL and CUMINDEX.LBL contain labels for INDEX.TAB and CUMINDEX.TAB coded in the Object Description Language (ODL), providing a formal description of the index table structure.

Users of most commercial database management systems should be able to use the list below to define the names and characteristics of each field and then to load the tables into their systems using a delimited ASCII text input format. If necessary the specific column start positions and lengths can be used to load the data.

For personal computer users, DBASE III DBF structures are also provided in the files INDEX.DBF and CUMINDEX.DBF. These files can be used to load the INDEX.TAB or CUMINDEX.TAB files into DBASE III or IV with the following commands:

```
USE INDEX
APPEND FROM INDEX.TAB DELIMITED

USE CUMINDEX
APPEND FROM CUMINDEX.TAB DELIMITED
```

Once the table is loaded into DBASE III, it can generally be automatically loaded into other data managers or spreadsheets that provide search and retrieval capabilities.

## D.3 SOFTINFO.TXT

Each PDS archive volume that contains software (in the SOFTWARE subdirectory) shall include a "SOFTINFO.TXT" file. This file contains a description of the software and usage information. An outline and example are provided here as guidance for compiling this file.

### D.3.1 Outline

- I. PDS TEXT Object (must appear in an attached or detached label)
- II. Contents
  1. Introduction
  2. Software Description
 

A brief description of software included on the volume. This can be broken down into separate sections for each type of software. This should indicate where the software and its documentation reside in the software hierarchy, as well as describe any known limitations or problems.
  3. Software Directory Structure (optional)
  4. Software License Information and Disclaimers (if appropriate)

### D.3.2 Example

```

PDS_VERSION_ID          = PDS3
RECORD_TYPE             = FIXED_LENGTH
RECORD_BYTES           = 80
OBJECT                  = TEXT
INTERCHANGE_FORMAT     = ASCII
PUBLICATION_DATE       = 1994-10-01
NOTE                    = "Description of software provided with the
                          Clementine CD-ROM set"
END_OBJECT              = TEXT
END
  
```

Clementine Software

#### 1. Introduction

This directory contains software that provides display and processing capabilities for the Clementine data archived on this CD-ROM set.

#### 2. Software Description

##### 2.1. Decompression Software

The PCDOS, MACSYS7 and SUNOS subdirectories all contain software which can be used to decompress the Clementine raw images. CLEMDCMP will decompress the raw image and output it into one of four formats:

- 1) decompressed PDS labeled file which contains PDS labels, the histogram object, and an

- image object, either the browse image or the full image
- 2) decompressed image file, no labels
- 3) a decompressed image in the GIF format
- 4) a decompressed image in the TIFF format

The source code is provided in the SRC subdirectory, of each platform subdirectory. Instructions on how to install and run the software is in the file CLEMDCMP.TXT in the DOC subdirectory, of each platform subdirectory.

Because the image decompression program, CLEMDCMP, requires a Discrete Cosine Transform (DCT) it may take several minutes to decompress an image on hardware platforms with slow processors. For example, in tests on a Macintosh IIci, the decompression takes approximately 4 minutes. CLEMDCMP has been tested on hardware platforms with processors, such as an Intel 486DX2/66-Mhz, and the decompression takes just several seconds.

## 2.2. Display Software

CLIMDISP in the PCDOS/BIN subdirectory is an image display and processing program. It can be used to display Clementine uncompressed images and histograms. See CLIMDISP.TXT in the PCDOS/DOC subdirectory for instructions on how to install and run the program.

Note: CLIMDISP currently can not create GIF formatted files for the Clementine images. Additionally, it can not read the version of GIF files created by the Clementine Decompression (CLEMDCMP) program which is also included on the Clementine EDR Archive CD-ROMs. If you wish to display Clementine images with CLIMDISP, generate a PDS format image file when decompressing with CLEMDCMP.

A special version of NIH Image, found in the MACSYS7/BIN subdirectory, will display PDS decompressed Clementine images. This program is stored in a Stuffit file which is in BinHex format. See IMAGE.TXT in the DOC subdirectory for instructions on how to install and run the program.

The Clementine EDR image files use the PDS label constructs RECORD\_TYPE = "UNK", and ^IMAGE = xxxxx <BYTES> to define the structure of the file. This form of the labels is not supported by the current versions of IMDISP and IMAGE4PDS that are widely distributed by the PDS. To read Clementine decompressed formatted files use the version of IMAGE and CLIMDISP programs that are supplied on this CD-ROM. The Clementine versions CLIMDISP and IMAGE have been tested only on the Clementine data products. No attempt has been made to determine if the Clementine program versions will work on any other PDS data product.

XV is a shareware program for displaying images. XV was written by John Bradley of the University of Pennsylvania. It is in a compressed tar file in the SUNOS/SRC subdirectory. See XV.TXT in the SUNOS/DOC subdirectory for instructions on how to decompress and untar this file. XV will not display PDS labeled files, but will display TIF and GIF formatted files.

The XV software, for image display on a sun/unix environment, is not able to read the Clementine PDS labeled files. If you intend to use XV as the display system for the Clementine data products, output GIF or TIFF images with the CLEMDCMP program.

## 2.3. SPICE Software

Included on one of the ancillary disks associated with this volume set is the Navigation and Ancillary Information Facility (NAIF) Toolkit and some additional NAIF software. The major component of the NAIF Toolkit is the SPICE Library (SPICELIB), a collection of portable ANSI FORTRAN 77 subroutines. Some of these subroutines are used to read the SPICE kernel files containing Clementine ancillary data, such as spacecraft position, spacecraft attitude, instrument orientation and target body size, shape and orientation. Other SPICELIB subroutines may be used to compute typical observation geometry parameters --



provides powerful scientific image and signal visualization and processing. A number of custom features were added to the MSHELL Image/Signal Processing Environment to support the Clementine Program. This software is included on one of the ancillary disks associated with this volume set, and will be under a subdirectory of the PCDOS directory.

### 3. Software Directory Hierarchy

The SOFTWARE subdirectories are based on hardware platforms. Under each platform subdirectory, the executables are in the BIN subdirectory, the source is in the SRC subdirectory and documentation on each program is in the DOC subdirectory. Each DOC subdirectory contains a file, SWINV.CAT which is part of the PDS Software Inventory describing software available within the Planetary Science Community. The contents of the SOFTWARE directory are shown below.

```
[SOFTWARE]
|
|-SOFTINFO.TXT
|
|- [PCDOS]
| |
| | |- [BIN]
| | |
| | | |-CLEMDCMP.EXE
| | | |-CLIMDISP.EXE
| | | |-CLIMDISP.HLP
| |
| | |- [SRC]
| | |
| | | |-CLEMDCMP.C
| | | |-PDS.C
| | | |-BITSTRM.C
| | | |-DECOMP.C
| | | |-HUFFMAN.C
| | | |-WRITEGIF.C
| | | |-PDS.H
| | | |-JPEG_C.H
| | | |-CLEMDCMP.MAK
| |
| | |- [DOC]
| | |
| | | |-CLEMDCMP.TXT
| | | |-CLIMDISP.TXT
| | | |-SWINV.CAT
| |
|- [MACSYS7]
| |
| | |- [BIN]
| | |
| | | |-CLEMDEXE.HQX
| | | |-IMAGE.HQX
| |
| | |- [SRC]
| | |
| | | |-CLEMDSRC.HQX
| |
| | |- [DOC]
| | |
| | | |-CLEMDCMP.TXT
| | | |-IMAGE.TXT
| | | |-SWINV.CAT
| |
|- [SUNOS]
| |
| | |- [BIN]
| | |
| | | |-CLEMDEXE.TZU
| |
| | |- [SRC]
| | |
| | | |-CLEMDSRC.TZU
| | | |-XV3A.TZ
| |
| | |- [DOC]
| | |
| | | |
```

```
| -CLEMDCMP.TXT  
| -XV.TXT  
| -SWINV.CAT
```

## **D.4 VOLDESC.CAT**

This file contains the VOLUME object, which provides a high -level description of the contents of an archive volume.

The VOLDESC.CAT file must be present at the root level of the archive volume. If the archive volume contains logical volumes, then a VOLDESC.CAT file must be present at the root level of each logical volume. See Section A.28 for more information on using the VOLUME object and for examples of the VOLDESC.CAT file.

**A**

AAREADME.TXT  
contents.....D-2  
example .....D-3

**F**

file specification and naming  
required file examples .....D-11

**I**

INDXINFO.TXT  
example .....D-8

**L**

logical volumes  
VOLDESC.CAT .....D-12

**R**

required files  
examples .....D-1

**S**

SOFTINFO.TXT  
contents.....D-9  
example .....D-9



# Appendix E. NAIF Toolkit Directory Structure

This appendix contains the software directory structure of the NAIF Toolkit for a SUN. It is an example of a platform-based model for a single platform. Note that the directory organization shown here does not strictly conform to the recommendations discussed in the *Volume Organization and Naming* chapter of this document.

## Chapter Contents

Appendix E.	NAIF Toolkit Directory Structure .....	E-1
E.1	NAIF Directory .....	E-2
E.2	TOOLKIT Directory .....	E-3
E.3	Using the NAIF Toolkit .....	E-12
E.4	NAIF's File Naming Conventions .....	E-13

## E.1 NAIF Directory

The NAIF directory contains one subdirectory, TOOLKIT. The TOOLKIT tree contains all of the files that make up the NAIF Toolkit.

(directory under which you installed the NAIF Toolkit)



## E.2 TOOLKIT Directory

The TOOLKIT directory contains the file *make\_toolkit.csh*. This is a C shell script that builds all of the object libraries and executables in the TOOLKIT.

(directory under which you installed the NAIF Toolkit)

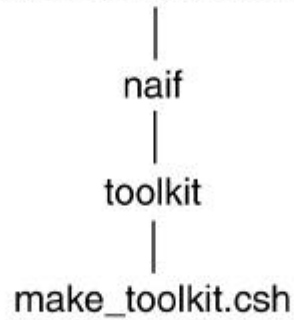

TOOLKIT also contains several subdirectories that will be described in more detail in the following sections.

(directory under which you installed the NAIF Toolkit)

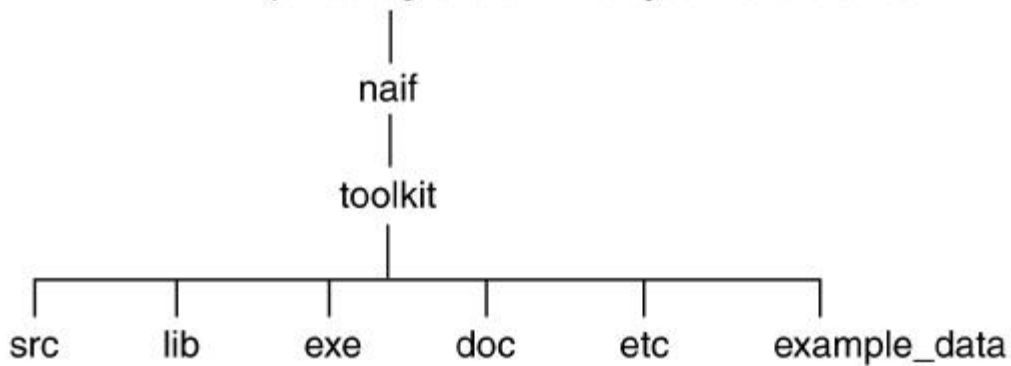

### 1. SRC

The subdirectories of this directory contain all of the source code for the products in the TOOLKIT.

### 2. LIB

This directory contains all of the TOOLKIT object libraries.

### 3. EXE

This directory contains all of the TOOLKIT executables, and where applicable, scripts to run the executables.



#### 4. DOC

This directory contains all of the TOOLKIT documentation. This includes user's guides for the programs, "Required Reading" files for SPICELIB, documents describing the contents of SPICELIB such as the "Permuted Index and Module Summary," and documents describing the contents and installation of the Toolkit.

#### 5. ETC

The subdirectories of this directory contain product-specific files that are neither source, documentation, nor data. These include configuration files, set up files, and help files. The subdirectory build contains the C shell script that creates the toolkit object libraries and executables.

#### 6. EXAMPLE\_DATA

This directory contains example data for use with the cookbook and *sptest* programs. These files are to be used only with these programs.

### E.2.1 SRC

The SRC directory contains one subdirectory for each product in the NAIF Toolkit. Each of these product directories contains the source code files and procedures to create the executable or object library.

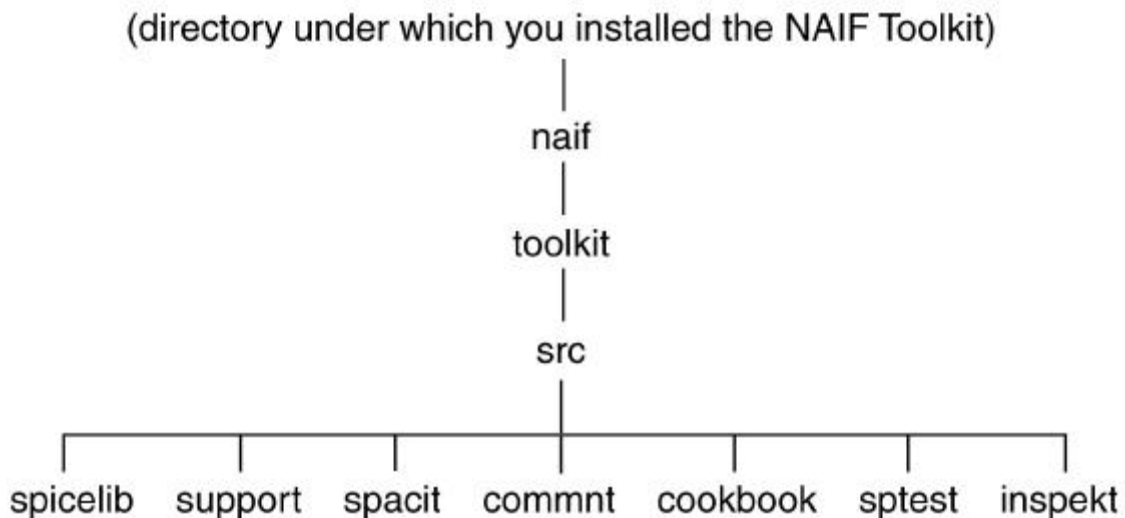

### E.2.1.1 SPICELIB

SPICELIB is a Fortran source code library that contains approximately 650 functions, subroutines, and entry points.

This directory contains the SPICELIB source files.

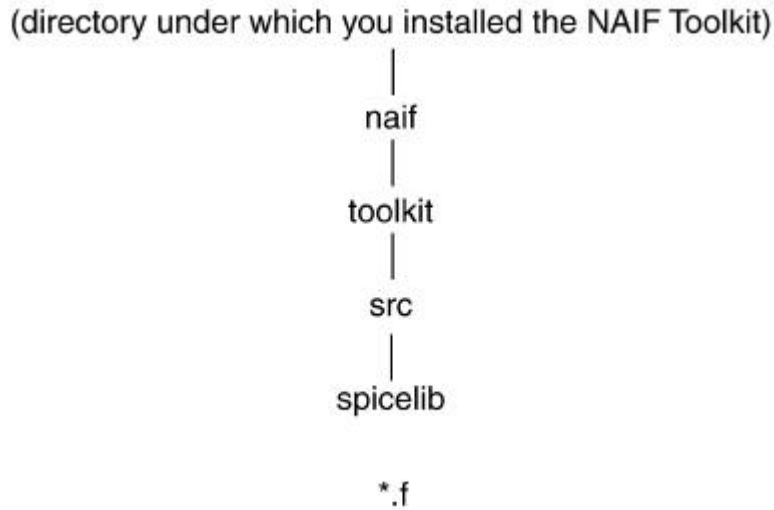

### E.2.1.2 SUPPORT

SUPPORT is a Fortran source code library that contains routines that support the Toolkit programs. These routines are not intended to be used by anyone except NAIF. These routines are not officially supported and may undergo radical changes such as calling sequence changes. They may even be deleted. Do not use them!

This directory contains the SUPPORT library source files.

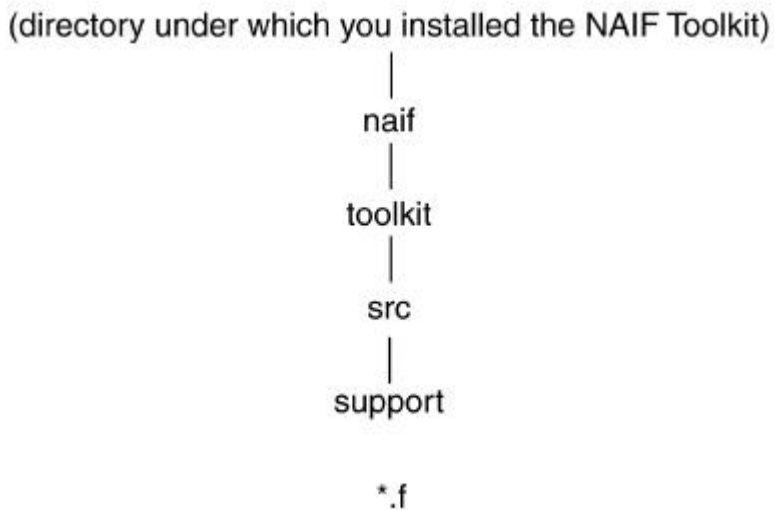

### E.2.1.3 SPACIT

*Spacit* is a utility program that performs three functions: it converts transfer format SPK, CK and EK files to binary format, it converts binary SPK, CK and EK files to transfer format, and it summarizes the contents of binary SPK, CK and EK files.

This directory contains the source code for the *spacit* main program and supporting routines.

(directory under which you installed the NAIF Toolkit)

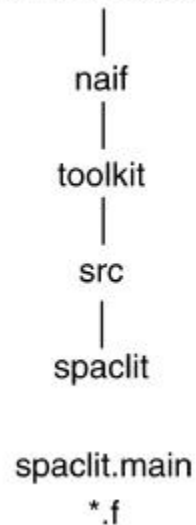

### E.2.1.4 COMMNT

*Commnt* is a utility program that is used to add comments, extract comments, read comments, or delete comments in SPICE SPK, CK and EK files.

This directory contains the *commnt* main program source file.

(directory under which you installed the NAIF Toolkit)

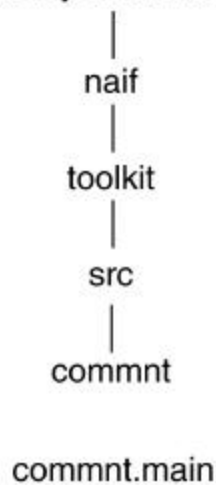

### E.2.1.5 COOKBOOK

The COOKBOOK programs are sample programs that demonstrate how to use SPICELIB routines to obtain state vectors, convert between different time representations, manipulate the comments in binary SPK and CK files , and solve simple geometry problems.

This directory contains the COOKBOOK program source files.

(directory under which you installed the NAIF Toolkit)

```
  |
  | naif
  | |
  | | toolkit
  | | |
  | | | src
  | | | |
  | | | | cookbook
```

```
fstspk.main
simple.main
states.main
subpt.main
tictoc.main
```

### E.2.1.6 INSPEKT

*Inspekt* is a program that allows you to examine the contents of an events component of an E-kernel.

This directory contains the source code for the *inspekt* main program and supporting routines.

(directory under which you installed the NAIF Toolkit)

```
|
naif
|
toolkit
|
src
|
inspekt
```

```
inspekt.main
*.f
*.inc
```

### E.2.1.7 SPTEST

*Sptest* is a utility program that tests the SPK file readers by comparing states read on the NAIF VAX with states read on the target machine.

This directory contains the *sptest* program source file.

(directory under which you installed the NAIF Toolkit)

```
|
naif
|
toolkit
|
src
|
sptest
```

```
sptest.main
```

### E.2.2 LIB

The LIB directory contains *spicelib.a*, the object library for SPICELIB. It also contains the object library *support.a*, but this library is for use by the Toolkit programs only. Do not link your applications with it!

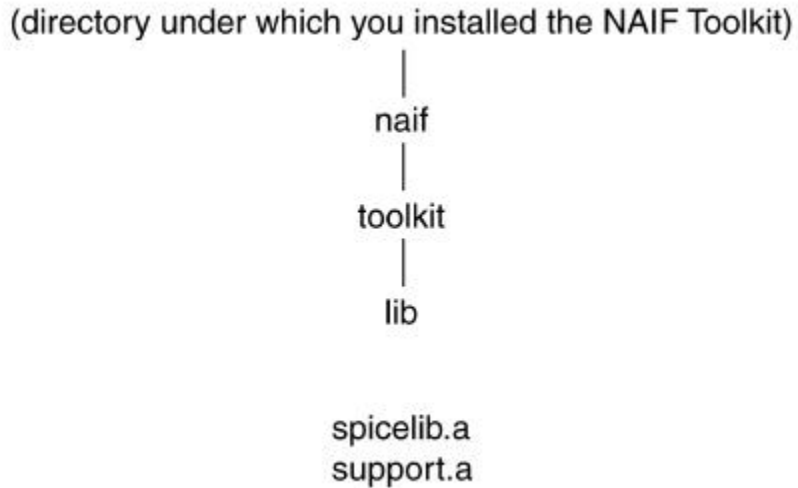

### E.2.3 EXE

The EXE directory contains the NAIF Toolkit executables and, where applicable, scripts to run executables.

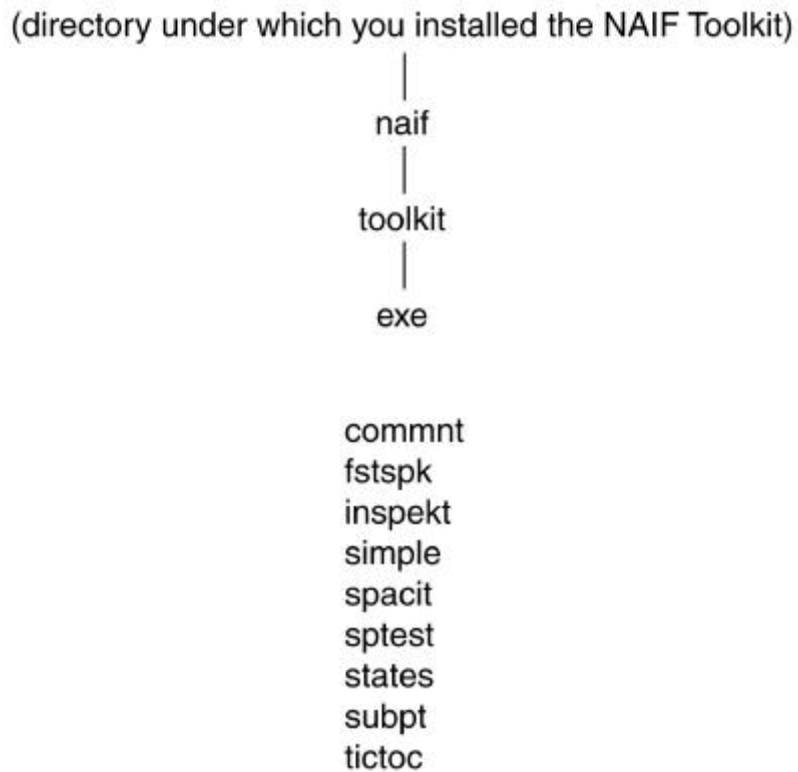

## E.2.4 DOC

The DOC directory contains all of the TOOLKIT documentation that is available on -line. This includes the user's guides for the programs, all "Required Reading" files for SPICELIB, all documents describing the contents and porting of SPICELIB, and documents describing the installation and contents of the Toolkit. Please note that the INSPEKT user's guide is not available on-line.

(directory under which you installed the NAIF Toolkit)

```
|
naif
|
toolkit
|
doc
```

```
commnt.ug
fstspk.ug
simple.ug
spacit.ug
sptest.ug
states.ug
subpt.ug
tictoc.ug
*.req
category.txt
libsum.txt
permuted_index.txt
porting.txt
toolkit_install.txt
toolkit_description.txt
```

## E.2.5 ETC

The ETC directory contains all files for the Toolkit products that are not source, documentation, or data such as set up files, configuration files or help files. It also contains the C shell script used to build the toolkit object libraries and executables.

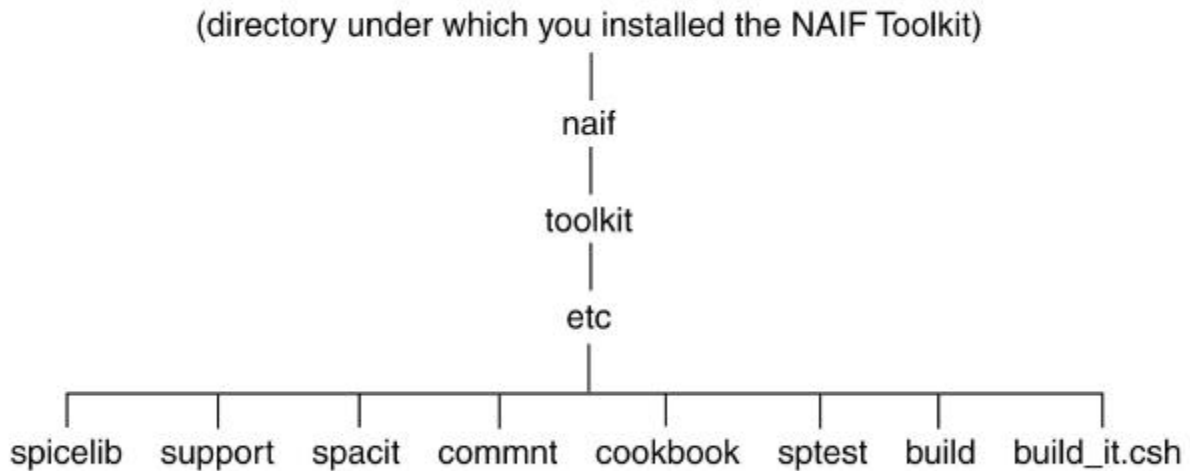

## E.2.6 EXAMPLE\_DATA

The EXAMPLE\_DATA directory contains all of the NAIF Toolkit data. This data are intended only to be used with the TOOLKIT programs, and are included only to help you get started using the Toolkit.

(directory under which you installed the NAIF Toolkit)

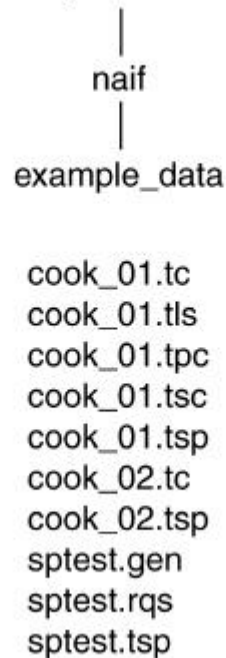



### **E.3 Using the NAIF Toolkit**

After the installation has been completed successfully, there are a few things that you need to do to get started using SPICELIB. We recommend that you print out the source code for the cookbook programs (*./naif/toolkit/src/cookbook/\*.main*) and examine it. Try running some of the cookbook programs yourself. The cookbook programs demonstrate how to use SPICELIB routines to obtain state vectors, convert between different time representations, manipulate the comments in binary SPK and CK files, and solve simple geometry problems.

Once you're ready to get your hands dirty, you should read the required reading files for SPICELIB. The required reading files are located in the directory *./naif/toolkit/doc* and have the extension ".req". They are text files that describe families of subroutines and how they interact with the rest of SPICELIB.

The most important required reading files are: TIME, KERNEL, SPK, CK, SCLK, SPC, and NAIF\_IDS. You should read at least these.

After you've done these things, you're ready to start programming with SPICELIB!

## E.4 NAIF's File Naming Conventions

NAIF follows a set of conventions for naming files based on the contents of the files. This allows you to find certain types of files in a directory tree quickly. The following table lists the current naming conventions.

*.for, *.f	Fortran-77 source code files
*.main	Source code files for program modules
*.inc	Fortran-77 include files
*.c	C source code files
*.o	Unix object files
*.obj	VAX/VMS object files
*.a	Unix object library files
*.olb	VAX/VMS object library files
*.tsp	Transfer format SPK (ephemeris) files
*.bsp	Binary format SPK (ephemeris) files
*.tc	Transfer format CK (pointing) files
*.bc	Binary format CK (pointing) files
*.ti	Text IK (instrument parameters) files
*.tls	Leapseconds kernel files
*.tpc	Physical and cartographic constants kernel files
*.tsc	Spacecraft clock coefficients kernel files
*.txt	Text format documentation files
*.ug	Text format User's Guides
*.req	Text format SPICELIB Required Reading files
make_toolkit.csh, build_it.csh	Unix C shell script files for creating the toolkit object libraries and executables
make_toolkit.sh, build_it.sh	Unix Bourne shell script files for creating the toolkit object libraries and executables
(product name)	Unix executable files. For example, spacit is the executable file for the product spacit
make_(product name).com	VAX/VMS command procedures for creating products. For example, make_spicelib.com creates the object library spicelib.olb, while make_spacit.com creates the executable spacit.exe.
(product name).exe	VAX/VMS executable files. For example, spacit.exe is the executable file for the product spacit.

These conventions are preliminary. As coordination with AMMOS and the Planetary Data System (PDS) occurs, these conventions may be revised.

**F**

file names  
NAIF conventions ..... E-13

**N**

NAIF  
file naming conventions ..... E-13  
NAIF Toolkit  
directory structure ..... E-1  
using ..... E-12

**S**

software directory structure  
NAIF ..... E-1  
SRC directory  
in NAIF distribution ..... E-4

## Appendix F. Acronyms

AGU	American Geophysical Union
AMMOS	Advanced Multi-Mission Operations System
ANSI	American National Standards Institute
ASCII	American Standard Code for Information Interchange
BNF	Backus-Naur Form
CCSDS	Consultative Committee on Space Data Systems
CDROM	Compact Disk Read-Only Medium
CD-WO	Compact Disk –Write Once
CODMAC	Committee on Data Management and Computation
CR/LF	Carriage Return/Line Feed (ASCII record delimiters)
DA	Data Administrator
DAT	Digital Audio Tape
DBA	Database Administrator
DE	Data Engineer
DIM	Digital Image Model
DN	Discipline Node
DTM	Digital Terrain Model
DVD(ROM)	Digital Video Disk (Read-Only Medium)
EBCDIC	Extended Binary Coded Decimal Interchange Code
ECR	Engineering Change Request
EDR	Experiment Data Records
ET	Ephemeris Time
GIF	Graphics Interface Format
GSFC	Goddard Space Flight Center (Greenbelt, Maryland)
HTML	Hyper-Text Markup Language
IAU	International Astronomical Union
IDS	Inter-Disciplinary Scientist
IRTM	Infrared Thermal Mapper
ISO	International Standards Organization
JD	Julian Date
JPL	Jet Propulsion Laboratory (Pasadena, California)
LSB	Least Significant Byte (or Bit) first
MSB	Most Significant Byte (or Bit) first
NAIF	Navigation and Ancillary Information Facility
NASA	National Aeronautics and Space Administration
NBS	National Bureau of Standards (now NIST)
NIST	National Bureau of Standards and Technology (formerly NBS)
NSI/DECNET	NASA Science Internet/DEC Network
NSSDC	National Space Science Data Center
ODL	Object Description Language

PCWG	Planetary Cartography Working Group
PDS	Planetary Data System
PI	Principal Investigator
PNG	Portable Network Graphics
PSDD	Planetary Science Data Dictionary
PVL	Parameter Value Language
RPIF	Regional Planetary Image Facility
SEDR	Supplementary Experimental Data Record
SFDU	Standard Formatted Data Unit
SGML	Standard Generalized Markup Language
SI	Systeme Internationale d'Unite – (International Standard for Units)
SIS	System Interface Specification
SPICE	Spacecraft, Planet, Instrument C -Matrix Events
SQL	Structured Query Language
UDF	Universal Disc Format
URL	Uniform Resource Locator
UTC	Universal Time, Coordinated
WORM	Write Once, Read Many (optical disk)
XAR	Extended Attribute Record

**A**

Acronym list  
Standards Reference ..... F-1

# Appendix G. SAVED Data

In rare cases data will be encountered in the PDS archive which are classified as having `ARCHIVE_STATUS = SAVED`. These data are being preserved in a primitive form either pending the production of an archive-quality product, or as part of a save-the-bits campaign for a defunct mission or project. In these cases the available information has been preserved in as close an approximation of PDS archive format as possible. Following is a description of the criteria applied to datasets considered for saving, and the PDS procedures applied during the process. It is provided here for information only – saved datasets are not considered acceptable for the purposes of meeting PDS archiving requirements.

## G.1 Safekeeping Process and Procedures

The decision to save a dataset will normally be made by the discipline node after discussion with the data provider. The decision may also be made by a data engineer at the Central Node after discussion with both the data provider and the most relevant discipline node(s). Preservation should take place according to the following procedures.

1. The details of every dataset to be saved will be discussed in a conference, such as a telecon or iteration of e-mail messages, among the data provider, the representatives of the relevant discipline node(s), and a data engineer from Central Node. This discussion will address:
  - a. The characteristics of the data to be preserved
  - b. The reasons for preserving rather than archiving the data
  - c. The timetable for producing an archival product from the preserved data
  - d. The proposed unique `VOLUME_ID` for the product
  - e. The extent of the additional information to be included
2. The conclusions of the decision-making conference will be summarized by the data engineer and distributed to all participants.
3. The dataset will normally be prepared and delivered by the data provider according to the agreed content and format.
4. The data engineer at the Central Node will ensure that the product is incorporated into the Distributed Inventory System (DIS).

## G.2 Safekeeping Standards

The following items are desirable for any preserved dataset. Some are required, as noted.

1. `VOLUME_ID` – This ID is required for every preserved product, must be unique within PDS, and must conform to the volume naming standards of PDS.

2. DIS.LBL – This label file is required for every preserved product and must conform to the PDS labeling standards.
3. AAREADME.TXT – This file describes the directory structure and the content of the volume. It also includes contact information for the original source of the data.
4. INDEX.TXT – This file is used if the individual data files do not have PDS labels. It consists of free format text and is a less rigorous version of INDEX.TAB.
5. Minimal labels – Individual files should be labeled with “minimal labels” as described in Section 5.2.3.
6. Document directory – This directory is optional but all files must have minimal labels.
7. Software directory – This directory is optional but all files must have minimal labels

Items 1 and 2 are absolutely required for all preserved datasets. Items 3 through 5, though not required, are strongly recommended for every preserved dataset. Items 6 and 7 are strongly recommended where appropriate.



**A**

AAREADME.TXT ..... G-2

**D**

Distributed Inventory System  
DIS.LBL ..... G-2

**I**

INDEX.TXT ..... G-2

**M**

minimal labels ..... G-2

**S**

safing data ..... G-1  
  criteria ..... G-1  
  procedures ..... G-1  
  standards ..... G-1  
SAVED data ..... G-1  
  G-1  
    G-1  
    **G-1**  
    **G-1**

**V**

VOLUME\_ID ..... G-1

# Appendix H. PDS Data Group Definitions

This section provides an alphabetical reference of approved PDS data group definitions used in labeling data objects. The definitions include descriptions, lists of required and optional keywords, and one or more examples of specific groups. For a more detailed discussion on data groups, see the *Data Objects / Groups* chapter in this document.

Data group definitions are refined and augmented from time to time, as user community needs arise, so object definitions for products designed under older versions of the Standards may differ significantly. To check the current state of any object or group definition, consult a PDS data engineer or either of these URLs:

PDS Catalog Search: **<http://pdsproto.jpl.nasa.gov/onlinecatalog/top.cfm>**

Data Dictionary Search: **<http://pdsproto.jpl.nasa.gov/ddcolstdval/newdd/top.cfm>**

The examples provided in this Appendix are based on both existing and planned PDS archive products, modified to reflect the current version of the PDS Standards. Additional examples may be obtained by contacting a PDS Data Engineer.

NOTE: Any keywords in the *Planetary Science Data Dictionary* may also be included in a specific data group definition.

## Chapter Contents

Appendix H.	PDS Data Group Definitions .....	H-1
H.1	PARAMETERS .....	H-3

## H.1 PARAMETERS

The PARAMETERS group provides a mechanism for grouping multiple sets of related parameters within a data product label. An alias, PARMS, exists for the PARAMETERS group.

See Chapter 13 of the Standards Reference for a complete description of GROUPS.

### H.1.1 Required Keywords

None

### H.1.2 Optional Keywords

1. psdd

### H.1.3 Example

The following label fragment shows the PARAMETERS group:

```

GROUP                                = COMMANDED_INST_PARAMETERS
  SHUTTER MODE                        = "BOTSIM"
  FILTER_NUMBER                       = 5
  FILTER_NAME                         = "L570-R570"
  EXPOSURE_DURATION                   = 1.05
END_OBJECT                            = COMMANDED_INST_PARAMETERS

GROUP                                = TELEMETRY_INST_PARAMETERS
  SHUTTER MODE                        = "AUTO"
  FILTER_NUMBER                       = 0
  FILTER_NAME                         = "CLEAR"
  EXPOSURE_DURATION                   = 0.773
END_OBJECT                            = TELEMETRY_INST_PARAMETERS

GROUP                                = TELEMETRY_PARMS
  SHUTTER MODE                        = "AUTO"
  FILTER_NUMBER                       = 0
  FILTER_NAME                         = "CLEAR"
  EXPOSURE_DURATION                   = 0.773
END_OBJECT                            = TELEMETRY_PARMS

```

**D**

data groups, H-1  
PARAMETERS, H-3

**G**

group definitions  
URL, H-1

**P**

PARAMETERS group  
alias, H-3  
definition, H-3  
PDS groups. *See* data groups

# PDS Standards Reference INDEX

## A

AAREADME.TXT .....	9-2, 19-8, A-126, G-2
contents .....	D-1
example .....	D-2
Acronym list	
Standards Reference.....	F-1
ALIAS object	
definition .....	A-3
aliases	
for data types.....	3-1
alternate time zone .....	7-4
ancillary data product	
contents .....	6-2
contents (diagram) .....	6-2
ancillary files.....	19-2
ancillary volume.....	19-2
archive quality	
data set .....	6-1
data set collection.....	6-1
ARRAY object.....	A-1, A-39
definition .....	A-4
ASCII files	
containing markup .....	9-4
format.....	9-3
record format.....	15-2
ASCII tables.....	A-105
AXIS_ITEMS .....	A-4
AXIS_NAME .....	A-83

## B

BAND_BIN .....	A-81
BAND_STORAGE_TYPE.....	A-68
BANDS.....	A-68
Bernoulli Disks	
delivery medium .....	11-1
binary data	
bit string format.....	3-6
integer formats .....	3-5
binary storage formats.....	C-1

binary tables .....	A-108
spare bytes .....	A-108
BINHEX utility .....	11-3
bit field representation .....	3-6
BIT_COLUMN object .....	A-20, A-108
definition .....	A-8
BIT_COLUMNS .....	3-6
BIT_DATA_TYPE	
standard values .....	3-1
BIT_ELEMENT object .....	A-1
definition .....	A-12
BIT_STRING .....	3-6
body coordinates	
prime meridians .....	2-1
spin axes .....	2-1
BYTES .....	A-18, A-58, A-105

<b>C</b>
----------

CALIB subdirectory .....	19-12
calibration data .....	6-2
calibration files .....	19-12
calibration subdirectory .....	19-12
CALINFO.TXT .....	19-12
CATALOG directory .....	B-1
catalog information .....	6-2
catalog object files .....	19-8
CATALOG object	
definition .....	A-13
catalog objects .....	B-1
DATA_SET .....	B-4, B-28, B-29
DATA_SET_COLL_ASSOC_DATA_SETS .....	B-11
DATA_SET_COLLECTION .....	B-13
DATA_SET_COLLECTION_INFO .....	B-16
DATA_SET_COLLECTION_REF_INFO .....	B-12
DATA_SET_HOST .....	B-4, B-5, B-18
DATA_SET_INFORMATION .....	B-4, B-19
DATA_SET_MAP_PROJECTION .....	B-23, B-27
DATA_SET_MAP_PROJECTION_INFO .....	B-26
DATA_SET_TARGET .....	B-29
DS_MAP_PROJECTION_REF_INFO .....	B-30
how to supply .....	19-9
IMAGE_MAP_PROJECTION .....	B-31
INSTRUMENT .....	B-37, B-49
INSTRUMENT_HOST .....	B-41, B-43, B-45
INSTRUMENT_HOST_INFORMATION .....	B-41, B-43

INSTRUMENT_HOST_REFERENCE_INFO .....	B-41, B-45
INSTRUMENT_INFORMATION .....	B-37, B-46
INSTRUMENT_REFERENCE_INFO .....	B-37, B-49
INVENTORY .....	B-50, B-52
INVENTORY_DATA_SET_INFO .....	B-52, B-53
INVENTORY_NODE_MEDIA_INFO .....	B-53
MISSION .....	B-54, B-59, B-60, B-61, B-62
MISSION_HOST .....	B-54, B-59, B-63
MISSION_INFORMATION .....	B-54, B-60
MISSION_REFERENCE_INFORMATION .....	B-54, B-62
MISSION_TARGET .....	B-63
PERSONNEL .....	B-64, B-66, B-67
PERSONNEL_ELECTRONIC_MAIL .....	B-64, B-66
PERSONNEL_INFORMATION .....	B-64, B-67
REFERENCE .....	B-28, B-68
SOFTWARE .....	B-75, B-77, B-78
SOFTWARE_INFORMATION .....	B-77
SOFTWARE_ONLINE .....	B-78
SOFTWARE_PURPOSE .....	B-79
TARGET .....	B-80, B-82, B-83
TARGET_INFORMATION .....	B-80, B-82
TARGET_REFERENCE_INFORMATION .....	B-83
catalog pointer .....	19-9
CATALOG subdirectory .....	19-8, 19-12
CATALOG.CAT .....	19-9
CATINFO.TXT .....	19-8
CD-Recordable	
delivery medium .....	11-1
CD-ROM	
delivery medium .....	11-1
formatting recommendations .....	11-2
premastering .....	11-2
CHECKSUM .....	A-70
citations .....	H-1
contents	
articles .....	H-2
books .....	H-2
CDs H-4	
DVDs .....	H-4
electronic journal articles .....	H-4
electronic publications .....	H-4
meeting papers .....	H-3
Internet sources .....	H-5
CITATION_DESC .....	B-21
example .....	B-5
formation rule .....	B-21



class word	
defined.....	6-7
CODMAC numbers.....	<i>See data processing level</i>
COLLECTION object.....	A-1, A-4, A-6, A-39
definition.....	A-16
COLUMN object.....	A-3, A-8, A-88, A-104
and CONTAINER.....	A-23
definition.....	A-18
vectors.....	A-18
COMPLEX.....	C-9
Compliance waivers.....	1-1
COMPRESSED_FILE.....	20-2
CONFIDENCE_LEVEL_NOTE	
headings.....	B-21
CONTAINER object.....	A-18
definition.....	A-23
in TABLE.....	A-121
CUMINDEX.LBL.....	19-11
CUMINDEX.TAB.....	19-11
cumulative index.....	19-11

## D

DAT tape	
delivery medium.....	11-1
data compression.....	20-1
Zip.....	20-1
example.....	20-3
file format.....	20-1
on archive volumes.....	20-3
data delivery	
media.....	11-1
data dictionary files.....	6-3, 19-13
PDSDD.FUL.....	19-13
PDSDD.IDX.....	19-13
See Planetary Science Data Dictionary.....	19-13
data elements	
data identification.....	5-15
descriptive.....	5-17
file characteristics.....	5-11
locally defined.....	5-19
proposing new.....	5-15
required and optional.....	5-11
standards identifiers.....	5-10
syntax	
summary.....	5-20

data files	
contents .....	19-10
record format .....	15-1
data identification data elements .....	5-15
data identification elements	
required for ancillary data .....	5-16
required for Earth-based data .....	5-16
required for spacecraft data .....	5-16
data objects .....	A-1
ALIAS .....	A-3
ARRAY .....	A-4
BIT_COLUMN .....	A-8
BIT_ELEMENT .....	A-12
CATALOG .....	A-13
COLLECTION .....	A-16
COLUMN .....	A-18
CONTAINER .....	A-23
DATA_PRODUCER .....	A-30
DATA_SUPPLIER .....	A-32
definition of .....	5-12
DIRECTORY .....	A-34
DOCUMENT .....	A-36
ELEMENT .....	A-39
FIELD .....	A-41
FILE .....	A-44
GAZETTEER_TABLE .....	A-48
HEADER .....	A-58
HISTOGRAM .....	A-60
HISTORY .....	A-63
IMAGE .....	A-67, A-77
INDEX_TABLE .....	A-72
object definition .....	5-17
PALETTE .....	A-77
QUBE .....	A-80
SERIES .....	A-88
SPECTRUM .....	A-93
SPICE_KERNEL .....	A-96
SPREADSHEET .....	A-99
standard data objects .....	5-17
TABLE .....	A-104
TEXT .....	A-126
VOLUME .....	A-128
data pointers .....	14-1
data processing level .....	6-7
CODMAC numbers .....	6-6
Data Preparation Workbook .....	1-1

DATA_PRODUCER object .....	A-32
definition .....	A-30
data product	
and PRODUCT_ID .....	4-1
definition .....	4-1, 6-2
file configurations .....	4-2
labels .....	5-1
label example .....	4-2
primary data object .....	4-1
relation to data set .....	6-1
relation to data set collection .....	6-1
secondday data object .....	4-1
data representation	
internal .....	C-1
data set	
contents .....	6-1
definition .....	6-1
naming and identification .....	6-3
processing level .....	6-7
relation to data products .....	6-1
reprocessed, version number .....	6-9
data set collection	
contents .....	6-1
contents (diagram) .....	6-2
definition .....	6-1
naming and identification .....	6-4
relation to data products .....	6-1
reprocessed, version number .....	6-9
data set type	
acronyms .....	6-7
DATA_SET object .....	A-44, B-18, B-19, B-28, B-29
definition .....	B-4
DATA_SET_COLL_ASSOC_DATA_SETS object	
definition .....	B-11
DATA_SET_COLLECTION object .....	B-11, B-12, B-16, B-17
definition .....	B-12
DATA_SET_COLLECTION_DESC .....	B-16
DATA_SET_COLLECTION_ID	
constituent components .....	6-4
data set type .....	6-7
description .....	6-8
example .....	6-10
standard acronyms and abbreviations .....	6-5
syntax .....	6-4
version number .....	6-9
DATA_SET_COLLECTION_INFO object	

definition .....	B-16
headings .....	B-17
DATA_SET_COLLECTION_NAME	
constituent components .....	6-4
example .....	6-10
DATA_SET_COLL_REF_INFO object	
definition .....	B-12
DATA_SET_DESC .....	B-1
headings .....	B-20
subheading formats .....	B-1
data set description	
acronyms .....	6-8
DATA_SET_HOST object	
definition .....	B-18
DATA_SET_ID .....	6-2, A-133, A-134, B-52
constituent components .....	6-3
data set type .....	6-7
description .....	6-8
example .....	6-9
satellite and ring names in .....	6-6
standard acronyms and abbreviations .....	6-5
syntax .....	6-4
version number .....	6-9
DATA_SET_INFORMATION object	
definition .....	B-19
DATA_SET_MAP_PROJECTION object .....	B-26 B-31
definition .....	B-23
DATA_SET_MAP_PROJECTION_INFO object .....	B-30
definition .....	B-26
DATA_SET_NAME	
constituent components .....	6-3
example .....	6-9
satellite and ring names in .....	6-6
DATA_SET_REFERENCE_INFORMATION object .....	B-4, B-5
definition .....	B-28
DATA_SET_TARGET object .....	B-4, B-5
definition .....	B-29
DATA_SET_TERSE_DESC	
example .....	B-5
DATA subdirectory .....	19-10
data submission .....	11-1
DATA_SUPPLIER object .....	A-30
definition .....	A-32
data type	
data elements .....	3-1
DATA_TYPE	

standard values.....	3-1
data types	
table of data element.....	3-2
table of standard values.....	3-4
date format	
conventional.....	7-2
native.....	7-2
precision.....	7-1
syntax.....	7-1
delivery media.....	11-1
description pointers.....	14-2
descriptive data elements.....	5-17
directories	
path names.....	8-4
reserved names.....	8-1, 10-3
standard directories.....	8-1
DIRECTORY.....	8-4
directory names	
and ISO 9660.....	8-2
syntax.....	8-2
directory naming.....	8-1
DIRECTORY object.....	A-130
definition.....	A-34
directory paths	
and ISO 9660.....	8-4
syntax.....	8-4
directory structure	
example.....	8-3
on sequential media.....	8-4
Distributed Inventory System	
DIS.LBL.....	G-2
DOCINFO.TXT.....	9-2, 19-12, A-126
DOCUMENT.....	9-2
ASCII version.....	A-36
DOCUMENT object.....	9-2
definition.....	A-36
DOCUMENT subdirectory.....	19-12, 19-13, 20-3
documentation.....	6-2, 9-1
and DOCUMENT object.....	A-36
ASCII file format.....	9-3
ASCII version.....	A-36
criteria for inclusion.....	9-1
example	
attached TEXT.....	9-5
detached.....	9-6
with graphics.....	9-6

file labelling	
DOCUMENT object, use of .....	A-36
format .....	9-1
HTML .....	9-1, 9-4
labels for .....	9-2
markup files .....	9-4
non-ASCII files .....	9-5
required ASCII format .....	9-1
TeX/LaTeX .....	9-1
validation .....	9-5
DS_MAP_PROJECTION_REF_INFO object	
definition .....	B-30
DVD media	
archive format .....	11-2
DVD-R	
delivery medium .....	11-1
DVD-ROM	
delivery medium .....	11-1
formatting recommendations .....	11-2
premastering .....	11-2
UDF .....	11-2

<b><i>E</i></b>
-----------------

EARTH_BASE_ID .....	B-37
ELEMENT object .....	A-1, A-6
definition .....	A-39
ENCODING_TYPE .....	9-5, 20-1
END statement .....	5-18, 16-5
Ephemeris time (ET) .....	7-4
ERRATA.TXT .....	19-8
Exabyte tape	
delivery medium .....	11-1
extensions	
table of .....	9-3
Extended Attribute Records (XARs)	
on delivery disks .....	11-2
EXTRAS subdirectory .....	19-13
EXTRINFO.TXT .....	19-14

<b><i>F</i></b>
-----------------

field delimiters .....	A-123
file characteristics data elements .....	5-11
file extensions	
reserved extensions .....	10-3

FILE object .....	20-2, A-34
definition .....	A-44
explicit .....	5-9
implicit .....	5-9, A-44
table of required and optional elements .....	A-45
FILE_NAME .....	5-12, A-44
file names .....	10-1
27.3 convention .....	10-2
8.3 convention .....	10-2
ISO 9660 Level 1 .....	10-2
ISO 9660 Level 2 .....	10-2
NAIF conventions .....	E-13
reserved extensions .....	10-3
reserved names .....	10-3
sequential file names .....	10-5
syntax .....	10-2
FILE_RECORDS .....	5-11
file specification	
definition .....	10-1
example .....	10-1
file specification and naming	
required file examples .....	D-11
FILE_STATE .....	A-81
FLOAT .....	C-6
floating point .....	3-6
floating point representation .....	3-6
FORMAT70 program .....	B-2
format specifications .....	3-6
for ASCII data files .....	3-6
for binary data files .....	3-6

<b><i>G</i></b>
-----------------

in HISTORY object .....	A-63
in QUBE.....	A-81
PDS use.....	12-16

## H

HEADER object.....	A-113
definition.....	A-58
secondary data object.....	4-1
HISTOGRAM object.....	A-81
definition.....	A-60
secondary data object.....	4-1
HISTORY object	
and QUBE.....	A-81
definition.....	A-63

## I

IEEE_COMPLEX	
storage format.....	C-9
IEEE_REAL	
storage format.....	C-6
IMAGE object.....	A-77, A-81
and PALETTE .....	A-77
compression .....	20-1
definition.....	A-67
primary data object.....	4-1
stored with TABLE object.....	A-120
IMAGE_MAP_PROJECTION object.....	A-81, B-23
definition.....	B-31
include files.....	19-15
include pointers.....	14-1
index files.....	6-3
INDEX subdirectory.....	19-10
INDEX_TABLE .....	19-11
contents.....	A-72
INDEX_TABLE object	
definition.....	A-72
INDEX_TYPE .....	A-72
INDEX.LBL.....	19-11
INDEX.TAB .....	19-11
INDEX.TXT .....	G-2
INDXINFO.TXT .....	19-10
example.....	D-8
INSTRUMENT object	
definition.....	B-37



INSTRUMENT_DESC.....	B-1
headings .....	B-46
subheading formats .....	B-1
INSTRUMENT_HOST object	
definition .....	B-41
INSTRUMENT_HOST_DESC,	
headings .....	B-43
INSTRUMENT_HOST_ID .....	B-37
INSTRUMENT_HOST_INFORMATION object	
definition .....	B-43
INSTRUMENT_HOST_REFERENCE_INFO object	
definition .....	B-45
INSTRUMENT_INFORMATION object	
definition .....	B-46
INSTRUMENT_REFERENCE_INFO object	
definition .....	B-49
INTEGER .....	C-1
integer representations	
least significant byte first (LSB) .....	3-5
most significant byte first (MSB) .....	3-5
signed vs. unsigned .....	3-5
INTERCHANGE_FORMAT .....	A-104
INVENTORY object	
definition .....	B-50
INVENTORY_DATA_SET_INFO object	
definition .....	B-52
INVENTORY_NODE_MEDIA_INFO object	
definition .....	B-53
ISIS Software	
QUBE object .....	A-80
ITEM_BITS .....	A-8
ITEM_BYTES .....	3-1, A-18
ITEM_OFFSET .....	A-8, A-18
ISO 9660	
Level 1 file names .....	10-2
Level 2 file names .....	10-2
ITEM_TYPE ( <i>obsolete</i> ) .....	3-1
ITEMS .....	3-1, A-8, A-18

<b><i>J</i></b>
-----------------

Jaz disks	
delivery medium .....	11-1

**K**

## KERNEL\_TYPE

table of file extensions .....	A-96
--------------------------------	------

**L**

## label files

contents .....	19-10
----------------	-------

LABEL_RECORDS .....	5-11
---------------------	------

LABEL_REVISION_NOTE .....	5-11
---------------------------	------

LABEL subdirectory .....	19-15
--------------------------	-------

labeling methods .....	5-1
------------------------	-----

attached .....	5-1
----------------	-----

case .....	5-3
------------	-----

combined detached .....	5-1
-------------------------	-----

detached .....	5-1
----------------	-----

example .....	5-1
---------------	-----

line lengths .....	5-3
--------------------	-----

labels .....	5-1
--------------	-----

and SFDU labels .....	5-11, 5-18
-----------------------	------------

attached .....	5-1
----------------	-----

case .....	5-3
------------	-----

character set .....	5-3
---------------------	-----

combined detached .....	5-1, 5-6
-------------------------	----------

descriptive text pointers .....	5-17
---------------------------------	------

detached .....	5-1
----------------	-----

END statement .....	5-18
---------------------	------

FILE object, explicit .....	5-9
-----------------------------	-----

FILE object, implicit .....	5-9
-----------------------------	-----

format .....	5-3
--------------	-----

character set .....	5-3
---------------------	-----

line length .....	5-3
-------------------	-----

minimal .....	5-8, 5-9
---------------	----------

Object Description Language (ODL) .....	5-1
---	-----

object pointers .....	5-12
-----------------------	------

attached label examples .....	5-14
-------------------------------	------

detached label examples .....	5-15
-------------------------------	------

padding .....	5-3
---------------	-----

## pointers

to data objects .....	5-12
-----------------------	------

to descriptive text .....	5-17
---------------------------	------

to structure files .....	5-17
--------------------------	------

standard data objects .....	5-17
-----------------------------	------

standards identifiers .....	5-10
-----------------------------	------

## structure

attached and detached .....	5-4
attached/detached example .....	5-5
combined detached .....	5-6
combined detached example .....	5-7
minimal .....	5-9
minimal example .....	5-10
structure pointers .....	5-17
LABINFO.TXT .....	19-15
least significant byte first (LSB) storage format .....	C-3
line terminators and delimiters	
vis-a-vis byte counts in objects	
exclusion of line terminators and delimiters in objects .....	A-18
LINE_DISPLAY_DIRECTION .....	A-68
LINE_FIRST_PIXEL .....	B-31
LINE_LAST_PIXEL .....	B-31
LINE_PREFIX_BYTES .....	A-67
LINE_SAMPLES .....	A-67
LINE_SUFFIX_BYTES .....	A-67
LINES .....	A-67
locally defined data elements .....	5-19
control authority .....	5-21
custodians .....	5-21
examples .....	5-19
identification of .....	5-21
justification for .....	5-19
namespace .....	5-21
review and use .....	5-21
scope of use .....	5-19
locally defined data elements .....	19-13
data dictionary files .....	19-13
local time .....	7-4
LOCAL_TIME .....	7-4
logical volumes	
multiple logical volumes (definition) .....	19-1
naming .....	19-19
single logical volume (definition) .....	19-1
VOLDESC.CAT .....	D-12
LOGICAL_VOLUME_PATH_NAME .....	A-133, A-134
LOGICAL_VOLUMES .....	A-133, A-135
LSB integers .....	<i>See</i> integer representations
LSB_BIT_STRING	
storage format .....	C-16
LSB_INTEGER	
storage format .....	C-3
LSB_UNSIGNED_INTEGER	
storage format .....	C-5

<b>M</b>
----------

MAC_COMPLEX .....	C-9
MAC_INTEGER .....	C-1
MAC_REAL .....	C-6
MAC_UNSIGNED_INTEGER .....	C-2
Management Council .....	1-1
MAP_PROJECTION_DESC	
headings .....	B-26
map resolution .....	2-5
MAXIMUM_SAMPLING_PARAMETER .....	A-88
MEDIUM_FORMAT .....	A-130
MEDIUM_TYPE .....	A-130
minimal labels .....	5-8, 5-14, G-2
MINIMUM_SAMPLING_PARAMETER .....	A-88
MISSION object .....	B-59, B-60, B-62, B-63
definition .....	B-54
MISSION_DESC	
headings .....	B-61
MISSION_HOST object	
definition .....	B-59
MISSION_INFORMATION object	
definition .....	B-60
MISSION_OBJECTIVES_SUMMARY	
headings .....	B-61
MISSION_REFERENCE_INFORMATION object	
definition .....	B-62
MISSION_TARGET object	
definition .....	B-63
most significant byte (MSB) first integers .....	C-1
MSB integers .....	<i>See integer representations</i>
and compressed data .....	20-2
contain no data object definitions .....	5-20
MSB_BIT_STRING	
storage format .....	C-15
MSB_INTEGER	
storage format .....	C-1
MSB_UNSIGNED_INTEGER	
storage format .....	C-2

<b>N</b>
----------

N/A constant .....	17-1
NAIF	
file naming conventions .....	E-13
NAIF Toolkit .....	A-96

directory structure .....	E-1
using .....	E-12
NAME .....	A-44
namespace .....	<i>See locally defined data elements</i>
NASA processing levels .....	<i>See data processing level</i>
native time	
examples .....	7-3
Not Applicable constant .....	17-1
NULL constant .....	17-1

## O

OBJECT .....	12-15
object definitions .....	1-3
format .....	5-17
URL .....	A-1
Object Description Language (ODL) .....	5-1
character set .....	12-3
comments .....	12-13
date and time formats .....	12-8
date formats .....	12-9
END statement .....	12-13
file format .....	12-13
identifiers	
reserved .....	12-12
syntax .....	12-11
implementation	
date and time .....	12-9
implementation notes .....	12-2
integer formats .....	12-6, 12-7
language summary .....	12-21
lexical elements .....	12-6
numeric values .....	12-17
Parameter Value Language (PVL) .....	12-25
PDS implementation .....	12-2
date and time .....	12-9
sets .....	12-21
symbolic literals .....	12-20
PVL guidelines .....	12-26
PVL restrictions on archive files .....	12-25
real number formats .....	12-7
revision notes .....	12-23
version 0 .....	12-24
version 1 .....	12-23
sample data label .....	12-1
sequences .....	12-20

sets.....	12-21
special characters .....	12-12
specification .....	12-1
statements.....	12-12
assignment .....	12-14
GROUP.....	12-15
OBJECT.....	12-15
pointer .....	12-14
symbol strings .....	12-11
symbolic literals.....	12-20
text string values .....	12-18
text strings.....	12-10
time formats .....	12-9
units of measure .....	12-17
object pointers.....	5-12
attached label examples .....	5-12
formats .....	5-12
syntax .....	5-13
objects .....	<i>See data object. See catalog objects</i>
generic.....	13-1
example.....	13-1
primitive.....	13-2
specific .....	13-1
example.....	13-1
standard objects.....	13-1
objects, data	
SERIES	
use of spare fields .....	A-125
SPECTRUM	
use of spare fields .....	A-125
observing campaign	
as MISSION.....	B-54

<b><i>P</i></b>
-----------------

PALETTE object .....	A-81
definition.....	A-77
secondary data object.....	4-1
Parameter Value Language (PVL).....	12-2, 12-25
PC_INTEGER.....	C-3
PC_REAL.....	C-9
PC_UNSIGNED_INTEGER.....	C-5
PDS catalog	
on-line search.....	H-1
references on-line.....	H-1
PDS objects.....	<i>See data objects. See catalog objects</i>

PDS Software Inventory .....	B-75
PDS_USER_ID .....	B-64
PDS_VERSION_ID .....	5-10
PERSONNEL object .....	B-66, B-67
definition .....	B-64
PERSONNEL_ELECTRONIC_MAIL object	
definition .....	B-66
PERSONNEL_INFORMATION object	
definition .....	B-67
physical media formats .....	11-1
physical media	
organization .....	19-1
Planetary Science Data Dictionary (PSDD) .....	1-1, 3-1, 5-1, 5-15, 5-17
file labeling .....	19-13
locally defined data elements .....	19-13
PDSDD.FUL .....	19-13
PDSDD.IDX .....	19-13
pointers	
catalog .....	19-9
data .....	14-1
in attached labels .....	14-1
in detached labels .....	14-1
description .....	14-2
include .....	14-1
rules for resolving .....	14-3
structure pointers .....	5-17
to descriptive text .....	5-17
use in labels .....	14-1
prefix or suffix data	
in QUBE object .....	A-86
in TABLE object .....	A-121, A-125
primary data object .....	
IMAGE object .....	4-1
SERIES object .....	4-1
SPECTRUM object .....	4-1
SPREADSHEET object .....	4-1
TABLE object .....	4-1
primitive data objects .....	A-1
primitive objects	
ARRAY .....	A-4
BIT_ELEMENT .....	A-12
COLLECTION .....	A-16
ELEMENT .....	A-39
processing level number .....	<i>See data processing level</i>
PRODUCT_ID .....	4-1, A-97

<b>Q</b>
----------

QUBE object	
and HISTORY object.....	A-81
definition.....	A-80

<b>R</b>
----------

REAL.....	C-6
RECORD_BYTES.....	5-11, A-111
record formats.....	15-1
blocking.....	15-1
FIXED_LENGTH.....	15-1
STREAM.....	15-2
UNDEFINED.....	15-3
VARIABLE_LENGTH.....	15-2
VAX counted byte strings.....	15-2
RECORD_TYPE.....	5-11,15-1, A-45
reference coordinates.....	2-1
body-fixed.....	2-2, 2-3
data elements.....	2-2
planetocentric.....	2-2, 2-3
planetographic.....	2-2, 2-3
ring systems.....	2-3
ring systems, data elements.....	2-4
reference frames	
B1950.....	2-1
standard inertial (J2000).....	2-1
REFERENCE object.....	B-4, B-5, B-12, B-30, B-45, B-49, B-62, B-83
definition.....	B-68
reference surface models.....	2-5
digital image model (DIM).....	2-5
digital terrain model (DTM).....	2-5
references	
citations.....	H-1
contents.....	H-2
on-line access to PDS cataloged.....	H-1
what to reference.....	B-68, H-1
REFERENCE_KEY_ID.....	B-5, B-12, B-28, B-30, B-45, B-62, B-83
relative time.....	7-4
REPETITIONS.....	A-24
required files	
examples.....	D-1
REQUIRED_STORAGE_BYTES.....	20-3
ROOT directory files.....	19-8
rotation direction	



of Solar System bodies.....	2-2
ROTATIONAL_ELEMENT_DESC	
headings .....	B-26
ROW_BYTES.....	A-112
ROW_PREFIX_BYTES.....	A-67, A-89
use .....	A-120
ROW_SUFFIX_BYTES.....	A-67
use .....	A-120

<b>S</b>
----------

safing data .....	G-1
criteria .....	G-1
procedures .....	G-1
standards .....	G-1
SAMPLE.....	A-77
SAMPLE_BITS .....	A-67
SAMPLE_DISPLAY_DIRECTION .....	A-68
SAMPLE_FIRST_PIXEL.....	B-31
SAMPLE_LAST_PIXEL .....	B-31
SAMPLE_TYPE.....	A-67
standard values.....	3-1
sampling parameter data	
in SERIES object .....	A-92
SAMPLING_PARAMETER_INTERVAL.....	A-88
SAMPLING_PARAMETER_RESOLUTION.....	18-1
SAMPLING_PARAMETER_UNIT .....	18-1
SAVED data.....	G-1
SCALING_FACTOR .....	A-70
sclk.....	<i>See spacecraft clock count (sclk)</i>
secondary data object.....	
HEADER object.....	4-1
HISTOGRAM object .....	4-1
PALETTE object .....	4-1
SEQUENCE_NUMBER.....	A-34, A-130
sequential media.....	A-34
SERIES object .....	A-18, A-111
definition.....	A-88
primary data object .....	4-1
TIME_SERIES .....	A-88
SOFTINFO.TXT.....	19-16, A-126
contents .....	D-9
example.....	D-9
software	
packaging for delivery .....	11-3
PDS inventory of tools and libraries.....	B-75

SOFTWARE object .....	B-77, B-78, B-79,
definition .....	B-75
software directory structure	
NAIF .....	E-1
software files .....	6-3
SOFTWARE subdirectory .....	19-16
SOFTWARE_INFORMATION object	
definition .....	B-77
SOFTWARE_ONLINE object	
definition .....	B-78
SOFTWARE_PURPOSE object	
definition .....	B-79
SOURCE_PRODUCT_ID .....	A-96
spacecraft clock count (sclk) .....	7-3
syntax .....	7-4
SPACECRAFT_ID .....	B-37
SPACECRAFT_CLOCK_START_COUNT .....	7-3, 7-4
SPACECRAFT_CLOCK_STOP_COUNT .....	7-3, 7-4
SPARE bytes .....	A-108, A-121
spare fields	
use in TABLE, SPECTRUM and SERIES objects .....	A-125
SPECTRUM object .....	A-18, A-111
definition .....	A-93
primary data object .....	4-1
SPICE kernels	
labelling .....	A-96
SPICE system	
kernel file extensions .....	A-96
SPICE_KERNEL object	
definition .....	A-96
SPREADSHEET object .....	A-96
CSV file format .....	A-100
definition .....	A-99
example .....	A-101
field delimiters .....	A-101
formats .....	A-101
primary data object .....	4-1
SRC directory	
in NAIF distribution .....	E-4
Standard Formatted Data Unit (SFDU) .....	5-11, 5-18
AMMOS usage .....	16-5
definition .....	16-1
examples	
FIXED_LENGTH file .....	16-8
STREAM file .....	16-8
UNDEFINED file .....	16-8

VARIABLE_LENGTH file.....	16-8
exceptions .....	16-9
I class .....	16-2, 16-6
K class.....	16-5
usage in PDS products .....	16-1
versions .....	16-1
Z class .....	16-2, 16-5
standards identifier data elements.....	5-10
START_BYTE .....	A-4, A-16, A-39, A-105
START_TIME .....	7-3, A-88
STOP_TIME .....	7-3, A-88
storage formats	
binary integers.....	3-5
STREAM .....	15-2
STRUCTURE pointer.....	A-109
STUFFIT utility .....	11-3
SUN_COMPLEX .....	C-9
SUN_INTEGER .....	C-1
SUN_REAL .....	C-6
SUN_UNSIGNED_INTEGER.....	C-2
Syquest disks	
delivery medium .....	11-1
Systeme Internationale d'Unites (SI) .....	18-1

<b><i>T</i></b>
-----------------

TABLE object.....	A-18, A-67, A-81
and CONTAINER.....	A-121
ASCII field delimiters.....	A-123
ASCII tables.....	A-105
binary tables .....	A-108
definition.....	A-104
INDEX_TABLE .....	A-72
more than one in a single file.....	A-117
PALETTE .....	A-77
primary data object .....	4-1
SERIES object .....	A-88
spare bytes.....	A-121
SPARE bytes.....	A-108
SPECTRUM object.....	A-93
stored with IMAGE object.....	A-120
STRUCTURE pointer.....	A-109
variations.....	A-111
tables	
multiple tables in single file.....	A-117
tape volumes .....	8-4

tar utility.....	11-4
target	
acronyms.....	6-5
named features.....	19-14
TARGET object.....	B-82, B-83
definition.....	B-80
TARGET_INFORMATION object	
definition.....	B-82
TARGET_NAME	
acronym list.....	6-5
TARGET_REFERENCE_INFORMATION object.....	B-80
definition.....	B-83
TEXT.....	9-2
text	
plain text formatting.....	A-126
TEXT object.....	9-2
definition.....	A-126
time format	
conventional.....	7-2
native.....	7-3
PDS standard time format.....	7-3
precision.....	7-1
syntax.....	7-1
time tags	
format.....	2-1
two's complement.....	C-1

<b><i>U</i></b>
-----------------

UNCOMPRESSED_FILE.....	20-2
UNCOMPRESSED_FILE_NAME.....	20-3
UNDEFINED.....	15-3
units of measure.....	18-1
default units.....	18-1
SI prefixes.....	18-2
SI units.....	18-1
supplementary units.....	18-3
symbols.....	18-1
Universal Time Coordinated (UTC).....	<i>See time format</i>
date/time formats, use in	
UTC, use of.....	7-4
in labels and catalog files.....	7-3
UNK constant.....	17-1
Unknown constant.....	17-1
UNSIGNED_INTEGER.....	C-2

<b>V</b>
----------

VARIABLE_LENGTH .....	15-2
VAX_BIT_STRING .....	C-16
VAX_COMPLEX	
storage format .....	C-15
VAX_DOUBLE .....	C-12
VAX_INTEGER .....	C-3
VAX_REAL	
storage format .....	C-12
VAX_UNSIGNED_INTEGER .....	C-5
VAXG_COMPLEX .....	C-15
VAXG_REAL	
storage format .....	C-12
version number .....	6-9
VICAR headers .....	A-58
VOLDESC.CAT .....	19-8, 19-19, A-13, A-130
VOLDESC.SFD .....	19-8
VOLINFO.TXT .....	19-12, 19-13, A-126
VOLUME .....	8-4, 19-8
volume	
ancillary volumes .....	19-2
definition .....	19-1
IDs .....	19-18
exceptions .....	19-20
logical volume naming .....	19-20
names .....	19-18
volume index .....	19-11
VOLUME object .....	A-13, A-30, A-32, A-34, A-44, A-133
definition .....	A-128
volume organization and naming .....	19-1
volume set	
definition .....	19-1
IDs .....	19-19
names .....	19-19
organization	
many data sets, many volumes .....	19-2, 19-7
many data sets, one physical volume .....	19-1, 19-6
many data sets, one volume .....	19-1, 19-5
one data set, many volumes .....	19-1, 19-4
one data set, one volume .....	19-1, 19-3
recommendations .....	19-7
types .....	19-1
VOLUME_FORMAT .....	A-130
VOLUME_ID .....	19-19, G-1
VOLUME_SET_ID .....	19-19

VOLUME\_VERSION\_ID ..... 19-19  
volumes, logical ..... 19-10

**W**

Waiver (compliance) ..... 1-1  
WORM disk  
  delivery medium ..... 11-1

**Z**

Zip compression ..... 20-1  
Zip disks  
  delivery medium ..... 11-1  
ZIPINFO.TXT ..... 20-3, 20-4